

30 March 1967

FOREWORD

This report by the NIGHT SONG study group reexamines the US tactical air campaign against the air defense system of North Vietnam, in response to the request of the Deputy Secretary of Defense on 10 January 1967.

Although the air campaign against the NVN air defense system encompasses a broad spectrum of operations in its own right, nevertheless it is but one integral part of the overall air campaign against the north, all other parts of which are also exposed to the NVN air defenses. Thus it was necessary that the examination of air defense matters be made within the larger context of that overall campaign.

The study group's comprehension of the subject was greatly enhanced by extensive visits to all air units, and discussions with commanders and staffs at all echelons fighting the war, from the squadron pilots to and including the Commander in Chief, Pacific.

It is apparent that North Vietnam has developed a highly competent and still-growing air defense system. Factors bearing upon this circumstance have been identified. They correlate with those which bear upon additional aspects of the enemy's willingness and ability to continue his war support despite the overall air campaign.

Specifically, he has expanded the capabilities of his air defense system faster than we have intensified the effectiveness of measures against it. This he has done while at the same time achieving substantial accommodations to other effects imposed by the overall air campaign, in other segments of the NVN national structure. Principal factor which has enabled him to do both of these is that his highest-capacity avenue for importation of war-supporting essentials has remained exempt from attack. Other restraints in our application of graduated pressures have contributed.

This study includes recommendations for improvements to US equipment, munitions, and tactical procedures which are required for continued air operations over NVN. These improvements can be introduced as they become available. They will enhance US air operations.

By themselves, however, those improvements will not be capable of assuring substantial or sustained improvement in our losses of aircraft to the enemy's air defenses. Nor will they be capable of bringing about a timely or decisive contribution toward a change in the enemy's estimation of his capabilities to outlast us in the war.

The report's principal message is that neither of the above purposes can be achieved without a coordinated campaign against complete enemy target systems, of which the most important single system is his total capability for importation of war-supporting essentials, air defense and other.

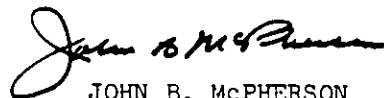

JOHN B. McPHERSON
MAJOR GENERAL, USAF
Chairman, NIGHT SONG Study Group

JOINT CHIEFS OF STAFF
OFFICIAL FILE COPY
JCS RAIR BRANCH 28030

~~SECRET - NOFORN~~

NIGHT SONG STUDY GROUP
REPORT (U)

AN EXAMINATION OF US AIR OPERATIONS
AGAINST THE
NVN AIR DEFENSE SYSTEM

VOLUME I

Regraded
Date
Authority

~~SECRET~~

30 MARCH 1979
800 5200.1-R

GROUP 3. DOWNGRADED AT 12
YEAR INTERVALS, NOT AUTO-
MATICALLY DECLASSIFIED.

SPECIAL HANDLING REQUIRED
NOT RELEASABLE TO FOREIGN
NATIONALS.

PREPARED BY:

CHAIRMAN,
NIGHT SONG STUDY GROUP
JOINT CHIEFS OF STAFF
30 March 1967

~~SECRET - NOFORN~~

JOINT CHIEFS OF STAFF
OFFICIAL FILE COPY
JCS RAIN BRANCH 2B030

~~SECRET~~

AN EXAMINATION OF US AIR OPERATIONS
AGAINST THE NVN AIR DEFENSE SYSTEM

TABLE OF CONTENTS

VOLUME I

BASIC REPORT

PART I - GENERAL

- A. Background
- B. Scope
- C. Method of Approach
- D. Basic Considerations

PART II - NORTH VIETNAM AIR DEFENSE SYSTEM

- A. General
- B. Radar
- C. Antiaircraft Artillery
- D. Surface-to-Air Missiles
- E. Air Defense Aircraft
- F. Command and Control
- G. Survivability
- H. Foreign Support

PART III - UNITED STATES AIR CAPABILITY IN NORTH
VIETNAM

- A. Weapons Systems and Munitions
 - 1. General
 - 2. Requirements
 - 3. Selected Items
- B. Tactics
 - 1. General
 - 2. Factors Shaping Tactical Operations
 - 3. Current Tactics--Related to Defenses and Mission
 - 4. Effect of Tactics on Attrition
 - 5. Tactics for FY 68/FY 69 and Subsequent

~~SECRET~~

C. Coordination and Control

1. General
2. Navy Procedures
3. Air Force Procedures
4. Marine Corps Procedures
5. Control Procedures

PART IV - DISCUSSION

A. General

B. Factors Leading to the Present Situation

1. US Objectives, Policy, and Major Operational Factors
2. NVN Objectives, Policy, and Air Defense Forces

C. Other Factors Related to US Air Operations in North Vietnam

1. US Intelligence
2. US Tactics
3. US Aircraft Attrition
4. US Air Munitions
5. Effects of Weather on US Air Operations
6. Coordination and Control of US Air Operations

D. Alternative Courses of Action

PART V - CONCLUSIONS AND RECOMMENDATIONS

A. Conclusions

B. Principal Recommendations

C. Intelligence

D. Special Intelligence

E. Strike Capability

F. Munitions

~~SECRET~~

- G. Electronic Systems
- H. Search and Rescue
- I. Coordination and Control
- J. Analysis

PART VI - GLOSSARY OF CODE NAMES

VOLUME II

APPENDIX A - GENERAL

- ANNEX A - Deputy Secretary of Defense Memorandum Requesting an Examination of US Air Operations Against the NVN Air Defense System
- ANNEX B - Implementing Directive and Terms of Reference
- ANNEX C - Composition of NIGHT SONG Study Group
- ANNEX D - Units Visited and Key Personnel Contacted
- ANNEX E - Glossary of Code Names

APPENDIX B - BASIC CONSIDERATIONS

APPENDIX C - DIGEST OF CONCEPTS AND RECOMMENDATIONS OF THE JOINT CHIEFS OF STAFF REGARDING AIR OPERATIONS AGAINST NORTH VIETNAM

APPENDIX D - NORTH VIETNAM AIR DEFENSE SYSTEM

- ANNEX A - Radar
- ANNEX B - Antiaircraft Artillery
- ANNEX C - Surface-to-Air Missiles
- ANNEX D - Possible Future Improvements in the Surface-to-Air Missile System
- ANNEX E - North Vietnam Air Force
- ANNEX F - Command and Control
- ANNEX G - Effectiveness of US Operations
- ANNEX H - NVN Weapons Effectiveness
- ANNEX I - An Analysis of NVN Air Defense Command and Control System as a Target System
- ANNEX J - Personnel and Training

~~SECRET~~

~~SECRET~~

ANNEX K - Weather Factors
ANNEX L - Logistics and Support
ANNEX M - Effects of Reduction of Importation
on NVN Air Defense
ANNEX N - System Deficiencies and Vulnerabilities
ANNEX O - Probable World Reactions to Expansion
of US Air Actions in North Vietnam
ANNEX P - Intelligence Gaps and Uncertainties
ANNEX Q - Conclusions
ANNEX R - Bibliography

APPENDIX E - WEAPON SYSTEMS AND MUNITIONS

ANNEX A - Aircraft
ANNEX B - Munitions
ANNEX C - Navigation and Sensors
ANNEX D - Electronic Warfare
ANNEX E - Enemy Electronic Counter Countermeasures
(ECCM) Summation

APPENDIX F - CURRENT TACTICS

ANNEX A - Future Tactics

APPENDIX G - COORDINATION AND CONTROL

ANNEX A - US Navy Operations
ANNEX B - US Air Force Operations
ANNEX C - US Marine Corps Operations
ANNEX D - Communications
ANNEX E - Coordination Procedures
ANNEX F - Fusion of US Air Control and Data
Processing System in Southeast Asia

APPENDIX H - ANALYSIS OF AN ANTI-ANTI-AIR CAMPAIGN
AGAINST NORTH VIETNAM

VOLUME III
(Available through SSO channels)

APPENDIX I - NORTH VIETNAM AIR DEFENSE SYSTEM

APPENDIX J - SPECIAL INTELLIGENCE SUPPORT TO US
AIR OPERATIONS

~~SECRET~~

~~SECRET~~

B. (S) SCOPE

1. The memorandum from the Deputy Secretary of Defense and the Terms of Reference from the Chairman, Joint Chiefs of Staff are broad in scope, encompassing the following:

- a. An analysis of the NVN Air Defense System;
- b. An analysis of the adequacy of military equipment and munitions as to quality and quantity;
- c. An analysis of tactics;
- d. An analysis of tactical command, control, and communications;
- e. An identification and analysis of differences in the tactical air problems of the Seventh Fleet and the Seventh Air Force;
- f. A consideration of other factors as determined during the course of the study.

2. At the start, the study group endeavored to limit its analysis to the application of US air operations against the NVN Air Defense System. However, it soon became apparent that operations against the NVN Air Defense System are so inextricably entwined with the total air campaign against North Vietnam that they are inseparable. For example, one could not design an interdiction campaign for the specific purpose of thwarting logistic support of the air defense system because material destined for support of that system usually cannot be identified from other material enroute in ships, trains, or trucks. It was necessary, therefore, to include in the analysis of US air operations against the NVN Air Defense System, the broader context of the over-all air campaign against North Vietnam.

3. From the outset of the study it was recognized that reduction of aircraft attrition--while pursuing an effective air campaign--was the primary problem to be addressed. Solutions to this problem were carefully considered. In studying equipment, tactics, and procedures and in arriving at each conclusion and recommendation, the question, "how will this affect US aircraft attrition?" was asked.

~~SECRET~~

~~SECRET~~

AN EXAMINATION OF THE US AIR OPERATIONS
AGAINST THE NVN AIR DEFENSE SYSTEM

PART I - GENERAL

A. (S) BACKGROUND

1. In a memorandum dated 10 January 1967, the Deputy Secretary of Defense requested a reexamination of the US tactical air campaign against the air defense system of North Vietnam. The memorandum is at Annex A to Appendix A.

2. At the direction of the Chairman, Joint Chiefs of Staff, the "NIGHT SONG" study group was formed to conduct the study. Major General John B. McPherson, USAF, Vice Director for Operations, J-3, OJCS, was appointed chairman and Rear Admiral Frederic A. Bardshar, USN, Chief, Requirements and Developments Division, J-5, OJCS, vice chairman of the study group. The Terms of Reference are at Annex B to Appendix A. The composition of the study group is shown at Annex C to Appendix A.

3. The Navy and Air Force each provided a group of officers and civilians whose knowledge and experience encompassed all areas of the problem. With the addition of a small nucleus of officers from the Joint Staff, the groups were combined into one and augmented with representatives of the Army, Marine Corps, Central Intelligence Agency, Defense Intelligence Agency, National Security Agency, and Weapons Systems Evaluation Group.

4. Following the compilation and study of pertinent initial data in Washington, 15 members of the study group visited PACOM Headquarters and subordinate commands directly engaged in the air war against North Vietnam. This group was divided into teams which visited all major air units in the Southeast Asia combat area. On scene information and impressions were obtained from commanders, staffs, and combat pilots at all echelons. A list of units visited and key personnel contacted is at Annex D to Appendix A.

~~SECRET~~

4. A properly conceived campaign against the air defense system may involve the coordinated application of all of these means. For instance, the best course of action may be to starve the SAM subsystem, destroy the MIGs, and neutralize the antiaircraft artillery (AAA) guns.

5. In studying alternatives, trade-off comparisons were made in terms of aircraft attrition. In general, it can be said that it becomes profitable to initiate a campaign against the enemy air defense system, or a part of it, if the losses suffered during the initial campaign on the air defense system, and in the new environment thereafter, are less than those which would have been suffered if such a campaign had not been conducted.

6. In mathematical terms this relationship may be expressed as follows:

$$AS \geq as (n + n') + A'S'$$

where A = attrition rate in the absence of a campaign against the air defense system.

S = total sorties

a = attrition rate in attacking the defenses

s = sorties to DESTROY (rather than neutralize) one defense unit

n = initial number of defense units

n' = defense units introduced

A' = attrition rate after completion of the air campaign against the air defense system

S' = sorties attacking other than defense targets.

~~SECRET~~

On an equal basis, however, the study group asked the question, "how will this improve our over-all effectiveness"?

4. The study was divided into three periods; prior to FY 68, during FY 68, and after FY 68.

C. (S) METHOD OF APPROACH

1. It should be noted that there has been no air "campaign" against the NVN Air Defense System. The major reasons that such a campaign has not been undertaken are:

a. With available non-nuclear weapons and equipment, the projected attrition of US aircraft would have been too high to justify a campaign against all of the NVN Air Defense System.

b. The existing political constraints which limit the scope of military air action reduce the effectiveness of such an air campaign to the point where the resultant trade off of US weapons systems for enemy systems would not be profitable. This is especially true when the enemy can resupply his losses with relative ease.

2. Parts of the air defense system have been attacked in connection with attacks on other designated targets and targets of opportunity. In addition, sorties have been tasked to search out and destroy SAMs and MIGs. These sorties have been more numerous lately but are not part of an integrated air campaign directed against the air defense system.

3. Some possible ways of conducting a campaign against the NVN Air Defense System are:

a. Destroy the system to the degree that its effectiveness is significantly reduced.

b. Neutralize the system by electronic or other means.

c. Starve the system by impeding the flow of air defense materiel into North Vietnam.

~~SECRET~~

PART II - NORTH VIETNAM AIR DEFENSE SYSTEM

A. (S) GENERAL

1. The NVN Air Defense System has been developed from a relatively rudimentary system in 1964 to a complex and modern system in 1967. The combination of MIGs, SAMs, anti-aircraft artillery (AAA), and the associated radar network in North Vietnam has degraded the effectiveness of the US interdiction effort. Because of the demonstrated successes and the constant threat of this network to US strike aircraft, the United States has had to invest ever increasing amounts of resources in combat support aircraft. In addition, US air commanders are forced to divert forces from strike efforts for flak and SAM suppression and combat air patrol (CAP).

2. Following is a synopsis of the assessment of the NVN Air Defense System. A more detailed assessment is included at Appendix C.

B. (S) RADAR

1. In the last two years, North Vietnam has developed a radar system providing early warning (EW) coverage and almost complete ground controlled intercept (GCI) capability for the entire country. AAA fire control and SAM missile control radars provide coverage for all vital areas of North Vietnam.

2. Because of an overlapping of radar coverage and significant duplication of equipment in most areas, North Vietnam has more than adequate protection in the volume of equipment; therefore, the quantity of EW and GCI radars imported in the future will probably be less than that imported in the past. Qualitative changes can be expected as more modern radars, particularly EW and GCI replace older types. Fire control radars for AAA will probably continue to show a quantity increase and SA-2 FAN SONG radars will be increased in number, along with any increases in SAM battalions.

7. All terms in the inequality are taken over the same time base.

8. The equation is oversimplified in that it fails to consider possible indirect effects of the defenses which may under some circumstances outweigh their direct impact in terms of losses. The loss of effectiveness in the air delivery of weapons while the pilot is under attack is one of the most serious indirect effects.

9. In addition to the three campaign possibilities stated previously, major over-all NVN air interdiction alternatives may be categorized as follows:

- a. Cease the bombing, either entirely or in part.
- b. Continue along present lines and within present constraints, but improve the equipment and techniques.
- c. Modify or lift the constraints.

D. (S) BASIC CONSIDERATIONS

1. Basic to any analysis of US air operations against North Vietnam is the consideration of several significant factors which have influenced operations to date and must be expected to influence operations in the future; whether directed against the over-all threat from North Vietnam or against the specific threat posed by its air defense system.

2. These significant factors can be grouped into four categories. The first involves a consideration of US military objectives, capabilities, and logistic requirements for conducting an air campaign. The second encompasses an analysis of enemy capabilities and logistic requirements to nullify the effect of US air operations, and the influence of this additional enemy effort upon his capability to direct or support the insurgencies in South Vietnam and Laos. The third involves consideration of the physical factors of the theater; weather, terrain, hydrography, national boundaries, distances, and base locations. The fourth deals with the consideration of US national objectives and high level decisions regarding the scope of the air war. Appendix B contains a discussion of these four groups of basic considerations.

obtain a launch capability at a field site. To detect possible SAM threats to B-52 operations, maximum attention is being devoted to the search for SAM facilities in the area of the DMZ.

3. Based on a review of SAM activity and operating characteristics since July 1965, and an estimate of NVN capabilities and intentions, it is estimated that the NVN SAM system will be expanded from the present 25-30 battalions to at least 40-45 battalions within the next two years. If this action is taken, the requirement for FAN SONG radars, launchers, control vans, and crews should be about doubled and the requirement for support areas would increase considerably. This would be a significant undertaking for North Vietnam. Thus far, the North Vietnamese have insisted on autonomous control and operation of their SAM system. Therefore, they would probably attempt the expansion with minimal Soviet operational assistance. Since missile expenditure would probably increase, the importation of missiles should be increased accordingly, thereby adding additional loads to the logistics and support systems. This 40-45 battalion strength would probably be used to provide air defense in major military and LOC areas. Four to five sites would be prepared per battalion to increase rapid relocation capabilities as a form of protection from air attack.

4. The increase in effectiveness which would be achieved through the introduction of a C-band SA-2 system or an SA-3 system is primarily in the area of low altitude intercept. A C-band system provides some frequency diversification for ECCM, possible increased missile maneuverability, and an increased ability to intercept lower altitude targets. The present aircraft attrition rate being achieved by AAAs on low altitude targets may reduce the need for a low altitude missile system. In addition, the SA-3 appears to have suffered development problems. Therefore, the probability that the C-band and SA-3 systems will be introduced is considered small.

L. (S) AIR DEFENSE AIRCRAFT

1. Although the NVN Air Force is not inflicting heavy losses on US aircraft, it does pose a threat to US air

C. (S) ANTI-AIRCRAFT ARTILLERY

1. The present AAA order-of-battle in North Vietnam reflects concentrations of weapons of multiple caliber which provide in depth protection to vital targets and lines of communication (LOC). The growth in AAA has been rapid; some fifteen fold since 1964. With the exception of heavy caliber guns, this growth rate is expected to decrease. An increased gun count in the southern regions of North Vietnam will probably be due partially to import and partially to relocation of weapons.

2. Russia has a variety of proximity fuzes. If these fuzes were introduced into North Vietnam, US losses to AAA would increase. Initial use of proximity fuzing in AAA is more likely to occur in the 85 and 100mm weapons. Since the 57mm AAA proximity fuze is relatively new, Russia may be reluctant to expose this fuze to compromise by using it in North Vietnam.

D. (S) SURFACE-TO-AIR MISSILES

1. Counting probables, the present SAM system (the SA-2, S-band) has accounted for nearly 50 aircraft shootdowns for over 1,700 missiles fired. The system has indirectly degraded the accuracy of US ordnance delivery and seriously impaired the ability of the United States to acquire aerial photography. The Red River delta area is protected in depth by missiles. This missile envelope over the essential military and logistics complexes located there, precludes photographic coverage of the volume and type that are needed for target planning and other intelligence. High flying U-2 aircraft and photographic drones, which have been providing good intelligence, are particularly vulnerable to the SA-2 missile. U-2s have been excluded from certain areas heavily defended by SAMs.

2. At the present time 161 fixed SAM sites are capable of accepting SA-2 firing units. These sites are located primarily in the Hanoi, Haiphong, Nam Dinh delta area and along coastal LOCs to the north and south. In addition to fixed sites the SA-2 system can be operated from hastily prepared field sites which are difficult to detect. A period of four to six hours is required to

F. (S) COMMAND AND CONTROL

1. Command and control has enhanced over-all performance of the NVN Air Defense System. US aircraft are faced with AAA and SAM defenses as soon as they penetrate the coast line from the east or enter the Red River and delta areas from the west. This indicates coordination between radar surveillance and weapons systems selection and command.

2. MIG interceptors operate against US aircraft during cloudy and clear weather and attack in a manner indicative of radar vectored intercepts. Although there have been occasions where MIGs, SAMs, and AAA were used simultaneously, this is not the usual case. It is evident that there is an element of control exercised wherein the air defense subsystems are coordinated in their application against US air attacks. Presumably a central Air Defense Headquarters is monitoring the air picture and directing the use of various air defense weapons systems.

G. (S) SURVIVABILITY

1. The North Vietnamese suffer from a lack of sufficient talent in technical areas. If North Vietnam chose or were forced to maintain its air defense system without external materiel and technical support, system effectiveness would soon be degraded.

2. On the other hand, North Vietnam is gaining daily combat experience in air defense. Early warning radar nets are becoming highly effective in detecting and tracking hostile targets.

3. Multiple radar sets provide for survivability in attacks and frequency diversification in a jamming environment. The density of varied caliber AAA weapons reduces the chances of suppression and provides overlapping envelopes of protection around military targets and lines of communication.

4. Command and control of weapons and other components within the air defense system are believed to be exercised through a radio system probably capable of variable frequency for a measure of protection against jamming. The

operations. The MIG threat makes it necessary to provide CAP aircraft which could otherwise be used for strike sorties. Strike pilots have been forced to jettison ordnance due to MIG encounters or indications of hostile intent, and pilot attention is distracted during ordnance delivery. New construction of fighter bases and airfield improvements are underway. Hoa Lac Airfield near Son Tay was photographed in March 1967 with five MIG-17s present, thus the field is ready for at least limited fighter operations. Kep shows signs of becoming a primary tactical base, and Bai Thuong, near Thanh Hoa, could soon be completed. The use of Bai Thuong would extend fighter interceptor capability over the southern regions of NVN land and off-shore areas and provide coverage for Laos and the northern regions of South Vietnam.

2. The NVN inventory of 114 jet fighters could increase. At least 32 MIG 15/17 replacements are now ready at Peitun/Yunnani, China. Use of MIG-21 and MIG-17 all weather interceptors could increase the night and adverse weather intercept capability of the NVN Air Force.

3. Aircraft of greater capability than the MIG-21 do not seem to be required for the defensive role now assigned to the NVN Air Force. The poor showing in combat, thus far, is probably more a factor of pilot technique than aircraft capability. The speed and maneuverability of the MIG-21 above 15,000 feet is comparable to the US F-4. The SU-7 FITTER would provide more speed and endurance; however, this alone would not give the enemy an immediate superiority advantage. Logistic and technical problems would increase with the introduction of a new generation of fighters, and pilot upgrade training would take considerable time.

4. The ATOLL air-to-air missile (AAM) is a copy of the US SIDEWINDER and with proper technique should perform comparably. The Russian ALKALI, beam rider, AAM presently used in some model MIGs is inferior to the US SPARROW. These Soviet missiles may not perform better on new Soviet jets since the basic aircraft weapons control systems are the same in the newer aircraft.

~~SECRET~~

the actual passage of aid to North Vietnam. Under conditions wherein the northeast rail lines, sea lanes, and port facilities are relatively immune from attack, external support to North Vietnam will probably continue to be sufficient to counter increased levels of US activity and continue to support the general development of the NVN Air Defense System.

~~SECRET~~

II-7

~~SECRET~~

relatively small geographic area involved does not demand radio equipment of large size requiring major power equipment. Such a radio system is extremely difficult to destroy or render ineffective.

5. The mobility of the SA-2, and the large number of prepared and unprepared locations from which missiles can be fired, provides the enemy with a highly flexible, effective air defense missile system.

6. Airfields and jet aircraft are vulnerable to attack. However, aircraft revetments, particularly covered revetments, provide protection for parked aircraft. The abundant labor force available could make rapid repairs to runway and airfield damage. Unhampered resupply of MIGs and logistics support could provide the NVN Air Force with a high degree of survivability. This would be especially true once the MIGs have been properly dispersed and protected by sheltered revetments.

H. (S) FOREIGN SUPPORT

1. The entire air defense system depends on foreign support. The Soviet Union and Communist China play vital roles not only in hardware and technical assistance but also in providing the means and routes of import. Without this support North Vietnam would be unable to adequately maintain or operate the present air defense system for a prolonged period. The capability of North Vietnam to expand and develop its air defense system, therefore, is primarily limited by the amount of support that the Soviet Union and Communist China are willing to invest in the war.

2. The capability of the Soviet Union to supply hardware and support material via overland routes to North Vietnam is, to an extent, affected by Sino-Soviet relations and the ability and desire of North Vietnam to "straddle the fence". China could deny or put obstacles in the path using the overland rail route through China. In this event, Russia might run the risk of a US confrontation on the high seas by shipping all military materiel by sea. While the problems of Sino-Soviet relations have been reflected in public quarrels over rail shipments, there is no evidence that they have affected

~~SECRET~~

controlled rate of production designed for cost effectiveness could shore up the US position for a long war and allow for quicker adaptations to weapons system changes. However, in this latter case the surge capability would be limited. Historically, new weapons have been more effective when their surprise and shock value have been properly exploited. If new weapons are introduced in small quantities when large quantities are needed, the enemy is able to adjust psychologically and to develop countermeasures before adequate and decisive pressure is placed upon him.

c. The munitions requirements submitted* by CINCPAC are considered valid. They reflect improved estimates based on more precise data than was previously available. The M-118 is one exception wherein the requirements seem unrealistically low. They appear to have been developed as a compromise between real requirements and allocations under a strict rationing program. CINCPAC allocations** are based upon the latest asset data available including on-hand, in transit, and scheduled production information. More detailed information is available at Annex B to Appendix E.

3. Selected Items

a. All-Weather Capability

(1) The need for more capability at night and during periods of adverse weather continues to grow. An analysis at Annex A to Appendix E, indicates that 66 percent more total sorties,

* CINCPAC 8000 ser 003 dated 3 Jan 67 (SECRET)
** CINCPAC 8000 ser 002133 dated 30 Dec 66 (SECRET)

~~SECRET~~

PART III - UNITED STATES
AIR CAPABILITY IN NORTH VIETNAM

A. (S) WEAPONS SYSTEMS AND MUNITIONS

1. General. The major aircraft, equipments, and munitions used by US forces in air operations against North Vietnam are described in detail in Appendix E. This section will discuss a few selected items that are recommended for accelerated production and introduction to combat, or are considered worthy of additional study. The present US capability to cope with or selectively destroy elements of the NVN Air Defense System has been significantly enhanced by the introduction of new aircraft, weapons, munitions, and electronic equipment not previously available. However, improvement is needed in the ability to accurately locate and destroy targets in adverse weather conditions. Equipment incorporating the techniques of Low Light Level Television (LLLTV) and Forward Looking Infrared (FLIR) are needed for detection, recognition, and destruction of targets at night. Navigation systems should be improved. Ground based radar coverage of North Vietnam should be extended.

2. Requirements

a. The development of force levels and munitions requirements, and the determination of production rates necessary to support expenditures and stock objectives, is a complex process. Changing technology and tactics of enemy and US forces cause many US plans to be less than optimum at the time of execution. For this reason current rates of expenditure do not necessarily provide an adequate base for determining future requirements.

b. A rapid inventory build-up would provide the tactical commander with a volume of munitions that he could use to pursue an aggressive campaign. However, the cost of carrying such an inventory would be high and there would be the risk of an obsolete surplus as a result of tactical or technological change. On the other hand, a continuous and

~~SECRET~~

as reticulated polyfoam and alternate mechanical flight controls, indicate great promise of reducing aircraft attrition and/or increasing aircrew recoveries. Such modifications, where feasible, should be expedited without delay.

c. Improved Bombing Systems. Circular error of probability (CEP) for non-nuclear ballistic ordnance is not as small as desired. Various programs and modifications to existing aircraft systems are proposed to remedy this situation. For example, THUNDERSTICK II is a proposed modification to the F-105 (with applicability to the A-7D), which should improve visual bombing CEPs by a factor of two to three. Further, THUNDERSTICK II would improve the F-105 all-weather bombing capability by using a Loran C/D receiver in conjunction with an improved inertial platform. The Navy has a program with Westinghouse, to design an improved air-to-ground aiming and bomb release computer and sight system for the F-4. Experiments are being conducted with a Laser system utilizing the basic principle of beam guidance for the ordnance item, and combining Laser ranging with LLLTV. The Naval Ordnance Test Station, China Lake is testing an IR target acquisition tracking system combined with radar ranging. The total effort has resulted in a better understanding of the difficulties inherent in the design of an extremely accurate weapon delivery system.

d. SHRIKE/Standard ARM (Air-to-Surface Anti-Radiation Missile). Early production models of SHRIKE were introduced in Southeast Asia for combat evaluation. The measurement of effectiveness was difficult to assess because the small warhead hampered visual verification of hits. There have been indications of success as a SAM radar locator and suppressor; evidenced by enemy changes in tactics. SHRIKE is a popular weapon with combat pilots and the improved anti-radiation missile, Standard ARM, is eagerly awaited. Standard ARM will include offset launches to spoof the enemy, extended range, and a superheterodyne receiver to provide increased sensitivity. The proposed* phase down of SHRIKE procurement for Southeast Asia from a total of 8,320

* JCS 1725/613-5 of 7 Mar 1967

resulting in a 20 percent increase in the A-6 sortie rate, can be obtained by increasing Navy A-6 squadron strength from 9 to 12 aircraft. CINCPAC considers that 15 aircraft are desirable and may prove to be even more cost effective than the estimates indicated above. The need for improvement in the A-6 weapon system cannot be ignored; however, the improvement program should not interfere with approval of the proposed Navy program.*

(2) The Air Force is currently testing the feasibility of using the RB-58, which has a night all-weather capability, as a pathfinder and/or attack bomber. If the tests are successful, the RB-58 could probably be deployed before the end of FY 67. The Air Force is also considering a proposal to deploy a detachment of six F-111A MK II aircraft in early FY 68. The F-111A MK II is designed for a night and all-weather weapon delivery capability and high-speed penetration at low altitudes.

b. Aircraft Survivability. In the design of currently operational aircraft, insufficient emphasis was placed on survivability in an anti-aircraft gun environment. Attrition statistics clearly portray the vulnerability of US tactical aircraft to small arms, automatic weapons and light AAA. The major causes of aircraft lost to AAA have been attributed to fire and loss of flight controls. The technology now exists (See Annex A to Appendix E) to reduce these causes. The feasibility and cost effectiveness of aircraft modification, or redesign prior to production, should be evaluated. Modifications, such

* Navy Department PO 69

The Joint Chiefs of Staff* recommended the following schedule for Standard ARM:

<u>STANDARD ARM</u>	<u>Jan 67</u>	<u>Jul 67</u>	<u>Dec 67</u>	<u>CY 67</u>
Production	0	0	40	100
Desired Expenditure**	0	0	80***	90***
Forecast Expenditure	0	0	80***	90***

The Joint Chiefs of Staff recommended that a phase down of SHRIKE production commence in July 1968, with a substitution of Standard ARM, Mod 1 and Mod 2, on a one-for-one basis. The JCS cumulative tactical trade-off reduced the SHRIKE buy by 1,280 missiles; replacing them by 620 Mod 1 and 660 Mod 2 Standard ARMS (for more precise details see Standard ARM, Annex B, Appendix E).

e. WALLEYE. (Air-to-Surface TV Guided Missile). The WALLEYE has now been employed in North Vietnam (seven firing in March 1967). The accuracy results were impressive (six direct hits and one probable hit out of seven fired) and because of previous evaluation the level of confidence in the system is high. As with any new weapon, production and delivery should be expedited as rapidly as possible to fully exploit its capabilities before the enemy can develop countermeasures. CINCPAC's current estimate of requirements is for an expenditure of 600 WALLEYES per month; however, this may be short of actual requirements. CINCPAC should review this requirement. In the meantime the Navy should expedite

* JCS 1725/613-5, dated 7 March 1967.

** The Standard ARM may replace the SHRIKE on a one-for-one basis commencing with Mod 1. The JCS paper cited above was most specific that the first version of Standard ARM (Mod 0) was not considered a suitable substitute for SHRIKE.

*** This is an estimate based on numbers to be available. The JCS paper did not recommend precise expenditures by month. However, the implication was that the Mod 0 version of the Standard ARM should be tested and evaluated as quickly as possible.

to 7,040 units by the end of FY 68, with a comparable one-to-one substitution of the first 300 ARM missiles, is considered a valid initial action. The current schedules tabulated below and on the following pages for other munitions, are excerpts from CINCPAC requirements* and allocations.** Production schedules have been obtained from the Assistant Secretary of the Navy (I&L)*** and from the Program Managers in the Navy and Air Force Systems Commands. Item units have been indicated for three separate months (January, July, and December 1967) and the calendar year totalled to illustrate the difference between desired and forecast expenditures. For example, CINCPAC**** shows the following schedule:

<u>AGM-45 SHRIKE</u>	<u>Jan 67</u>	<u>Jul 67</u>	<u>Dec 67</u>	<u>CY 67</u>
Production	277	415	850	5,500
Desired Expenditure	600	600	600	7,200
Forecast Expenditure	265	350	355	3,825

- * CINCPAC 8000 ser 003 dated 3 Jan 1967 (SECRET)
- ** CINCPAC 8000 ser 002133 dated 30 Dec 1967 (SECRET)
- *** Memorandum by the Assistant Secretary of the Navy (I&L), Subject: Air-to-Ground Munitions Production Program dated 11 Jan 1967.
- **** CINCPAC Requirements for the SHRIKE are stated in Enclosure (1), CH-3, 2 Feb 1967, page 27, to CINCPAC 8000 Ser 002133, dated 30 Dec 1966.

(2) The use of CBU-24 is severely rationed due to the short supply. Production will not reach the CINCPAC desired expenditure rate of 8000 bombs per month until about March 1968. Present production is 570 per month. Production has been accelerated to the maximum rate with 25 contractors involved. Following the approval of additional funding, it is estimated that it will take approximately 14 months lead time before monthly production rates can exceed 8,000 bombs per month. A 16,000 bombs per month production rate could be achieved in approximately 18 months from date of approval of funds.

(3) The CINCPAC requirement for 8,000 per month does not provide for potential PRACTICE NINE requirements or campaigns against MIG air-fields. Efforts should be made immediately to expand the production and loading facilities for CBU-24/29 bombs to cover the increasing requirements. The CBU-29, has a distribution of random delay fuze options. Present plans to procure one CBU-29 to three CBU-24s, should be continued under any expanded program. Current production/expenditure plans are:

<u>CBU-24</u>	<u>Jan 67</u>	<u>Jul 67</u>	<u>Dec 67</u>	<u>CY 67</u>
Production	520	2200	7450	32,640
Desired Expenditure	8050	8050	8050	96,600
Forecast Expenditure	700	1475	2100	16,550

g. BLU-31B (750 lb. Penetration Bomb/Mine with FMU-30/B time delay pressure sensing fuze). Future increased requirements for this weapon are supported by the area denial concepts set forth in this study. Possible PRACTICE NINE requirements are being considered. CINCPAC requirements are for 1500 per month. The BLU-31 will replace the MLU-10 on a one-for-one basis. The present contractor (United States Steel) is under contract for only 200 per month. In view of the CINCPAC requirement for 1500 per month, either a step-up in production by the prime contractor or

~~SECRET~~

current production and select a second source contractor as soon as possible, since the maximum capacity (500 items per month*) of the present contractor (Martin-Orlando) is below the existing CINCPAC requirement. Current delays in WALLEYE production are due mainly to the inability of a subcontractor to mass produce a gyro, even though they had successfully supplied it previously in small quantities to the Navy Avionics Facility, Indianapolis (NAFI). By the time production problems have been solved the second source contractor could be ready to produce, thereby allowing a more rapid build-up to meet an urgent requirement. Current schedules are:

<u>WALLEYE</u>	<u>Jan 67</u>	<u>Jul 67</u>	<u>Dec 67</u>	<u>CY 67</u>
Production	16	130	500	2800
Desired Expenditure	200	600	600	4800
Forecast Expenditure	0	221	445	2408

f. CBU-24/29. (Area Anti-Personnel/Materiel Cluster Bomb)

(1) According to pilot reports the CBU-24 has resulted in a significant reduction in flak activity around heavily defended targets. An analysis of tactical aircraft attrition, contained at Appendix H, indicates a marked decrease in aircraft loss rates after introduction of the QRC-160 and CBU-24. Since these equipments were introduced almost simultaneously into the Air Force inventory in Southeast Asia, it is difficult to quantify the exact percent reduction attributable to the CBU-24. However, the current introduction of CBU-24 into Navy inventory may provide additional data on the effectiveness of this weapon for flak suppression.

* Air Ammunition Directorate OASD (I&L) 30 Dec 1966

~~SECRET~~

III-7

FY 68. In view of possible increased expenditure requirements in support of the mining concepts set forth in this study and PRACTICE NINE, the forecast expenditures of this weapon should also be subjected to more thorough analysis.

k. Destructor MK-36 (Bomb/Fuze Modification). In August 1966, a development effort was initiated to provide a weapon with mine-like characteristics. The basic weapon chosen was the MK-82 with SNAKEYE fins; both of which are in ample supply. Procurement was authorized for 42,375 MK-36 destructor kits for modification of the MK-82. CINCPAC* established a requirement for 5000 units per month commencing with mid-summer 1967. Furthermore, CINCPAC has stated that this requirement may be increased by a substantial amount. Current production plans call for only 3600 per month after August 1967; therefore an increase in production should be negotiated immediately. Schedules are as follows:

<u>DESTRUCTOR MK-36</u>	<u>Jan 67</u>	<u>Jul 67</u>	<u>Dec 67</u>	<u>CY 67</u>
Production	0	2150	3600	21550
Desired expenditure	0	5000	5000	30000
Forecast expenditure**	0	1200	3000	12600
<u>MK-82</u>	<u>Jan 67</u>	<u>Jul 67</u>	<u>Dec 67</u>	<u>CY 67</u>
Production	140,000	140,000	140,000	1,680,000
Desired expenditure	92,909	96,774	97,155	1,145,133
Forecast expenditure	92,206	114,054	114,435	1,313,949

* CINCPAC msg R220215Z Mar 1967

** NIGHT SONG Study Group estimate

the selection of a second or even third source should be authorized as soon as possible. Schedules are as follows:

<u>BLU-31</u>	<u>Jan 67</u>	<u>Jul 67</u>	<u>Dec 67</u>	<u>CY 67</u>
Production	0	200	200	2000
Desired Expenditure	1500	1500	1500	18000
Forecast Expenditure	200*	200	200	1200

h. BLU-34B (3000 lb. demolition bomb). The US Air Force has stated a requirement for a 3000 lb bomb. The OSD has indicated that the BLU-34 will be approved if it is compatible with Navy tactical aircraft in addition to Air Force aircraft. Navy qualification is expected to take a year to complete. The current estimate is that first delivery will be in September 1969 with a production rate of 5,000 to 12,000 per year. Pending production of the BLU-34, existing M118 stocks (5,694 as of March 1967) will be rationed. Scheduled expenditures are as follows:

<u>BLU-34/M118</u>	<u>Jan 67</u>	<u>Jul 67</u>	<u>Dec 67</u>	<u>CY 67</u>
Production	0	0	0	0
Desired Expenditure	Unknown at this time			
Forecast Expenditure	268	242	216	2892

i. BLU-42 (Anti-Personnel Mine with Trip Wire Fuze). The BLU-42 is scheduled for combat deployment in February 1968. The procurement program calls for 600 CBU-34/A (540 BLU-42/B mines per CBU) in FY 67, and 2,400 CBU-34/A's in FY 68. In view of possible increased requirements in support of the mining concepts set forth in this study and PRACTICE NINE, the forecast expenditures of this weapon should be subjected to more thorough analysis.

j. BLU-45 (Anti-Vehicle Land Mine). The BLU-45 is scheduled for combat deployment in July 1968. The procurement program calls for 1,100 CBU-33/A (30 BLU-45/B mines per CBU) in FY 67 and 1,400 CBU-33/A's in

* MLU-10

systems. All systems now in use depend upon a cooperative target. If no signal is received upon interrogation, the target transponder may be inoperative because of pilot selection or because of a malfunction. The target must then be reclassified as unknown and investigated further; probably relying upon visual identification.

(2) The lack of a reliable electronic positive identification system imposes a limitation on the firing range of both air-to-air and surface-to-air missiles. For air-to-air missiles, a visual identification pass must be conducted inside the maximum firing range of the missile. This results in a loss of the element of surprise and firings at least efficient ranges. To correct this deficiency, one of the most promising programs currently funded is TRISAT. This system uses a spectral analysis technique to detect and classify the modulations present on the radar signal returning from a specific target. These modulations are due to machinery vibrations, airframe vibrations, and frequency distortions caused by the rotating engine blades. The present state of development in receiver systems and computers indicates that successful development of this system is possible. A feasibility demonstration will be completed within the next 90 days. Another possibility may exist in the exploitation of optical and electro-optical techniques. These systems are limited to day VFR operations. However, a review of the engagements that have taken place indicates that a day VFR system slaved to the air intercept radar and capable of operation out to a range of 10 to 20 miles would be useful. Such systems are being examined and could probably be made available within three years. Other techniques are under development which employ such devices as stable clocks and time differential systems; however, they will be "friendly only" systems which require an operational transponder.

~~SECRET~~

l. TALOS ARM (Surface-to-Surface Anti-radiation Missile). This program offers a realistic input to the suppression and/or destruction of the NVN Air Defense System. There is no production authorized at this time, and the first unit cannot be delivered sooner than six months after program approval. A decision should be made as soon as possible to proceed with at least limited production.

m. Munition Dispensers. The Tactical Fighter Dispenser Munitions (TFDM) is presently designed for level flight delivery from relatively low altitude. Although this delivery mode is satisfactory in lightly defended areas, it is not desirable in high threat areas. Delivery from a higher altitude results in an unacceptable dispersion of weapons. Consideration should be given to developing a cluster package similar to the SUU-30/B used with the CBU-24, but compatible with weapons now used with the TFDM.

n. Low Light Level Television Systems (LLLTV). There are at least four different flyable versions of LLLTV. There are some speed restrictions on the present systems (in the neighborhood of 300 KIAS) because vibrations induced at higher speeds causes a loss of picture clarity. The equipment is heavy (about 600 to 700 pounds) and uses an external ordnance stores station. Considering the annual average weather in Southeast Asia and reducing the usable moonlight time appropriately, LLLTV could result in a 20 to 25 percent increase in available time for visual weapon delivery. LLLTV can be installed in almost all US tactical aircraft. Action should be taken to equip a limited number of selected aircraft for combat evaluation.

o. Identification, Friend or Foe (IFF)

(1) Positive identification of airborne targets is one of the most pressing problems in air warfare today. Systems capable of interrogating friendly airborne targets have recently been installed in F-4 aircraft deployed to Southeast Asia. Other aircraft and certain surface units can also interrogate the enemy SRO-2 and Cross-up

~~SECRET~~

direction for evasive action. The follow-on RHAW system will also provide an accuracy of $\pm 1^\circ$ in the homing mode. The ability to extend the RHAW system to perform against Pan L-band threat (SPOON REST and FLAT FACE radars) is also being pursued. The two shortcomings, principally range to target and accurate frequency selectivity ($+5$ mcs), will not be resolved by the follow-on system. Quick Reaction Capability contract studies and in-house experimentation, (e.g., re-reflection and bearing cotangent rate) have not provided a reliable and accurate means of determining range to target for RHAW systems. It should be noted that the inverse LORAN technique (TOA) has not been exploited in the RHAW field.

q. Emitter Location

(1) Tactical ELINT and passive electronic countermeasures (PECM) collection in the NVN environment is accomplished on an extremely limited basis. COMMANDO LANCE, BIG EYE, BIG LOOK, EB-66C, EA-3B, EA-1F, EA-6A, and EF-10B aircraft are used to provide MIG and/or SAM warning in support of strike operations over North Vietnam. The RA-5C, RB-47, EA-6A, EF-10B, TROJAN HORSE, and BLUE SPRINGS aircraft are configured for ELINT and/or COMINT collection. With the exception of BIG EYE, each of the aircraft listed above has a capability for ELINT and/or COMINT collection. The collective resources of these aircraft are capable of conducting interception, location, and recording of the emitters associated with NVN defense.

(2) Improvements are needed in the capability to locate these emitters accurately. The spatial degree of change between direction bearings required to obtain an accurate radar location is dependent upon: (a) the ground speed of the collector aircraft; (b) the duration of signal emission; (c) the ability to correlate bearings emanating from the same source; (d) receiver sensitivity and selectivity; and (e) calibration and stable cross over of direction finding antenna patterns. None of the collector aircraft have the capability singly to bring together all five major elements.

p. Radar Homing and Warning System (RHAW)

(1) Deployed RHAW systems in strike and attack aircraft permit automatic detection and instantaneous display of the direction and relative distance (by signal strength only) to pre-selected threat radars which operate in L, S, C, or X-band regions of the spectrum; throughout 360° in Air Force aircraft and 120° of the forward hemisphere in Navy aircraft. The APR-30 now in development will extend coverage to 360° for Navy aircraft. Operational tests in Southeast Asia of RHAW ancillary equipment (SEE-SAM) have resulted in modifications which allow the pilot to know whether or not he is the actual target when flying in formation in a multiple SAM environment. These modifications will preclude unnecessary evasive maneuvers, deviations from course, or maneuvers at lower altitudes where ground fire is hazardous. RHAW systems in Southeast Asia have four serious limitations:

(a) the 120° coverage for Navy aircraft;

(b) the inability to present an accurate range to the target radar;

(c) receiver techniques preclude frequency selectivity as an accurate and reliable parameter for effectively resolving, in the warning mode, one specific radar located within a high density of similar types; and

(d) Navy systems do not incorporate the ancillary SEE-SAM equipment to allow the pilot, when flying in formation within a SAM environment, to know whether or not he is the specific target.

(2) Follow-on SEE-SAM systems will include a quick reference display to the pilot whose aircraft is in the center line of the main beam of the S or C-band guidance radar. The unit will relate the strike aircraft's actual position in relation to the main beam, thus indicating a positive

~~SECRET~~

(3) The limitation on ground processing is due to wire recorders being available in the EB-66C only, and the lack of fidelity. The EA-3B has a multi-channel automatic tape recorder, but facilities are not available aboard the carrier for its ground read out and processing. EIG LOOK tape recordings are processed and analyzed at Danang immediately upon landing. The RA-5C ELINT collection data is taped completely and processed, analyzed, and bearings plotted by a special computer aboard the aircraft carrier. Complete mission read out and plotting is accomplished within 12-72 hours. EA-6A/EF-10B collection data is ground processed in a GSQ-41 Read-out Van immediately following the flight (3 hours). The RB-47 which normally performs one mission a month near North Vietnam requires its intelligence data to be processed in Japan. The basic limitation in ground processing is the time delay and lack of a single central processing center for timely correlation analysis.

(4) The RA-5C, BLUE SPRINGS, TROJAN HORSE, and the RB-47, have not contributed significantly to timely tactical enemy order of battle information primarily because of system limitations. With the exception of BLUE SPRINGS, which is limited by restricted receiver coverage and location capability, these systems do not possess a real time reporting capability.

(5) The collection of perishable intelligence is aggravated by: (a) the mobility of many NVN radars; (b) short duration emissions; (c) high signal density; (d) high density of NVN radar defense; (e) manual operation of equipment; (f) limited signal handling capacity of the airborne receiver and operator; (g) time consuming airborne signal analyzer; (h) insufficient geographical coverage; (i) insufficient collectors for sampling environment throughout any 24 hour period; (j) insufficient collector platforms available to support strike with SAM/MIG warnings as well as pure ELINT collection; (k) inability to accomplish search of the entire operating frequency of the NVN radars; and (l) excessive time delay between actual data collection and processing.

~~SECRET~~

(a) The BIG LOOK, EA-3B and EB-66C cannot attain the ground speed to cover the required spatial degree change when restricted to orbit patterns and when SAM signals are emitting for 15, 30, 60, or 120 seconds. This situation is aggravated by the time consumed to manually operate airborne intercept receivers and attempt to synchronize BRIGAND with the ground radar antenna rotation, while attempting cross identification between three airborne receivers. Correlation of bearings also requires accurate signal analysis of each radar finger print (e.g., PRF, PW, Sweep Rate). The concentration and time consumed by the electronics warfare operators to achieve these necessary objectives precludes accomplishing more than recognition and location of SAM signals in order to fulfill their primary mission of SAM warning. The remainder of the ELINT information is collected on wire or tape recorder for later analysis.

(b) For the EB-66C, the actual time devoted on station to intercept and locate the NVN air defenses in Route Package VIB is negligible. In order to resolve a family of direction bearings within the proximity of the target area--considering the EB-66C orbit distance (40 nm) as well as its ground speed--a trade-off must be made. The aircraft can obtain a 5-15 nm CEP location of the SAM or any other target radar after a 6-10 minute extended orbit leg, but for the same period of time it would not be able to utilize its S-band jammers to counter the SAM threat.

(c) With the exception of the type and number of jammers, the EA-3B performance and PECM configuration is basically the same as the EB-66C. Therefore, approximately the same orbit extension is required to obtain location accuracies of 5-15 nm, providing the signal remains up for 6 to 10 minutes.

(3) Both equipments have provided good protection to the strike forces. QRC-160-1/ALQ-71 resources in Southeast Asia do not permit installation in all Air Force strike aircraft. In addition, to accomplish the much needed installation of the ALQ-51 in the F-4B, aircraft provisions, beyond those currently in effect, must be made to set up modification lines. This may require a temporary reduction in F-4B aircraft available for combat assignment.

(4) The possibility always exists that either C-band or X-band SAM systems, or both, could be deployed to North Vietnam and could include IR homing. Deployed active ECM systems are capable of countering only S-band SAM and AAA radars. New antennas are needed, with a unique type of polarization, IR detectors, and IR countermeasures. An urgent requirement exists to expedite the following programs in order to properly protect US forces as further advanced enemy tactics and technologies emerge:

(a) The QRC-160-8 pod (S and C-band): to provide higher power (300 watts in the pulsed noise mode) and wider frequency coverage.

(b) The ALQ-81/100 (S and C-band): which will provide deception jamming.

(c) The QRC-335: a deception repeater and fuze jammer, to counter SAM and AAA radars and missile fuzing.

(d) The QRC-314: a missile fuze jammer to predetonate the GUIDELINE fuze (this jammer is presently in the test phase of development).

(e) A development effort now underway to modify present X-band pod equipment to counter the X-band SA-3 radar.

s. Active Electronic Countermeasures

(1) Stand-off active ECM support provides protection of the strike force; using either modulated noise, as in the case of the EB-66B (23 jammers

(6) Tactical ELINT/COMINT collection in the NVN defense environment is not timely, accurate, or adequately representative of the actual qualitative or quantitative NVN radar posture. Thus perishable SIGINT data is not available to tactical commanders for daily operational planning and/or to crews for daily pre-mission briefing and formulation of a meaningful enemy order of battle.

(7) With approval of funding and authorization to expedite existing programs, a major improvement in PECM systems can be made. A capability for real time transmission of emitter location and type can be incorporated in PECM/ELINT/COMINT aircraft of both Services. Direction finding techniques, such as interferometer and phase comparison and high rate of signal recognition will permit tactical forces to handle typical air defense environments. Superheterodyne digital tuned receivers, pulse deinterleaving networks and PRF discriminators/counters, will enhance the accuracy of signal analysis. Follow-on programs must include the acquisition of sufficient passive ECM platforms to provide adequate sorties for complete geographical coverage of the ground radar environment and effective support of tactical strike forces, around the clock. The incorporation of accurate and world-wide LORAN D and TOA will provide the degree of navigation accuracy required for resolving radar locations within 500 feet.

r. Self-Protection

(1) QRC-160(A)-1/ALQ-71 consist of 4-75 watt voltage tuned magnetrons housed in a pod configuration. This equipment, which incorporates modulated noise jamming techniques, operates in S-band against the AAA and SAM radars. The QRC-160-2 pods are also employed in limited numbers to counter the X-band air intercept threat.

(2) The ALQ-51 is an internally mounted deception repeater. The deception techniques employed, provide protection for single aircraft against S-band counter-air missile and fire control radars.

jettison of stores, and Russian technical intelligence available to North Vietnam, the following electronic warfare equipments are presumed to have been compromised:

- (1) RHAW APR-23/24/25/26 and AP3-54
- (2) Passive Receivers APR-9/14, ALQ-61, and ER-133
- (3) Active Transmitters ALT-6B/13/15/16, ALQ-51, QRC-160

This information emphasizes the need for self-destruct systems in all future electronic warfare equipments and those not yet deployed or operating over hostile territory.

B. (TS) TACTICS

1. General

a. Since the beginning of US air operations over North Vietnam, US air tactics have been evaluated and modified to achieve what, in the light of experience and available data, appeared to afford best strike effectiveness and least aircraft/aircrew attrition. For example, in the beginning reliance was placed upon low level rocket and strafing attacks for flak suppression and destruction of soft targets. Multiple passes at the target were often made. To reduce the loss rates experienced when operating at low levels within the lethal range of light AAA and automatic weapons, strike forces raised minimum operating altitudes and limited the number of attack runs on targets.

b. As the MIG threat increased, MIG CAP and escort of strike forces became necessary. Also, the introduction of the SAM missile created a requirement for the installation of radar homing and warning (RHAW) equipment in strike aircraft for SAM warning; the organization of IRON HAND operations to attack SAM sites; and the restriction of operations within SAM defended areas to VFR conditions. With the introduction of the QRC-160 noise jammer and the ALQ-51

~~SECRET~~

per aircraft), or deception/noise jamming by the EA-6A. The EA-1F and EF-10B are configured with noise jammers also. Each of these aircraft has a capability to counter radars operating in P, S, and X-band and also dispense chaff.

(2) Insufficient numbers of EB-66B aircraft preclude releasing the EB-66C for tactical passive ECM collection in the target area. The EB-66B is not currently configured for in-flight changing of jammer frequencies in the event the ground radar defenses intentionally or unintentionally shift operating frequency. The EA-1F and EF-10B are restricted to providing ECM support within route packages where ground environment is compatible with the aircrafts' limited ECM capability. Limited resources of ECM equipments and the absence of manual or electronic control of directional antennas limit active ECM effectiveness. In the event the C-band SA-2 or the X-band SAM 3 system is introduced in North Vietnam, the major US limitation would be the availability of C and X-band active ECM equipments.

(3) The number of NVN radars has grown over the past three years to the point that US resources of active ECM equipment and stand-off ECM aircraft are incapable of screening a large strike force in Route Package VI. The present method of look-through in the EB-66C prevents extended periods of surveying the spectrum for holes in jamming or obtaining bearings for accurate radar location. A development effort is now underway to provide a stand-off jammer operating in S and C-bands, which will produce about 30 kilowatts/MHz of jamming power to counter the S-band SA-2 systems. This would adequately screen a strike force in a rectangular area 80 by 30 nautical miles. An advanced tactical electronic warfare system (ATEWS), now under study, will be composed of jammers and passive receivers will counter the entire radar threat spectrum from early warning to terminal guidance radars.

t. Compromise of Electronic Warfare Systems. Based on actual shoot-downs, crews captured, inadvertent

~~SECRET~~

d. Munitions Availability and Effectiveness. Efforts to neutralize the enemy air defense system have been handicapped because the munitions which are most effective in destroying AAA, automatic weapons, SA-2 battalions, and radars are scarce and because we have had difficulty in accurately locating these defenses. The density of automatic weapons and light AAA dictates weapons delivery methods which permit release and recovery above the effective range of these weapons. Operating techniques and the use of ECM, RHAW, and IRON HAND support have allowed the strike force to operate in high threat areas with minimal losses from missiles. (See Appendix H.)

e. Constraints. Some tactics have been shaped by restrictions against attacking MIGs on airfields, striking military installations in populated areas, and flying in the Chinese buffer zone. CAP has been increased to cope with the MIG threat. Restrictions against attacking targets in populated areas has resulted in by-passing some key elements of the NVN air defense and LOC systems (POL storage, port facilities, SAM support facilities, command and control centers, bridges, etc.). In essence these restraints have diluted the effectiveness of US tactical air power and have tended to channel US air operations into general patterns which the enemy can more easily anticipate.

3. Current Tactics--Related to Defenses and Mission. The following is a general discussion of tactics now employed by USN/USAF aircraft, categorized by mission and related to how each is affected by the NVN Air Defense System:

a. Lightly Defended Targets Outside of Missile Envelope. When striking lightly defended targets, penetrations are normally at best cruise altitude (above 15,000'). When over these targets, bombing, rocket, and strafing runs may be carried to low release and firing altitudes (below 4500') to improve delivery accuracy. Multiple runs can be made.

b. Heavily Defended Targets Outside of Missile Envelope. Tactics employed against heavily defended targets have been more restrictive. Weapons delivery is limited primarily to steep dives (40° - 60°) with a release altitude that permits the aircraft to bottom out above the most effective range of automatic weapons and light AAA. Normally, only one pass is made.

deception repeater, operating altitudes within SAM areas have been raised.

c. Other contributions to changes in tactics have been made through the introduction of the A-6A aircraft and the MSQ-77 ground radar control system for night and all-weather operations.

d. There are no significant differences in the basic tactical concepts of units of the 7th FLT and 7th AF. Most of the differences which exist are those of basing, and routes and distances to targets.

2. Factors Shaping Tactical Operations. The continuing evolution of the enemy air defense system has been the primary factor in determining US air tactics. However, the following factors, some within our control, also have been important in shaping tactical operations:

a. Capabilities of US Tactical and Support Forces. With the exception of shortcomings in night and all-weather capabilities, US tactical aircraft and crews have been capable of completing assigned tasks. Though not the only degrading factor, the gradual build-up of forces prevented the use of sufficient mass to overwhelm enemy air defenses at the outset, coincidental with the destruction of assigned targets.

b. Electronic Countermeasures. The limited availability of ECM support aircraft and ECM equipment for strike aircraft has restricted operations in the high threat areas. The masking provided by mountainous terrain in some areas of North Vietnam has limited the effectiveness of ECM.

c. Weather Minimums. The combination of SAMs, AAA, automatic weapons and MIGs has caused the establishment of minimum weather requirements of ten thousand feet ceiling and five miles visibility in SAM defended areas over North Vietnam.

Fighter escort is provided for support aircraft (ECM, ELINT, and recce) as required. Visual identification is required before opening fire, therefore, tactics have been of the day visual fighter type. Although the MIG kill ratio has been favorable and the MIGs have been a relatively minor threat to date, they have been responsible for complicating the problems created by enemy air defenses; by the requirement for support and CAP/escort aircraft, and by causing mission aborts (ordnance jettisoning) by US aircraft prior to reaching targets.

g. Armed Reconnaissance. The majority of attack sorties flown over North Vietnam have been armed reconnaissance:

(1) Armed reconnaissance missions are flown at altitudes between 3000 and 5000 feet above ground level, during daylight hours; as the best compromise between an acceptable degree of protection against automatic weapons and light AAA, and acceptable visual target acquisition. In heavily defended areas, single-pass attacks using varied run-in headings are employed. In lightly defended areas, multiple passes may be made to increase the probability of target destruction.

(2) Night armed reconnaissance attacks are conducted primarily by A-4, F-4, and A-6 aircraft. For effective attack, the A-4 and F-4 require visual acquisition and flare illumination of targets. The A-6 is an all-weather weapons system which does not require visual reference to targets which present a good radar return.

(3) Efforts have been made to improve the effectiveness of the night armed recce program by introducing the acquisition/control/attack concept. Either an Army Mohawk, equipped with Moving Target Indicator (MTI) side looking radar or a Navy RA-3B equipped with infrared sensors is used for initial target acquisition.

c. Targets Within Missile Envelope. Tactics for those targets which are within the SAM envelope are essentially the same as for heavily defended targets. The majority of units penetrate above 9,000' in order to remain above the effective range of automatic weapons and light AAA. More support aircraft are required for strikes penetrating the missile envelope, especially those attacking targets located north of the 20th parallel where MIGs are located. These additional aircraft are utilized for flak suppression, electronic warfare, escort, CAP, IRON HAND, and search and rescue (SAR) support.

d. Flak Suppression. In the early months of the war flak suppression was a costly venture in terms of results achieved. For this reason it was reduced to a minimum. With the advent of CBU-24 and large VT-fuzed low drag bombs, employment of flak suppressors increased. These weapons provide good area coverage and permit higher weapon release altitudes. Some aircrews interviewed stated that since flak suppression has increased AAA gunners appear to be less aggressive.

e. Anti-SAM (IRON HAND) Tactics. Current anti-SAM tactics employ the SHRIKE missile system in aircraft which precede or accompany strike aircraft to the target area. When a SAM radar is detected by RHAW equipment, the pilot flies a course toward the radar until it is acquired visually or on the SHRIKE missile system. Tactics vary, depending on the location of the target, enroute and target terrain, density of radar activity, operational activity and techniques of the target radar, and SAM evasion actions required. SAM mobility, camouflage, and emission control techniques make it a difficult system to attack. The inability to accurately measure the range to enemy radars causes some out-of-range SHRIKE firings.

f. Anti-MIG Tactics. The force which provides counter-air consists primarily of Air Force F-4C and Navy F-4B/F-8 aircraft. The fighters perform close escort or are positioned between the known or suspected enemy threat and friendly air operations.

(3) Due to their limited maneuverability, which precludes optimum SAM evasion tactics, all tactical ECM aircraft except the Marine EA-6A stay outside of known missile envelopes when possible.

(4) There is a valid requirement for tactical aircraft to possess defensive ECM capabilities adequate to counter the enemy electronic defense environment; particularly SAM and AAA radars. For this purpose, 7th FLT attack and reconnaissance aircraft employ the ALQ-51 deception repeater and 7th AF tactical aircraft use QRC-160 noise jammers. Additionally, Marine EA-6A aircraft can be employed in formation with strike aircraft to provide close-in tactical jamming.

j. Search and Rescue

(1) The Commander 7th AF is responsible for SAR coordination in the Southeast Asia area of operations and exercises operational control of all US Air Force SAR forces. CTF-77 exercises operational control of US Navy SAR forces. (See Appendix G.)

(2) US Navy SAR forces are comprised primarily of UH-2A/B and SH-3 helos, A-1 RESCAP and two DD/DLGs located at northern and southern SAR stations. Navy rescue operations are conducted mainly in the Tonkin Gulf and coastal areas of North Vietnam.

(3) US Air Force SAR forces are comprised of HH-3E and HH-43B/F helos, UH/SA-16, HC-130P, and A-1 RESCAP aircraft. US Air Force SAR operations are conducted over all land areas, plus HU-16 support in the Tonkin Gulf.

(4) Navy Operating Procedures

(a) One UH-2A/B helo is embarked in each SAR DD/DLG. These helicopters are armed, equipped with self-sealing fuel cells and armor plate and are on alert status 24 hours a day.

h. Tactical Reconnaissance. No significant differences exist in the basic concept of tactics by the tactical reconnaissance forces of the 7th FLT and 7th AF. Specific differences which do exist are due to approaches from land versus sea bases, terrain, weather encountered, and varying sensor capabilities. It is 7th FLT policy that tactical reconnaissance aircraft be escorted. The escort, normally a single fighter, is for Search and Rescue (SAR) assistance and warning against AAA threats. Under existing 7th AF policy, tactical reconnaissance missions in lightly defended areas are flown by single aircraft and escort is provided only when warranted by target defenses and/or MIG threat.

i. Electronic Warfare. There are no significant differences in the basic service concepts for requirements and utilization of electronic warfare support forces for either passive ECM or active ECM. Several types of aircraft are employed, with variations in ECM capabilities.

(1) The active ECM aircraft (EB-66, EF-10, EA-6A, and EA-1F) provide stand-off jamming in support of attack/reconnaissance forces. The basic tactic is to fly an orbit/pattern along the flight path of the strike forces, forcing enemy defense radars to look into the active ECM aircraft's jamming pattern to acquire targets. The EA-6A can provide stand-off jamming or accompany strike aircraft on the mission.

(2) The Navy and Air Force are provided passive ECM support by EC-121 type (BIG LOOK) aircraft on station over the Gulf of Tonkin. These aircraft provide SAM and MIG alerts to tactical aircraft. Passive ECM aircraft (EB-66C, EA-3B, EA-6A, and EF-10B) are configured to perform electronic reconnaissance and surveillance missions over prescribed routes for the purpose of monitoring and updating the electronic order of battle.

(2) SAR operations have been degraded by the following equipment and environmental factors:

(a) The limited range and endurance of present rescue vehicles (HH-3/SH-3) restricts the area which can be covered.

(b) The slow speed of the rescue helicopters results in excessive reaction time from notification to pickup, reducing probability of recovery.

(c) Available helos are vulnerable to enemy groundfire due to the low altitude and slow speed inherent in SAR operations. The requirement to hover for pickup increases the hazard.

(d) Night recovery capability is limited due to difficulty in:

1. low level navigation and terrain avoidance; and

2. locating downed airmen during hours of darkness.

(9) Future SAR operations will be enhanced through better self-protection, extended range, and higher speed for the helicopter. Three M-60 miniguns are being installed in all HH-3Es. The HH-53B, with 50 knot higher airspeed and self-protection armament will be added to the inventory in early FY 68. Both HH-3Es and HH-53Bs will be capable of air refueling from the HC-130P.

(10) Development programs are underway to adapt Low Light Level Television and/or Forward Looking Infrared sensors to rescue vehicles to improve the night rescue capability.

4. Effect of Tactics on Attrition

a. In reviewing US tactics against the NVN Air Defense System, an analysis of US aircraft losses was made. To select some common base for analytic

(b) Embarked on one of the three YANKEE STATION CVAs is a three plane SH-3A helicopter detachment. The SH-3A is armed, equipped with self-sealing tanks and armor plate, and is the primary Navy rescue vehicle used over North Vietnam. One SH-3A is airborne at all times during daylight hours; escorted by A-1 RESCAP. During the hours of darkness, both the SH-3A and A-1s are held in a ready alert status aboard the CVA.

(5) Air Force Operating Procedures. SAR support aircraft are normally airborne whenever air operations are being conducted over North Vietnam. Pre-designated orbit areas are established for the HC-130Ps and HU-16s over Laos and the Gulf of Tonkin; these areas being dictated by target location. The HH-3Es normally stage into advanced operating bases in Laos and are committed to five minute ground alert or to airborne alert in permissive areas. In addition to the normal rescue vehicles, RESCAP aircraft (A-1Es) are placed on alert status at Udorn.

(6) When an aircraft is shot down, the initial SAR effort is normally accomplished by the accompanying strike/CAP aircraft. This consists of locating the downed airman and directing SAR forces to the rescue area. Upon notification, SAR alert forces are scrambled, if not already airborne, and directed to the rescue area.

(7) The success of the rescue effort is dependent, to a large degree, on the intensity of enemy defenses and the proximity to population centers. Although RESCAP and escort aircraft carrying ordnance are usually available to suppress groundfire, the size and slow speed of rescue aircraft, along with the inherent requirement for low and slow flight, make the rescue aircraft vulnerable to enemy fire. Rescue efforts are virtually prohibited in the heavily defended and densely populated areas of Route Package VI.

d. The Navy has had most of its aircraft equipped with ALQ-51 throughout the periods compared, but has not yet commenced use of CBU-24. Navy losses have been relatively low throughout the period and have decreased somewhat but not significantly--whereas Air Force over-all losses, which were relatively high, have decreased very significantly. Target selection, tactics, and weather are recognized as influencing factors. Taking all this into consideration, the Air Force drop in attrition is noteworthy. Navy attrition has been:

NAVY LOSSES PER THOUSAND ATTACK SORTIES

<u>Route Package</u>	<u>Apr-Sep 66</u>	<u>Oct-Feb 67</u>	<u>Change Factor</u>	<u>Confidence Level</u>
II - III	2.3	1.5	Down 1.5	75%
IV	1.7	3.9	Up 2.3	92%
VI	3.8	3.6	No change	N/A

5. Tactics for FY 68/FY 69 and Subsequent. New or improved equipments expected during FY 68 and subsequent are designed to provide better self-protection against radar directed defenses; greater stand-off capability against certain targets; better accuracy in locating S-band emitters; more effective radar/communications jamming; and increased quantities of more effective munitions. New tactics, related to the employment of these improved capabilities against the SAM/AAA/MIG environment, will evolve as follows:

a. Tactics Against the EW/GCI Systems. The NVN Early Warning (EW) and Ground Controlled Intercept (GCI) net provides the enemy with radar warning and the means of effectively controlling interceptors in a defense environment including heavy AAA and SAMs. Loss of the radar network would significantly impair enemy air defense operations. The technical limitation to US capability to destroy radars is the problem of detection and location. Time of Arrival (TOA) equipment will significantly improve the problem of transmitter location, at least against S-band radars. The variety of EW/GCI radars and their

effort, an attempt was made to determine the attrition trade-offs involved in various methods of countering the NVN Air Defense System. (Such analyses are included at Appendix H.)

b. Recent attrition experience implies that a significant advantage over the enemy may have been attained primarily by the tactical exploitation of new electronic warfare equipments and munitions. For Air Force attack sorties, the attrition reduction has been as follows:

AIR FORCE LOSSES PER THOUSAND SORTIES

<u>Route Package</u>	<u>Apr-Sep 66</u>	<u>Oct-Feb 67</u>	<u>Reduction Factor</u>	<u>Confidence Level</u>
VI	25.8	7.8	3.5	99.9%
V	7.2	1.8	3.9	98 %

The reduction in Air Force attrition in Route Package VI correlates with higher release altitudes, increased use of ECM and an increase in the use of CBU-24 for flak suppression. The following data summarizes CBU-24 expenditures:

CBU-24 EXPENDITURES

- Jul-Sep 66 - 693/3 = 231 per month average
- Oct-Jan 67 - 1739/4 = 435 per month average

c. With employment of the QRC-160 pod, the Air Force has been able to fly at higher enroute altitudes (thus avoiding AAA) which has resulted in a slightly decreased enroute attrition rate. There has been no increase in attrition to SAMs and no increase in SAM effectiveness-per-engagement, despite flying at altitudes more favorable to SAMs. This implies that the QRC-160 has been effective in countering SAMs.

~~SECRET~~

d. Tactics Against the SAM. Loss of tracking information from the GCI net would probably deny the SAM system its emission control (EMCON) capability and require that the acquisition radar be utilized to a greater extent; and thus become more vulnerable. EW/GCI sites and SAM radars which are located by Compass Strike/EELS can be destroyed by the Compass Strike aircraft (F-4D) or by accompanying strike aircraft with SHRIKE/Standard ARM or rockets and free-fall bombs. Once the sites are located, follow-on attacks may be made by vectoring strike aircraft to the targets with ground radar control (MSQ-77) or airborne control radar (E-2A). The airborne effort will be augmented by the TALOS ARM system.

e. Tactics Against the AAA. Compass Strike/EELS directed attacks, coupled with flak suppression improvements associated with more accurately delivered weapons, will form the basis of the new anti-AAA tactics. The purpose will be to deny acquisition and tracking information to radar directed guns, thus rendering them far less efficient.

C. (S) COORDINATION AND CONTROL

1. General

a. CINCPAC, as the commander of all US forces in the Pacific area, exercises command and control of US air operations in North Vietnam through CINCPACFLT and CINCPACAF as Service component commanders, and COMUSMACV as a subordinate unified commander. In order to define the areas of responsibility, CINCPAC has subdivided North Vietnam into seven operating areas called Route Packages (RP). These packages are numbered I through V and VIA and VIB. (See Chart at TAB C to Appendix B.)

b. Responsibility for coordination of air operations in Route Package I is assigned to COMUSMACV; in Route Packages II, III, IV, and VIB to CINCPACFLT; and in Route Packages V and VIA to CINCPACAF. CINCPACAF has further delegated his authority to the Commander, 7th AF. Consequently, the Commander, 7th AF, as a subordinate commander to CINCPACAF and the Air Force component commander to COMUSMACV, exercises coordinating authority for operations in Route Packages I, V, and VIA.

~~SECRET~~

~~SECRET~~

dispersion complicate an all-out attack against them until a multi-frequency TOA capability exists.

b. Interdiction of Lines of Communication. Some of the weapons and weapon systems that may increase US air interdiction effectiveness beyond FY 68 are the A-7 and F-111A aircraft, the MSQ-77, and aerial-delivered mines. Employment of the F-111A in CY 69 and installation of the MSQ-77 in northern Laos, when used in conjunction with active ECM, will enhance US all-weather strike and interdiction capability in North Vietnam. Aerial-delivered anti-vehicle land mines will enhance the means of restricting enemy logistic movements without the attendant attrition associated with the interdiction of bridges and other heavily defended LOC links.

c. Tactics Against the MIG. The introduction of new US equipments and improved coordination/control procedures should increase US tactical superiority over the NVN MIG force. Anti-SAM ECM equipment will allow CAP aircraft to operate effectively at altitudes above most conventional AAA weapons; and AIM-4 (F-4D) and AIM-7F (F-4J) air-to-air missiles will improve US effectiveness in air-to-air engagements. The F-4E, with its internally mounted gun, will also enhance future air-to-air effectiveness. Air-to-air identification systems (TEASER/TRISAT) will afford positive identification of enemy aircraft and allow a change in Rules of Engagement to permit firing without visual identification. The most promising means of improving the MIG kill ratio stems from the fusion of all available intelligence data and introduction of these data in real-time form into a coordinated information network. The level of success of future air-to-air operations will depend upon the degree to which the critical elements (aircraft and weapon capability, current intelligence, positive control and coordination, flexibility of operations, and security) can be combined.

~~SECRET~~

~~SECRET~~

4. Marine Corps Procedures. Current Marine air operations in Southeast Asia are conducted primarily in support of III Marine Amphibious Force (III MAF) ground operations in South Vietnam. The Commanding General, III MAF also makes available to COMUSMACV those Marine air assets not required to support III MAF ground operations. Such forces are included in the 7th AF daily frag order for Route Package I. By special agreement, certain Marine air assets, such as EW, ECM and tanker aircraft, are also provided for the support of 7th AF and/or CTF-77 operations in North Vietnam. When Marine air units operate in support of other than Marine ground forces they operate according to current 7th AF or TF-77 procedures; depending upon the type of support provided. As a result of an agreement between the Commanding General, 1st MAF and the Commander, 7th AF, targets in Route Package I, near the DMZ, which may directly affect ground actions in that area, are authorized for attack by Marine air units on short notice, without prior scheduling, provided that the 7th AF Command Post is notified prior to mission execution.

5. Control Procedures

a. Control procedures for US air operations in North Vietnam are almost identical for all of the participating Services. These procedures consist of target selection by operations and/or intelligence personnel; assignment of a target or target area, (i.e., recce) to a particular crew or crews; a pre-mission brief on the target or target area, including available intelligence; and the crew(s) performing the mission as briefed. MIG, SAM and CHICOM border warnings are provided to mission aircraft. Strike aircraft can be diverted, after launch, to an alternate target area in the event target change is desired.

b. Fusion of Intelligence

(1) The ability to exercise control of US aircraft over North Vietnam depends on the fusion of various sorts of information. Information derived from air and surface radars, combined with special intelligence, when correlated with

~~SECRET~~

~~SECRET~~

c. Coordinating authority for those areas assigned to CINCPACFLT has been further delegated to CTF-77 through the Commander, 7th FLT.

d. Coordination and control of all US air operations in North Vietnam is effected through a joint agreement between the Commander, 7th AF and CTF-77. Continuing coordination and improvement in procedures is achieved through a joint 7th AF and TF-77 coordinating committee which meets monthly or as necessary.

e. Coordination of Marine Corps air operations in North Vietnam is effected through a joint agreement between the Commander, 7th AF and the Commanding General, First Marine Aircraft Wing (1st MAW).

2. Navy Procedures. The targeting concept for interdiction in the Navy areas of responsibility is developed and promulgated by CTF-77. Route Packages II, III, and IV have been subdivided further into six East-West sectors. Each of the three attack carriers at YANKEE STATION is assigned two of these sectors, one to the north and one to the south. Each Carrier Task Group Commander is responsible for the conduct of operations in his assigned sectors. He selects his interdiction targets based on the over-all targeting concept established by CTF-77 and issues a daily air plan for his carrier, assigning primary and secondary/divert targets to individual crews.

3. Air Force Procedures. All control of US Air Force flight operations in North Vietnam is centralized in the Commander, 7th AF at Tan Son Nhut Air Base, Saigon. A detailed 7th AF frag order is issued daily assigning aircraft to targets, specifying routes, time over target, tanker rendezvous, and ordnance. Primary, secondary, and, sometimes, tertiary targets are assigned. Final target assignments and execute orders are directed by the 7th AF Command Post, Saigon. Provision is made for flight leaders to divert to alternate assigned targets in the event the flights are unable to strike assigned targets. Frag orders are transmitted by secure teletype to all operating units at bases in South Vietnam and Thailand. Changes to the frag orders are transmitted by teletype or, if time does not permit, by telephone.

~~SECRET~~

III-33

~~SECRET~~

(5) The Tactical Data Communications Center of the MTDS is the place at which the interface between BUIC II and MTDS/NTDS will be accomplished. There are significant decisions that remain to be made in order to develop the automated data interface. Not the least of these decisions is program specification. A draft plan prepared for the US Air Force by MITRE Corporation is now in circulation among the Services and NSA for concurrence. When a plan has been agreed upon, the following must be accomplished: statement of work, development of specifications for equipment interface, software and over-all test; system test, integration and check out planning; and, award of contracts as necessary.

(6) Project IRONHORSE is scheduled to provide digitized data by September 1967. If MTDS is in place near Monkey Mountain at that time, such data can be accepted by MTDS and NTDS. Meeting the scheduled completion date of second quarter FY 68 for interface of BUIC II with the rest of the system will require taking full advantage of previous experiences in the field, as well as a fully integrated effort by all agencies concerned.

(7) It should be re-emphasized that the netted semi-automated data systems will provide only a more rapid means for the fusion and display of intelligence and operations data to the operational commanders. In itself, the system does not add to sensor or routine communications capability.

c. Communications

(1) The communications equipments and nets employed in coordination and control of US air operations are radio voice or teletype channels in the HF and UHF frequency bands. Compatible equipment links are operative between all US elements in the area. The combat areas in North Vietnam are normally beyond direct UHF range. Therefore, UHF communications require the use of radio relay aircraft or MIDDLEMAN. Air Force relay aircraft now retransmit on only two channels, one of which is Guard Channel. By the end of FY 67,

~~SECRET~~

known US flight routes, permits moderately accurate flight following of US flights in North Vietnam and often provides positive identification of enemy aircraft. The key element of the current capability is special intelligence.

(2) Since special intelligence is sensitive and perishable there have been problems in using such intelligence in a timely manner. At present, the steps in the exchange of special intelligence are performed manually and the process is relatively slow. Therefore, emphasis is placed on distribution of that information required for the defense of US forces.

(3) The fusion of all elements of intelligence has a significant impact on both defensive and offensive US air operations in North Vietnam. Excellent results are being obtained by the use of this data in tactical defense. However, there is a potential use for this data for offensive purposes which has not been realized to date.

(4) IRONHORSE is a project to provide digitized data derived from special intelligence sources for use in semi-automatic data systems. It is scheduled to be installed at Danang, and to be operational in September 1967. The Navy Tactical Data System (NTDS) will be able to use the digitized data provided by IRONHORSE when the Marine Tactical Data System (MTDS) installation on Monkey Mountain (Hill 647), Danang, is completed. NTDS/MTDS are compatible systems. The Tactical Data Control Center (TDCC) of the MTDS will accept the data from IRONHORSE and relay it for display throughout the NTDS/MTDS systems in the area. Additionally, the US Air Force is installing a semi-automatic data system on Monkey Mountain and at Udorn, Thailand. The Air Force will initially utilize IRONHORSE data through manual inputs. To achieve maximum correlation of the IRONHORSE data and other intelligence and operational data, it is necessary that the semi-automatic systems be netted into one compatible system. The candidate systems to be netted are BUIC II and NTDS/MTDS with IRONHORSE data injected. If the candidate systems are to be netted, development of an automated data interface between BUIC II and NTDS/MTDS will need to be accomplished.

~~SECRET~~

PART IV - DISCUSSION

A. (S) GENERAL. The purpose of this discussion is to develop the courses of action which are open to the United States in air operations over North Vietnam. It will first address the major factors that have dictated the manner in which US air operations have been conducted. Second, it will outline, by functional area, other factors related to US air operations. Finally, it will discuss alternative courses of action for obtaining US military objectives in North Vietnam.

B. (S) FACTORS LEADING TO THE PRESENT SITUATION

1. US Objectives, Policy, and Major Operational Factors

a. The objective of the US air campaign in North Vietnam has been to apply steadily increasing pressure in order to cause Hanoi to cease its aggression in South Vietnam, and to make continued support of the Viet Cong insurgency as difficult and costly as possible.

b. Since the start of ROLLING THUNDER operations in March 1965, the application of air effort against North Vietnam has been guided by a policy of gradually increasing pressure. (A digest of concepts and recommendations of the Joint Chiefs of Staff regarding air operations in North Vietnam is included in Appendix C.) During this period the United States doubled its tactical air forces in the area. During the same period North Vietnam air defense forces more than quadrupled.

c. In CY 66 US tactical air forces flew 106,461 sorties and dropped 129,496 tons of bombs in North Vietnam. Approximately 80 percent of these sorties were in armed reconnaissance flights along roads, railroads, fords, bridges and trails in the countryside. These attacks have forced North Vietnam to divert about 300,000 personnel into additional logistic efforts and passive air defense measures and have significantly impeded the movement of men and material into South Vietnam. However, this effort has not been sufficient to cause North Vietnam to stop its aggression in South Vietnam. Further the pace of US attacks has not

~~SECRET~~

~~SECRET~~

this capability will be doubled to four channels. Navy MIDDLEMAN aircraft relay a single UHF frequency.

(2) Increasing use is being made of secure channels for voice and teletype. The KY-28, a secure voice equipment small enough for use in tactical aircraft, has been developed and installation in tactical aircraft will be accomplished during FY 68. KY-8 equipment currently installed in the larger support aircraft (BIG LOOK, BIG EYE, COMMANDO LANCE) now provides a limited exchange of information, on a secure basis, with ground/sea control agencies, e.g. MOTEL and PIRAZ.

~~SECRET~~

III-37

statistically significant drop in US aircraft losses. However, since the technological base of North Vietnam extends to the Soviet Union, it must be anticipated that current US innovations will be countered and the recent favorable trend may be only temporary.

C. (S) OTHER FACTORS RELATED TO US AIR OPERATIONS IN NORTH VIETNAM

1. US Intelligence

a. Although many components of the NVN Air Defense System have been located and identified in suitable detail to allow analysis and targeting, there are still some gaps in the intelligence that is available. The majority of radars detected have not been correlated with photography and targeting information is lacking on certain intermediate filter centers in the early warning network. The mobility of radar, AAA and SAMs has further complicated the problem.

b. Very little is known precisely concerning details of importation of war material. US intelligence sources have been unable to establish the relative proportion of war materials brought in by land or sea; however, they have determined that all North Vietnamese weapons and munitions are imported. It is estimated that 220,000 tons of air defense munitions were used in 1966.

2. US Tactics

a. The tactics employed by US air forces have constantly changed in response to enemy actions and improvements in US equipment and knowledge. The growth and effectiveness of enemy antiaircraft weapons have required abandonment of some tactics and weapons. Enemy fighter aircraft have also forced changes in tactics that result in less efficient use of strike aircraft.

b. There are no significant differences in the tactics of the Navy and Air Force other than those occasioned by different base locations and some minor differences required in exploiting features of dissimilar electronic warfare equipments. A detailed discussion of tactics is included at Appendix F.

prevented North Vietnam from importing and putting together a formidable air defense system, constructing multiple lines of communication and creating a veritable warehouse of vital military supplies throughout the North Vietnam panhandle.

2. NVN Objectives, Policy and Air Defense Forces

a. Prevention of effective US air operations over North Vietnam is an obvious major objective of North Vietnam. In pursuit of this objective North Vietnam has improved its air defenses by continual imports of Russian and Communist Chinese weapons. To a degree they have maintained their freedom to do so by propaganda and political pressures on the United States.

b. The fact that the North Vietnam Air Defense System is totally dependent on outside sources of supply is its greatest weakness. The continued access of the enemy to outside weapons and munitions is not dependent upon his military capabilities, but rather upon the sufferance of the United States. As long as this situation continues, the enemy will retain an effective source of new weapons and resupply. Conversely, if it is decided to deny him access to outside weapons and munitions, US tactical air forces presently in Southeast Asia can reduce support to the point that the enemy air defense is neutralized.

c. The North Vietnam Air Defense System has been a dynamic and constantly growing organization. From March 1965 to March 1967 the growth in guns (1400 to 6100), radar (50 to 450) and jet fighters (30 to 112) has been impressive. With open ports and railroads, the growth of the NVN Air Defense System has been limited only by training and the type and amount of weapons its allies have made available.

d. Technical achievements have been noteworthy. They have included the first combat use of surface-to-air missiles; introduction of modern fighter aircraft; use of radar-directed guns; and radar emission control.

e. A combination of tactics, munitions and electronic warfare equipment has permitted satisfactory counteraction by US tactical aviation. This has resulted in a recent

b. The growing intensity of enemy air defenses and the requirement for weapon delivery accuracy interact to require new conventional weapons capable of being delivered with high accuracy from outside the envelope of target defenses. Improved interdiction weapons, designed to increase or prolong the damaging effects of attacks on bridges, roads, railroads, and waterways are also required. Stocks of the most effective munitions have not been available in sufficient quantities to permit tactical exploitation or to accommodate changes in enemy defenses and tactics. A detailed discussion of weapons and munitions is included at Appendix E.

5. Effect of Weather on US Air Operations

a. During the northeast monsoon--from November until the latter part of March--weather conditions in the Hanoi and Haiphong areas are poor. Throughout this period, enemy air defenses, weather and LACK OF SUFFICIENT ALL WEATHER STRIKE AIRCRAFT have combined to reduce air operations markedly in the heavily defended route packages.

b. The northeast monsoon and the shortage of all weather attack systems have caused reduced scheduling; ineffective interdiction of LOCs, increased weather cancellations; and increased diversions from primary targets to targets of lesser importance in North Vietnam or to targets in Laos or South Vietnam.

6. Coordination and Control of US Air Operations

a. The coordination and control procedures in existence between 7th AF and TF77 have evolved during the course of the war and are fully adequate to support current and projected operations. A practical degree of control and advisory service to US aircraft operating over the Gulf of Tonkin and North Vietnam has been achieved. The use of separate geographic areas of primary responsibility affords a measure of pilot familiarity with terrain, targets, weather and antiaircraft order of battle that would otherwise be unobtainable. This familiarity has contributed to effectiveness and reduced attrition. Procedures are in effect to

c. It is possible that at some future point, analysis will indicate that an air campaign against the NVN Air Defense System, or against some segment of it, would be logical. This might occur if US loss rates climb while at the same time improved weapons systems permit effective suppression of enemy air defenses in an anti-air campaign. It has been established that these conditions do not exist now. With unlimited enemy resupply, it is unlikely that there could ever be a point where analysis will show that an anti-air campaign would be sound, tactically or economically.

3. US Aircraft Attrition. US aircraft loss rates have declined during the past eight months. This is apparently due to the use of improved US electronic warfare equipments, flak suppression munitions, and tactics. The monthly loss rate in North Vietnam has decreased from a high of .27 percent per sortie in July 1966 to .07 percent per sortie in February 1967. A more significant indicator is the decline of losses in the intensively defended area of Route Package VI, from a rate of 1.65 percent per sortie in July 1966 to a low of .30 in February 1967. The reasons for the decline in attrition rate of recent months cannot be accurately defined and the extent to which the decline will continue is unknown. For planning it should be assumed that the downward trend in attrition is temporary. If the enemy employs weapons such as heat-seeking missiles, improved SAM systems, AAA with proximity fuzes, or more effective ECCM, attrition will increase. A detailed analysis of aircraft losses is included at Appendix H.

4. US Air Munitions

a. On the whole, the United States has had adequate gross tonnages of air munitions in the field. However, there have been deficiencies in the amounts of most effective weapons for specific tasks. This has resulted in some forced substitution. The optimum tonnage of munitions in Southeast Asia has been set at 135,000 tons. On 1 March 1967, some 210,000 tons were on the way or in Southeast Asia. Despite this overage in total munitions, there are still shortages in some of the weapons that are most effective in suppressing enemy air defenses and interdicting lines of communications.

~~SECRET~~

designed to improve weapons systems, munitions, intelligence, communications, sensors, etc., is required.

1. The first of these alternatives is to attack complete enemy target systems including the logistic routes utilizing the deep water ports. Inherent in this alternative is the requirement for increasing the scope of operations in North Vietnam. To pursue this alternative as a course of action, it will be necessary to overcome or minimize the political impact of increasing targeting authority. Increased operations should permit a campaign against all the means of importing war materials into North Vietnam and against the remaining important military and war supporting targets. This is by far the most efficient method of applying military pressure on the enemy and of decreasing the total costs of US operations. Closure of these routes would, for the first time, make it militarily profitable and sound to close the roads and railroads to China. The enemy, with his access to outside aid drastically reduced, would be unable to import POL, trucks, building material and munitions necessary to support his forces and the flow of men and material into South Vietnam. This course of action would weaken and eventually neutralize the NVN Air Defense System. It would permit an intensive and effective air campaign that could have a major psychological and military impact. Effective closure of enemy access to Russian and Communist Chinese weapons and munitions would have two important additional effects: First, foreclosure of the ability of the Soviet Union to increase the technological capability of the NVN Air Defense System. Second, the imponderables relative to the will of North Vietnam to continue the conflict would be simplified. The enemy could be deprived of the means to continue effective opposition to US objectives. His will to continue would become less of a factor. In this situation, the termination of effective operations in South Vietnam, whether or not negotiated, would occur. This course of action offers the greatest probability of favorable decision in FY 68 and should be commenced at the earliest opportunity consistent with satisfactory weather conditions and adequate stocks of equipment and munitions.

2. The second alternative is to maintain present target authority and constraints while increasing the effectiveness

~~SECRET~~

IV-7

facilitate the diversion of aircraft as necessary between areas of responsibility of the Navy and Air Force. Further, the system of coordination in use has demonstrated a degree of flexibility, tactical versatility and responsiveness which, if centralized, would be difficult to retain.

b. The currently programmed netting of the tactical data systems will provide a more rapid means for the fusion and display of intelligence and operational data to the various operational commanders. The system will not add new information; however, it will make information available sooner. The major problem in netting the systems is in developing proper interfaces to make the systems compatible. An interface has been developed between NTDS and MTDS. Development of the interface between BUIC II and MTDS/NTDS, if required, remains to be accomplished.

c. Available sensors have been employed, largely, to support effective SAM and MIG warning and border violations systems. US forces have yet to make more than token use of the products of these sensors, fused with all source intelligence, in support of quick reaction offensive operations. There is a real potential in this area for probing the enemy's vulnerabilities and in limiting his use of radars and operation of training flights. Projected reaction operations require fused elements of COMINT, ELINT and all source intelligence; useable, fast and secure communications; and suitable strike assets. These requirements are currently at hand to a degree that modest operations, at least, could begin now. A further element of coordination and control that has not been exploited is the use of Special Intelligence (SI) with other sensor products, for surface-to-air missile operations against airborne enemy fighters.

D. ³ ~~(S)~~ ALTERNATIVE COURSES OF ACTION. The investigations of this study effort indicate two principal courses of action. (The theoretic alternative of halting air operations over North Vietnam is clearly unacceptable from any viewpoint. A further alternative, an anti-air campaign, is ancillary to basic issues and is discussed under section C.) With either of the alternatives, continuation, initiation or expansion of actions defined in this report and

~~SECRET~~

PART V - CONCLUSIONS AND RECOMMENDATIONS

A. (S) CONCLUSIONS

1. North Vietnam has developed a formidable air defense system that has greatly complicated the US air campaign against North Vietnam.

2. The NVN Air Defense System is capable of readily incorporating and effectively employing further qualitative and quantitative improvements.

3. The NVN Air Defense System is entirely dependent upon external sources of resupply.

4. Complete intelligence is not available regarding the amount and means of importation, or whether large central areas or depots exist for the storage and maintenance of air defense materials.

5. The authorized scope of air operations thus far has not been sufficient to deny the enemy access to externally supplied war material or to prevent the continuing growth of his lines of communication and air defenses.

6. Since May 1966, US aircraft attrition rates in North Vietnam have steadily decreased. For planning purposes it should be assumed that this trend is temporary.

7. A conclusive campaign against the entire air defense system is not feasible at this time because US forces do not possess the non-nuclear weapons systems and munitions to conduct a successful campaign, or the authority to effectively impede the flow of supplies from external sources. All SAMs cannot be eliminated because of the inability to locate them accurately. AAA guns, communications facilities, and radars are too difficult to locate and too numerous to be eliminated. US forces do possess the equipment necessary to eliminate the MIG threat.

~~SECRET~~

~~SECRET~~

of the US air operations by technological improvements and more effective use of existing equipments. This course of action would require no new political decisions. However, it is complicated by the demonstrated ability of North Vietnam to make force build-ups and weapons improvements at a rate equal to or exceeding those of the United States. The ability of the enemy to do this is based on the limits of Soviet technology, the willingness of the Soviet Union and Communist China to provide such support, and the capability of the enemy to move weapons, munitions, and advisory personnel into position. If past US policies continue, the enemy will apparently retain these requisites to continue matching or surpassing US improvements. Therefore, the attainment of US military objectives by improved weapons and procedures requires that such improvements have a sufficient margin of superiority and quickness of effect to succeed before the Soviet Union and Communist China can react with countering force build-ups and/or improved technology. The difficulty of achieving the required margin of forces and technical superiority over the enemy is illustrated by the inability of the United States to achieve this margin during the past two years. Consequently, this course entails a major scientific and production effort, and increased force requirements; followed by a surge of effort, in order to achieve US objectives in North Vietnam before the Soviet Union and Communist China can effectively react. Additionally, if the opponents did successfully counter, the air war would thereafter be conducted at a higher level of technological conflict and attrition. This alternative offers little hope of achieving an early decision and would very probably require operations for an indefinite period beyond FY 68.

~~SECRET~~

~~SECRET~~

15. Coordination and control procedures are adequate to support present air operations and are sufficiently flexible to accommodate to expanded operations.

16. US capability to fuse all elements of intelligence for tactical exploitation can and should be improved.

17. Netting of the semi-automated data systems, currently available in or programmed for Southeast Asia, will improve the support provided to US aircraft operating over North Vietnam through more timely fusion and display of tactical intelligence and operational data at major control activities.

18. There are currently no major differences in the tactical air problems of 7th AF and 7th FLT except those associated with bases, distances, and routes to the targets.

19. Current delivery tactics of the US Navy and US Air Force are basically the same.

~~SECRET~~

~~SECRET~~

8. There is a scarcity and consequently restrictive rationing of the most effective weapons and fuzes needed to suppress enemy guns and surface-to-air missiles. There is a lack of improved mines, bombs, and fuzes to prolong the damaging effects of attacks on bridges, roads, railroads, and waterways.

9. US forces do not possess the non-nuclear weapons systems and munitions required to successfully interdict the NVN logistics system during prolonged periods of adverse weather. Further improvement and expansion is required in night and all-weather attack capability.

10. In late March, the transition to the southwest monsoon should bring six months of relatively good weather. Although they will be short of the most effective weapons systems and munitions, US forces will have enough substitute systems and munitions to impede the importation of air defense material into North Vietnam during the forthcoming good weather period. This can be done while continuing to impede the flow of material to the south.

11. Improved electronic, infrared and visible light systems are needed to locate, in near real time, enemy radar, antiaircraft weapons, surface vehicles, and shipping with accuracies sufficient for effective attacks.

12. As the enemy's passive and active air defenses improve, free fall bombs and unguided rockets become progressively less efficient against pinpoint targets. A new family of non-nuclear munitions is required. They should be capable of accurate delivery from outside the envelope of the target's defenses.

13. A need exists for a high-speed armed VTOL aircraft with sufficient range, endurance, and payload capacity to effectively accomplish the SAR mission in enemy areas.

14. Special intelligence now available to 7th AF and CTF 77, when used in conjunction with other intelligence, can provide assurance that violations of Chinese air space can be avoided. The same intelligence has an unexploited potential for use in support of expanded operations against the NVN Air Defense System.

~~SECRET~~

c. All thermal power plants and other war supporting industrial complexes.

d. NVN aircraft (airborne or not), and airfield facilities.

e. Lines of communication within North Vietnam. Continue air interdiction (including aerial mining of coastal and inland waterways) and naval gunfire.

OTHER RECOMMENDATIONS

C. (S) INTELLIGENCE

3. That improved equipment and procedures be developed to provide tactical intelligence of a perishable nature to users on a real time or near real time basis. That more detailed information be obtained on the import, routing, and storage of military material. That improved procedures be developed to identify and locate radar sites, filter centers, and SAM support facilities. That a coordinating group be established to collate special intelligence and operational intelligence in order to better evaluate the effectiveness of US and NVN tactics.

DIA
CINCPAC
NSA

D. (S) SPECIAL INTELLIGENCE

4. That the acquisition and installation of additional communications required for the rapid reporting and use of available special intelligence be expedited. These communications include:

CINCPAC

a. A second KY 8 circuit between the 6924th Security Squadron at Danang and the TACC(NS).

b. KY 8 communications between the BIG LOOK/COMMANDO LANCE aircraft and the TACC(NS) and PIRAZ ship.

RECOMMENDATIONS*

E. ~~(S)~~ PRINCIPAL RECOMMENDATIONS

1. That a broad air campaign against North Vietnam be started now with four basic objectives:

CINCPAC
JCS
OSD

a. To reduce to the lowest practicable degree the flow of imports into North Vietnam.

b. To continue to reduce to the lowest practicable degree the flow of military supplies to South Vietnam.

c. To destroy the remaining NVN military targets and war supporting industrial sites.

d. To produce an impact, by the accumulative effect of la, b, and c, that will reduce the will of the North Vietnamese government to continue to wage war.

2. That the targeting plan for this campaign include all targets of military value except the population itself. The following should be included among its first priority targets:

CINCPAC

a. Deep water ports.

The alternative means of impeding the flow of supplies through the port complexes are:

(1) A naval blockade of the Gulf of Tonkin.

(2) Mining or blocking channels approaching deep water ports plus attack on the off-loading and immediate distribution areas.

(3) Attack on the off-loading and immediate distribution areas.

b. Northeast and northwest rail lines.

* Where appropriate, the agency or agencies having primary cognizance of the subject is indicated.

~~SECRET~~

c. Equipping selected aircraft with Low Light Level Television (LLLTV) and Forward Looking Infrared (FLIR) sensor/weapons systems now.

d. Increasing the Navy A-6 force level by 33 percent now; and review the program to assess requirements for further expansion.

e. Expediting installation of an MSQ-77 system at Site 85 in Laos.

f. Expediting the development and testing of modifications to existing bomb delivery systems.

g. Emphasizing night and all-weather strike capability in a larger percentage of future weapons systems.

11. That corrective action be taken, through modification and redesign programs to reduce the vulnerability of US tactical aircraft to hits from small arms fire and AAA fragments. Possible modifications include:

SERVICES

a. Reticulated foam in fuel tanks.

b. Self-sealing fuel tanks.

c. Alternate flight controls; with emphasis on mechanical back-up.

d. Selective armor plating.

e. Fire suppressant system.

f. Smoke suppressant systems.

~~SECRET~~

c. Planning to assure that EC-121K "RIVET TOP" aircraft have KY 8 communications with TACC(NS) and the PIRAZ ship.

d. Provision to TF-77 of the rapid, secure communications required to effectively net the units afloat into a homogenous special intelligence collection and reporting unit.

e. Provision of KC 135 "LUZON" radio relay aircraft with the capacity to relay four, or more, channels of discreet frequency communications.

5. That 24-hour coverage of special intelligence be provided by on-station aircraft, rather than the daylight to dark coverage which now exists.

CINCPAC
NSA

6. That NSA Project "YOGI BEAR" be fully supported.

CINCPAC

7. That the TACC(NS) be authorized to receive and use, in a non-SI area, appropriately sanitized special intelligence. This is now being done in the Combat Information Centers aboard TF-77 ships.

NSA
CINCPAC

8. That the use of SAR DD/PIRAZ ships to perform certain special intelligence collection be evaluated (See Annex F to Appendix J).

CINCPAC
NSA

9. That the use of technical research ships for special intelligence collection in the northern Tonkin Gulf be evaluated (See Annex G to Appendix J).

CINCPAC
NSA

E. (S) STRIKE CAPABILITY

10. That the strike capability of US forces be improved by:

OSD
JCS
CINCPAC
SERVICES

a. Using Marine Corps A-6A aircraft in an expanded role in North Vietnam.

b. Deploying, as an interim measure, the RF-55 as a pathfinder and attack bomber--if current tests prove such employment feasible.

The current trend should be continued to develop a basic munition capable of various modes of delivery, fuzing, and composition. Munitions delivered by dispensers should be capable of delivery at various altitudes with several fuzing and bomblet options. Bomb and fuzing options should be selectable from the cockpit. The availability of area denial weapons for use in mixed strike loads should be increased to deny the enemy access to areas US forces have attacked.

G. (S) ELECTRONIC SYSTEMS

14. The following electronic warfare and related programs should be accomplished in Fiscal Years 1967 - 1968:

SERVICES
OSD
CINCPAC

- a. Initiate a priority program for long lead-time production items to equip 25 percent of the F-4D aircraft with TOA and a like percentage of the Navy attack aircraft with EELS.
- b. Provide EA-3B data readout Technical Electronic Warfare Support (TEWS) equipment to PACFLT carriers.
- c. Assign the highest priority to the installation of Radar Homing and Warning (RHAW) and self-protection countermeasures for all US aircraft flying over North Vietnam.
- d. Initiate an RA-5C improvement program to provide real-time readout and to insure correlation between the passive ECM and photographic capabilities against electronically emitting targets which are within photographic range.
- e. Expedite deployment of 13 additional EB-66B/E aircraft.
- f. Deploy QRC-160-8 jammer pods and ALQ-100 deceptive repeaters for S and C-band coverage as soon as possible following successful flight tests.
- g. Equip intercept aircraft with either GAINTIME, APX-76 and/or TEASER.

~~SECRET~~

F. (S) MUNITIONS

12. That action be taken on selected munitions programs as indicated:

OSD
CINCPAC
SERVICES

- a. Authorize procurement of Standard ARM in accordance with JCS 1725/613-5, dated 7 March 1967.
- b. Select a second source contractor for WALLEYE as soon as possible, and increase planned production by at least 100 units per month.
- c. Authorize limited production of TALOS ARM.
- d. Expand the capacity of production and loading activities (Picatinny, Milan, Joliet, Kansas) for CBU-24/29 to cover expanding requirements.
- e. Increase production of BLU-31/B from 200 per month to 1,500 per month as soon as possible.
- f. Expedite Navy qualification of BLU-34/B; but proceed with production for the Air Force, now.
- g. Review expenditure requirements for BLU-42 and BLU-45 mines.
- h. Increase production of Destructor MK-36 kits by at least 1,400 per month.
- i. Develop adequate fuze options for all munitions.

13. That munitions be procured in sufficient quantities to allow Southeast Asia commanders to build rapidly to the 45 day stock objective, while at the same time offering the flexibility to select the best ordnance to achieve stated military objectives.

SERVICES
OSD
CINCPAC

~~SECRET~~

~~SECRET~~

t. Install destruct features (thermal or explosive) in all new electronic warfare equipment.

u. Install KY-28 communications speech security equipments in all aircraft operating in North Vietnam.

15. The following electronic warfare and related programs should be accomplished beyond FY 1968.

OSD
SERVICES
CINCPAC

a. Expedite the development of optical countermeasures to degrade the effectiveness of visually aimed AAA weapons.

b. Initiate a priority program to extend the inverse LORAN techniques to include countering all pulsed radars in S, C, and X-bands.

c. Install LORAN D in Southeast Asia and procure microminiaturized automatic LORAN C/D receivers for Air Force strike and attack aircraft.

d. Expedite the development of systems capable of providing positive identification of airborne targets.

e. Develop IR detectors for the detection of ground-to-air, air-to-air, and air-to-surface missiles.

f. Expedite on an urgent priority the development of IR countermeasures capable of deflecting IR missiles in flight.

g. Expedite development of the Tactical Electronic Reconnaissance System (TEREC) for the RF-111 aircraft.

h. Expedite development of the 1000 series jammers for the EA-6A and follow-on aircraft.

i. Expedite the development of a carrier-based aircraft capable of tactical ELINT/COMINT collection and real-time analysis.

~~SECRET~~

~~SECRET~~

- h. Equip PIRAZ and SAR ships, and air/ground warning and control stations, with TEASER or the QRC-248.
- i. Install the ASQ-96 passive receiver in 16 EB-66C/D aircraft.
- j. Authorize sufficient funding for procurement of 100 QRC-335 (S and C-band) radar and fuze jammers to counter SAM and AAA radars and missile fuzing.
- k. Initiate intense ECM development efforts to counter SA-3 with compatible design and packaging for strike and attack aircraft.
- l. Provide program funding for the development and production of a high power jammer to jam missile and AAA fuzes.
- m. Increase production of ALQ-76 jammers from 48 to 108.
- n. Procure 15 additional EA-6A aircraft now, and authorize procurement of EA-6s at the rate of four operating aircraft per Navy Air Wing, and nine per Marine Air Wing.
- o. Initiate development of VHF, UHF, S and C-band expendable jammers with associated dispensers.
- p. Expedite procurement of EKA-3B aircraft equipped with ALT/27/ALQ-92 jammers.
- q. Initiate development of equipments capable of active/passive ranging to targets.
- r. Expedite procurement of 50 QRC-272/MRC-108 real-time passive ECM systems, as an interim measure until delivery of EA-6A, EA-6B, EKA-3B, modified EB-66, and improved RA-5C aircraft.
- s. Procure and deploy sufficient EC-121M aircraft (or EP-3A replacements) to permit 24 hour coverage in the present role, with the option for periodic operations with two aircraft on station.

~~SECRET~~

~~SECRET~~

PART VI - GLOSSARY OF CODE NAMES

- BARREL ROLL - Armed reconnaissance and strike operations in northern Laos.
- BIG EYE - USAF EC-121 airborne early warning aircraft used for MIG warning and CHICOM border warning.
- BIG LOOK - USN EC-121 tactical electronic intelligence collection aircraft used for MIG/SAM warning.
- BLUE SPRINGS - Photo reconnaissance program over North Vietnam utilizing drones.
- BLUE TREE - Pre and post strike photo reconnaissance program to support ROLLING THUNDER operations.
- CHARGER HORSE - A Navy project to net, by rapid and secure communications, the Special Intelligence units aboard CTF 77 vessels.
- COMBAT PROOF - Ground controlled radar bombing system (MSQ-77) used with USAF B-52 and tactical fighter strike operations.
- COMBAT LIGHTNING - USAF Tactical Air Control System to control air operations over North Vietnam.
- COMMANDO LANCE - NSA ELINT/COMINT collection program utilizing USAF C-130 (previously called SILVER DAWN) and used for MIG/SAM warnings.
- IRON HAND - USAF/USN armed reconnaissance and strike operations against SAM installations in North Vietnam.

~~SECRET~~

H. (S) SEARCH AND RESCUE

16. That a search and rescue (SAR) aircraft be developed which combines the characteristics of increased speed, longer range all-weather search and rescue capability, and reduced vulnerability to ground fire.

OSD
SERVICES

I. (S) COORDINATION AND CONTROL

17. That an executive agent be appointed to accomplish the interface among the tactical data systems in Southeast Asia in accordance with the tactical communications standards established in JCS Pub 10.

JCS
CINCPAC

J. (S) ANALYSIS

18. That continuing analysis of US air operations over North Vietnam be performed by permanently assigned and coordinated staff groups in OJCS and PACOM.

JCS
CINCPAC

~~SECRET~~

IRON HORSE -

An NSA automated system by which Special Intelligence information will be made available in near real time. To be netted with compatible USN/USMC/USAF systems.

PIRAZ -

Positive Identification and Radar Advisory Zone (Also the term used to identify the CLG/DLG which performs the function in the Gulf of Tonkin).

ROLLING THUNDER -

Air strike and armed reconnaissance program in North Vietnam.

SEEK DAWN -

USAF automated facilities being installed in Thailand and South Vietnam as part of COMBAT LIGHTNING project.

STEAM VALVE -

USN interim ship-shore HF secure voice program.

STEEL TIGER -

Armed reconnaissance and strike operations in southern Laos.

TIGER HOUND -

Air strike program in southeast Laos against troops, vehicles and supplies.

TROJAN HORSE -

High altitude (U-2) photo/ELINT reconnaissance operations.

WILD WEASEL -

USAF tactical fighters (F-105F) configured with special electronic equipment for location and attack of active SA-2/AAA radars.

YANKEE STATION -

Geographic area of operations of naval forces in the Gulf of Tonkin.

YANKEE TEAM -

Photo reconnaissance program in support of air operations over Laos.

YOGI BEAR -

An NSA equipment package to make Special Intelligence immediately available to operating forces.

~~SECRET~~

JOINT BRIEFS OF STAFF
OFFICIAL FILE COPY
JCS RAIR BRANCH 28030

NIGHT SONG STUDY GROUP REPORT

VOLUME II (of III)

AN EXAMINATION OF US AIR OPERATIONS AGAINST THE NVN AIR DEFENSE SYSTEM

911/351 (4 JAN 67) IR 236

THIS VOLUME CONTAINS SENSITIVE MATERIAL

~~SECRET~~
Regraded
Date: 30 MARCH 1979
Authority: DoD 5200.1-R

#1232 REVIEW FEB '90

GROUP-3
DOWNGRADED AT 12 YEAR
INTERVALS; NOT
AUTOMATICALLY DECLASSIFIED

JOINT CHIEFS OF STAFF
OFFICIAL FILE COPY
JCS BARR BRANCH 28030

EXCISED UNDER THE PROVISIONS OF THE
FREEDOM OF INFORMATION ACT 5 USC 552

SERIES B

Copy No. 35 of 75 Copies

RE: JCS 2343/990-2

~~SECRET NOFORN~~

NIGHT SONG STUDY GROUP
REPORT (U)

AN EXAMINATION OF US AIR OPERATIONS
AGAINST THE
NVN AIR DEFENSE SYSTEM

VOLUME II

~~SECRET~~

30 MARCH 1967
DAD 5200.1-12

PREPARED BY:

CHAIRMAN,
NIGHT SONG STUDY GROUP
JOINT CHIEFS OF STAFF
30 March 1967

GROUP 3. DOWNGRADED AT 12
YEAR INTERVALS, NOT AUTO-
MATICALLY DECLASSIFIED.

SPECIAL HANDLING REQUIRED
NOT RELEASABLE TO FOREIGN
NATIONALS.

~~SECRET NOFORN~~

JOINT CHIEFS OF STAFF
OFFICIAL FILE COPY
JCS AIR BRANCH 23080

~~SECRET~~

AN EXAMINATION OF US AIR OPERATIONS
AGAINST THE NVN AIR DEFENSE SYSTEM

TABLE OF CONTENTS

VOLUME II

APPENDIX A - GENERAL

- ANNEX A - Deputy Secretary of Defense Memorandum Requesting an Examination of US Air Operations Against the NVN Air Defense System
- ANNEX B - Implementing Directive and Terms of Reference
- ANNEX C - Composition of NIGHT SONG Study Group
- ANNEX D - Units Visited and Key Personnel Contacted
- ANNEX E - Glossary of Code Names

APPENDIX B - BASIC CONSIDERATIONS

APPENDIX C - DIGEST OF CONCEPTS AND RECOMMENDATIONS OF THE JOINT CHIEFS OF STAFF REGARDING AIR OPERATIONS AGAINST NORTH VIETNAM

APPENDIX D - NORTH VIETNAM AIR DEFENSE SYSTEM

- ANNEX A - Radar
- ANNEX B - Antiaircraft Artillery
- ANNEX C - Surface-to-Air Missiles
- ANNEX D - Possible Future Improvements in the Surface-to-Air Missile System
- ANNEX E - North Vietnam Air Force
- ANNEX F - Command and Control
- ANNEX G - Effectiveness of US Operations
- ANNEX H - NVN Weapons Effectiveness
- ANNEX I - An Analysis of NVN Air Defense Command and Control System as a Target System
- ANNEX J - Personnel and Training
- ANNEX K - Weather Factors
- ANNEX L - Logistics and Support
- ANNEX M - Effects of Reduction of Importation on NVN Air Defense

~~SECRET~~

~~SECRET~~

- ANNEX N - System Deficiencies and Vulnerabilities
- ANNEX O - Probable World Reactions to Expansion of US Air Actions in North Vietnam
- ANNEX P - Intelligence Gaps and Uncertainties
- ANNEX Q - Conclusions
- ANNEX R - Bibliography

APPENDIX E - WEAPON SYSTEMS AND MUNITIONS

- ANNEX A - Aircraft
- ANNEX B - Munitions
- ANNEX C - Navigation and Sensors
- ANNEX D - Electronic Warfare
- ANNEX E - Enemy Electronic Counter Countermeasures (ECCM) Summation

APPENDIX F - CURRENT TACTICS

- ANNEX A - Future Tactics

APPENDIX G - COORDINATION AND CONTROL

- ANNEX A - US Navy Operations
- ANNEX B - US Air Force Operations
- ANNEX C - US Marine Corps Operations
- ANNEX D - Communications
- ANNEX E - Coordination Procedures
- ANNEX F - Fusion of US Air Control and Data Processing System in Southeast Asia

APPENDIX H - ANALYSIS OF AN ANTI-ANTI-AIR CAMPAIGN AGAINST NORTH VIETNAM

~~SECRET~~

~~SECRET~~

APPENDIX A

GENERAL

1. (S) Directive

On 10 January 1967 the Deputy Secretary of Defense forwarded a memorandum to the Secretary of the Navy, Secretary of the Air Force, Chairman, Joint Chiefs of Staff, Director of Defense Research and Engineering, and Director, Defense Intelligence Agency, taking cognizance of the improved effectiveness of the air defense system of North Vietnam and requesting an examination of the US tactical air campaign against that system. The memorandum is attached at Annex A.

2. (S) Terms of Reference

On 20 January 1967, the Chairman, Joint Chiefs of Staff, issued Terms of Reference for the study and appointed a chairman and vice chairman of the study group. The Terms of Reference are at Annex B.

3. (U) The composition of the Night Song Study group is shown at Annex C. A list of units visited and key personnel contacted is attached at Annex D. A glossary of code names is included at Annex E.

~~SECRET~~



SECRET
THE DEPUTY SECRETARY OF DEFENSE
WASHINGTON 25, D.C.

10 January 1967

MEMORANDUM FOR Secretary of the Navy
Secretary of the Air Force
Chairman, Joint Chiefs of Staff
Director of Defense Research and Engineering
Director, Defense Intelligence Agency

Over the last year, the air defense system of North Vietnam (NVN) appears to have improved steadily in quality and effectiveness. During this period, the attrition rates of U.S. tactical aircraft have been maintained at low levels through the effective utilization of resources and the high competence of the crew members and commanders involved. Maintaining these levels in the future may be more difficult if the North Vietnamese continue to improve their air defense system by:

- Improved pilot training and MIG utilization.
- Improved air control and the integrated use of SA-2 missiles and MIG interceptors.
- Increased use of radar controlled weapons.
- More sophisticated use of flak-traps.
- Improved and modified SA-2 defenses.
- Possible introduction of heat-seeking missiles of the RED-EYE and CHAPPARAL variety.

The R&D organizations of the Navy and Air Force have responded to the changing North Vietnamese air defense threat by initiating developmental efforts to improve sub-systems for jamming, locating emitters, improving munitions and ARM-type missiles.

However, in light of the relatively high aircraft attrition in some areas of Route Packages V and VI, I believe a re-examination of the U.S. tactical air campaign against the NVN air defense system would be appropriate. This study, to be completed by 15 March 1967, should include:

- (1) a reassessment of the NVN air defense system in terms of its weaknesses, strengths, and critical operational elements;

~~SECRET~~

AA-1

Annex A to
Appendix A

~~SECRET~~

- (2) a detailed analysis of the technical and tactical factors which influence the existing and future capabilities of U.S. tactical air forces to cope with, and selectively destroy or counter, the NVN air defense system;
- (3) a complete identification and analysis of differences in the tactical air problems of the 7th Fleet and the 7th Air Force in conducting the air campaign against the NVN air defense system; and
- (4) a complete analysis of the degree of compatibility and the technical adequacy of the tactical command, control, and communications systems employed in the air campaign against NVN.

The study outlined above should be undertaken jointly by the Navy and Air Force. The Chairman, Joint Chiefs of Staff, is requested to develop and issue terms of reference for the study and, after consultation with the Chief of Naval Operations and the Chief of Staff, USAF, to designate a chairman of the study group. The Chairman, JCS, may also provide an OJCS representative on the joint Navy/Air Force study group.

When the study is completed, it should be analyzed first by CINCPAC. His analysis and the basic study would then be reviewed by an OJCS/OSD Review Group to be chaired by the Director of Defense Research and Engineering (DDR&E). The Chairman, JCS, and the DDR&E should determine the membership of the Review Group. The results of the OJCS/OSD review would then be submitted to the Secretaries of the Navy and Air Force and the Joint Chiefs of Staff for their respective comments and recommendations.

The Director, DIA, is requested to provide whatever intelligence information the joint Navy/Air Force study group or the Review Group requires. The Director, DIA, should also provide personnel to work with the joint Navy/Air Force study group and the OJCS/OSD Review Group.

/s/ Cyrus Vance
Sec Def Cont Nr.X-204

~~SECRET~~

AA-2

Annex A to
Appendix A



THE JOINT CHIEFS OF STAFF
WASHINGTON 25, D. C.

CM-2073-67
20 January 1967

MEMORANDUM FOR: Chief of Naval Operations
Chief of Staff, US Air Force

SUBJECT: Study to Reexamine the US Air Campaign Against the
NVN Air Defense System

1. Reference is made to the Deputy Secretary of Defense memorandum, dated 10 January 1967, SECDEF Control Number X204, which requested the Navy and Air Force to undertake a joint study on the subject. The reference also requested the Chairman, Joint Chiefs of Staff, to develop and issue Terms of Reference for the study and in addition, after consultation with the Chief of Naval Operations and the Chief of Staff, US Air Force, to designate a chairman of the study group.

2. The Enclosure hereto contains the Terms of Reference.

3. In consonance with the above, and subject to your concurrence, I have appointed Major General J.B. McPherson, USAF, Vice Director for Operations, J-3, OJCS, as the chairman of the study, and Rear Admiral F.A. Bardshar, USN, Chief, Requirements and Developments Division, J-3, OJCS, as the vice chairman of the study group.

/s/ EARLE G. WHEELER
Chairman
Joint Chiefs of Staff

Enclosure
A/S

~~SECRET~~

AB-1

Annex B to
Appendix A

~~SECRET~~

ENCLOSURE

TERMS OF REFERENCE

Subject: Study to Reexamine the US Air Campaign against the NVN Air Defense System (U)

1. Reference is made to Deputy SECDEF memo dated 10 Jan 67, SECDEF Cont N. X204, that requested the Navy and Air Force to undertake a joint study on the subject and that the Chairman, JCS, develop and issue terms of reference for the study.

2. The terms of reference for the study are:

a. Purpose. To reexamine the US air campaign in NVN against the NVN air defense system.

b. Time. The study will convene on or about 23 Jan 67 at the call of the chairman and present the completed study to CINCPAC for analyses on or about 15 Mar 67.

c. Membership. The study group will be composed of Navy and Air Force members and representatives of the JCS. The Chairman will be Major General J. B. McPherson, USAF, Vice Director for Operations, J-3, OJCS. The Vice Chairman will be Rear Admiral F. A. Bardshar, USN, Chief, Requirements and Development Division, J-5, OJCS.

d. The study will include:

(1) A reassessment of the NVN air defense system in terms of its weaknesses, strengths, and critical operational elements, including projected qualitative and quantitative growth.

(2) An analysis of the technical and tactical factors which influence the existing and future capabilities of US tactical forces to cope with, and selectively destroy or counter the NVN air defense system. Pursuant to this, investigate the possibilities of early achievement of specific capabilities to include:

(a) To track and identify all aircraft over NVN and the Tonkin Gulf and effect, if required, positive direction of friendly aircraft in these areas.

~~SECRET~~

AB-2

Annex B to
Appendix A

(b) To locate and destroy enemy radiation sources of all frequencies.

(c) To degrade the enemy's air defense logistic system by monitoring and attacking enemy surface movements in and around NVN during all conditions of weather and visibility.

(d) To attack elements of the enemy's air defense system by the expanded use of our integrated weapon system composed of fighter aircraft, surface-to-air missiles, and electronic warfare equipment.

(e) To conduct air operations while employing communication deception or radiation silence for selected times and areas.

(f) To destroy vital components of the enemy's air defense system such as command and control centers and communication networks.

(g) To achieve an adequate supply in types and quantities of new air munitions to cope with NVN air defenses.

(3) In addition to achievement of capabilities listed above, systems will be measured by time of availability including personnel and logistic support consideration prior to FY-68, during FY-68 and after FY-68, compatibility of equipment for inter-Service and intra-Service use, expected useful life of the equipment or system and equipment versatility or ability to perform multiple functions.

(4) An examination of tactics relative to integration of new or improved equipment.

(5) An identification and analysis of differences in the tactical air problems of the 7th Fleet and the 7th Air Force in conducting the air campaign against the NVN air defense system.

(6) An analysis of the degree of compatibility and technical adequacy of the tactical command, control, and communications systems employed in the air campaign against NVN appropriate to the realization of improved effectiveness and coordination of the 7th Fleet and the 7th Air Force air operations.

~~SECRET~~

(7) Fusion of the elements of intelligence in a manner providing the tactical air commands with timely information on airborne and surface target sufficient for operationally effective reactions.

(8) A consideration of the above factors with others as recognized by the JCS in JCSM 651-66, dated 10 October 1966, as they interact to affect the US air campaign in NVN.

(9) Other factors as determined during the course of the study.

e. The study group will reach conclusions and make recommendations.

f. Administration. The Director, Joint Staff, will provide administrative support for the study group including required office space and administrative support personnel.

g. CINCPAC will be invited to provide liaison representation during the preparation of the study.

GROUP 3
DOWNGRADED AT 12 YEAR INTERVALS;
NOT AUTOMATICALLY DECLASSIFIED

Enclosure

~~SECRET~~

AB-4

Annex B to
Appendix A

~~SECRET~~

ANNEX C TO APPENDIX A

COMPOSITION OF NIGHT SONG STUDY GROUP

Chairman: Major General John.B. McPherson, USAF, J-3

Vice Chairman: Rear Admiral F. A. Bardshar, USN, J-5

OJCS: Colonel Henry W. Hise, USMC, OJCS, J-3

Colonel Robert K. Dusenberry, USAF, OJCS, J-6

Colonel Carl E. Zeigler, USAF, OJCS, J-5*

Colonel H.M. Darmstandler, USAF, OJCS, J-3

Commander James H. Cullen, USN, OJCS, J-3

Major Glen K. Matsumoto, USA, OJCS, J-3*

Army: Lt Colonel Lowell B. Torseth, USA, AFSTC*

Navy: Captain Jack M. James, USN, OPNAV

Captain William G. Coulter, USN, OPNAV

Captain Ralph J. Mattus, USN, OPNAV

Captain Randell H. Prothro, USN, OPNAV

Captain Warren H. O'Neil, USN, OPNAV

Captain Herbert E. Camp, USN, OPNAV

Commander Erick N. Swenson, USN
NAVSHIPSYSCOMD

Commander Charles E. Langton, USN, ONI

Commander Claude J. Tetrick, USN
NAVORDSYSCOMD*

Commander Robert E. Spruit, USN, OPNAV

*Part time consultant or liaison representation

~~SECRET~~

AC-1

Annex C to
Appendix A

~~SECRET~~

Commander William W. Gay, USN, OPNAV*
Commander Frederick C. Palmer, USN, OPNAV*
Lt Commander James M. Pugh, USN, ONI*
Lt Commander Chester H. Lohr, USN, ONI*
Lt Commander John D. Thomas, USN, OPNAV*
Lieutenant Raymond A. Rundle, USN, HSS*
Lieutenant Albert G. Bush, USN, OPNAV
Mr. George Haering, GS-17, OPNAV
Dr. Robert Hubbard, Contractor, CNA (OEG)*
Mr. John M. Donachy, Contractor, CNA (OEG)*
Mr. Almer Crim, Contractor, NAVORDSYSCOMD*
Mr. Ferdinand F. Neider, Contractor, CNA (OEG)*
Mr. Melvin C. Keebaugh, Contractor,
Airtronics Inc.
Mr. Howard W. Kreiner, Contractor,
Airtronics Inc.*

Air Force: Colonel Dale S. Sweat, USAF, TAC
Colonel Monroe S. Sams, USAF, Hq USAF
Colonel Cyril E. Williams, USAF, Hq USAF
Colonel David M. Critchlow, USAF, Hq USAF
Colonel Jerry F. Hogue, USAF, Hq USAF
Colonel William B. Craig, USAF, Hq USAF
Lt Colonel Denver M. Porter, USAF, Hq USAF
Lt Colonel William H. Ginn, Jr., USAF, Hq USAF

*Part time consultant or liaison representation

~~SECRET~~

AC-2

Annex C to
Appendix A

~~SECRET~~

Lt Colonel Theodore F. DeMuro, USAF, Hq USAF
Lt Colonel Irwin J. Levy, USAF, Hq USAF
Lt Colonel Edward F. Kelly, USAF, Hq USAF*
Lt Colonel Ralph A. Bass, USAF, Hq USAF
Lt Colonel Donald D. Hawkins, USAF, Hq USAF
Lt Colonel Harold V. Wright, USAF, Hq USAF*
Major Richard J. Hall, USAF, Hq USAF
Captain Richard A. Riddle, USAF, Hq USAF
Captain Charles N. Dixon, USAF, TAC
Major Jerrell W. Brooks, USAF, Hq USAF
Mr. David E. Anderson, GS-14, AFGOA*
Mr. Bernard Kornhauser, GS-14, AFGOA
Marine Corps: Colonel Edward S. Fries, USMC, CMC, (AAM)*
Colonel Thomas H. Miller, USMC, CMC
CINCPAC: Colonel Harry S. LaSalle, Jr., USAF
CINCPAC Hq*
CINCPACFLT: Captain Theodore M. Smyer, USN,
CINCPACFLT Hq*
CINCPACAF: Colonel William T. Whisner, USAF, PACAF Hq*
Major Homer N. Willett, USAF, PACAF Hq*
CIA: Mr. J. Casey, GS-13, CIA*
DIA: Captain Robert E. Adams, USN, DIA
Commander James R. Parce, USN, DIA
Lieutenant Scott S. Shenton, USN, DIA
NSA: Mr. D. C. Lang, GS-14, NSA
WSEG: Colonel Vito S. Pedone, USAF, WSEG*

~~SECRET~~ *Part time consultant or liaison representation

AC-3

Annex C to
Appendix A

~~CONFIDENTIAL~~

ANNEX D TO APPENDIX A

UNITS VISITED AND KEY PERSONNEL CONTACTED

1. (C) During the period 19 February through 7 March 1957, the Chairman, Vice Chairman, and other selected members of the study group visited CINCPAC Headquarters and key personnel of the following operating units in Southeast Asia. The list of personnel contacted is not complete; it is intended, rather, to depict by representation the extent to which the experience and expertise of key personnel intimately involved with the question addressed herein has been sought by the study group.

a. Tan Son Nhut (Saigon), South Vietnam, 7th AF Headquarters.

- (1) LGen Momyer, USAF, Commander, 7th Air Force
- MGen Graham, USAF, Vice Commander
- BGen Hendry, USAF, Assistant Chief of Staff
- BGen Dunham, USAF, Deputy for Operations
- BGen Philpot, USAF, Deputy for Intelligence
- EGen McGough, USAF, Assistant Deputy for Operations (Out of Country)
- Col Wallace, USAF, Assistant to BGen McGough
- Col Horn, USAF, Alpha Team
- Col Forbes, USAF, Bravo Team
- Col Anderson, USAF, Reconnaissance
- Col Widner, USAF, PACAF SEAOR Coordination Group
- Col Hageman, USAF, Assistant to Deputy for Operations

~~CONFIDENTIAL~~

AD-1

Annex D to
Appendix A

~~CONFIDENTIAL~~

Col Witry, USAF, Electronic Warfare

Capt Yates, USN, Navy Liaison to 7th AF

LCol Krepnik, USAF, Tactics

LCol Flaherty, USAF, NIGHT SONG Project
Officer

LCol Ritter, USAF, Alpha Team

LCol Leiser, USAF, Alpha Team

Capt Carraway, USAF, Special Security Officer

(2) 460th Tactical Reconnaissance Wing

Col Williams, USAF, Commander

b. Seventh Fleet

VAdm Hyland, USN, Commander, 7th Fleet

c. Yankee Station

(1) USS ENTERPRISE (CVA(N)65)

RAdm Mehle, USN, Commander (CTG-77.0)

Capt Holloway, USN, Commanding Officer,
USS ENTERPRISE CVA (N)65)

Cdr Shipman, USN, Commander (CAW-9)

Cdr Barie, USN, Commanding Officer (VA-34)

Cdr Smith, USN, Commanding Officer (VA-56)

Cdr Sherman, USN, Executive Officer (VA-56)

Cdr Ryan, USN, Commanding Officer (RVAH-6)

Cdr Rough, USN, Commanding Officer (VF-92)

~~CONFIDENTIAL~~

AD-2

Annex D to
Appendix A

(2) USS TICONDEROGA (CVA-14)

Capt Miller, USN, Commanding Officer.
USS TICONDEROGA (CVA-14)

Cdr Phillips, USN, Commander (CAW-19)

Cdr Conklin, USN, Commanding Officer (VF-191)

Cdr Merchant, USN, Commanding Officer (VA-52)

(3) USS KITTY HAWK (CVA-63)

RAdm Richardson, USN, Commander (TF-77)

Capt Pugh, USN, Commanding Officer
USS KITTY HAWK (CVA-63)

Capt Conaster, USN, Chief of Staff (TF-77)

Capt Gorsline, USN, Operations Officer (TF-77)

d. Danang Air Base, South Vietnam

(1) IIIrd Marine Amphibious Force

LGen Walt, USMC, Commanding General

Col Doyle, USMC, Chief of Staff

LCol Talbert, USMC, Officer in Charge TADC

Maj McManus, USMC, MTDS Project Officer

(2) 1st Marine Air Wing

MGen Robertshaw, USMC, Commanding General

BGen Owens, USMC, Vice Commanding General

(3) IIInd Marine Air Group

Col Guss, USMC, Commander

CONFIDENTIAL

(4) VMCJ-1

LCol Fleming, USMC, Commanding Officer

(5) 6294th Security Squadron

Maj Ardisaria, USMC, Commanding Officer

(6) 366th Tactical Fighter Wing

Col Rankin, USAF, Commander

Col Randels, USAF, Deputy Commander

Col Stanfield, USAF, Deputy for Operations

Capt Riley, USAF, Electronic Warfare Officer

(7) Tactical Air Control Center

Col Williams, USAF, Commander

e. Udorn Air Base, Thailand

(1) 7th AF/13th AF (Thailand)

MGen Bond, USAF, Commander

Col Hayes, USAF, Chief of Staff

Cdr Buck, USN, Navy Liaison Officer

(2) 432nd Tactical Reconnaissance Wing

Col Shick, USAF, Commander (R-FAC and R-101)

Col Kuhlmann, USAF, Deputy for Operations

Col Kissiek, USAF, Deputy for Intelligence
(EB-56C)

(3) IIInd Tactical Reconnaissance Squadron

LCol Estes, USAF, Commander

CONFIDENTIAL

AD-4

Annex D to
Appendix A

~~CONFIDENTIAL~~

(4) 20th Tactical Reconnaissance Squadron

LCol Stirling, USAF, Commander

Maj Beverly, USAF, Tactics

f. Utapao Air Base, Thailand

(1) 4258th Strategic Bomb Wing

Col Farrar, USAF, Commander

(2) 635th Combat Support Group

Col Brock, USAF, Commander

g. Korat Air Base, Thailand

(1) 388th Tactical Fighter Wing

Col Chairsell, USAF, Commander

Col Johnson, USAF, Deputy for Operations

Maj White, USAF, (WILD WEASEL) Operations

(2) 1974th Communications Group

Col Brown, USAF, Commander

LCol Talbert, USAF, Operations

h. Takhli Air Base, Thailand

(1) 355th Tactical Fighter Wing

Col Scott, USAF, Commander

Col Broughton, USAF, Deputy Commander

Col Hill, USAF, Deputy for Operations

(2) Tactical Reconnaissance Wing

Col Gordon, USAF, Deputy Commander (EB-66B)

~~CONFIDENTIAL~~

AD-5

Annex D to
Appendix A

~~CONFIDENTIAL~~

(3) 332nd Tactical Fighter Squadron

LCol Salmon, USAF, Commander

(4) 354th Tactical Fighter Squadron

LCol Gast, USAF, Commander

(5) 357th Tactical Fighter Squadron

LCol Murphy, USAF, Commander

i. Ubon Air Base, Thailand

(1) 8th Tactical Fighter Wing

Col Olds, USAF, Commander

Col Garrison, USAF, Deputy Commander

Col James, USAF, Deputy for Operations

Maj Bloomcamp, USAF, Tactics Officer

(2) BIG EYE Detachment

LCol Peck, USAF, Commander

j. Guam

3rd Air Division

MGen Crum, USAF, Commander

BGen Kline, USAF, Deputy Commander

Col Johnson, USAF

k. Okinawa

Sobe Joint Processing Center

Col Harrold, USAF

~~CONFIDENTIAL~~

AD-o

Annex D to
Appendix A

~~CONFIDENTIAL~~

1. Fleet Intelligence Center Pacific Facility

Cubi Point, Philippines

Briefing by Officer in Charge and all Division
Chiefs

~~CONFIDENTIAL~~

AD-7

Annex D to
Appendix A

~~SECRET~~

GLOSSARY OF CODE NAMES

ANNEX E TO APPENDIX A

BARREL ROLL - Armed reconnaissance and strike operations in northern Laos.

BIG EYE - USAF EC-121 airborne early warning aircraft used for MIG warning and CHICOM border warning.

BIG LOOK - USN EC-121 tactical electronic intelligence collection aircraft used for MIG/SAM warning.

BLUE SPRINGS - Photo reconnaissance program over North Vietnam utilizing drones.

BLUE TREE - Pre and post strike photo reconnaissance program to support ROLLING THUNDER operations.

CHARGER HORSE - A Navy project to net, by rapid and secure communications, the Special Intelligence units aboard CTF 77 vessels.

COMBAT PROOF - Ground controlled radar bombing system (MSQ-77) used with USAF B-52 and tactical fighter strike operations.

COMBAT LIGHTNING - USAF Tactical Air Control System to control air operations over North Vietnam.

COMMANDO LANCE - NSA ELINT/COMINT collection program utilizing USAF C-130 (previously called SILVER DAWN) and used for MIG/SAM warnings.

IRON HAND - USAF/USN armed reconnaissance and strike operations against SAM installations in North Vietnam.

~~SECRET~~

AE-1

Annex E to
Appendix A

~~SECRET~~

IRON HORSE - An NSA automated system by which Special Intelligence information will be made available in near real time. To be netted with compatible USN/USMC/USAF systems.

PIRAZ - Positive Identification and Radar Advisory Zone (Also the term used to identify the CLG/DLG which performs the function in the Gulf of Tonkin).

ROLLING THUNDER - Air strike and armed reconnaissance program in North Vietnam.

SEEK DAWN - USAF automated facilities being installed in Thailand and South Vietnam as part of COMBAT LIGHTNING project.

STEAM VALVE - USN interim ship-shore HF secure voice program.

STEEL TIGER - Armed reconnaissance and strike operations in southern Laos.

TIGER HOUND - Air strike program in southeast Laos against troops, vehicles and supplies.

TROJAN HORSE - High altitude (U-2) photo/ELINT reconnaissance operations.

WILD WEASEL - USAF tactical fighters (F-105F) configured with special electronic equipment for location and attack of active SA-2/AAA radars.

YANKEE STATION - Geographic area of operations of naval forces in the Gulf of Tonkin.

YANKEE TEAM - Photo reconnaissance program in support of air operations over Laos.

YOGI BEAR - An NSA equipment package to make Special Intelligence immediately available to operating forces.

~~SECRET~~

AE-2

Annex E to
Appendix A

~~SECRET~~

APPENDIX B

BASIC CONSIDERATIONS

A. (S) GENERAL

1. Basic to any analysis of the US air campaign against North Vietnam is the consideration of several significant factors which have influenced US air operations to date and must be expected to influence the formulation and conduct of future air operations; whether directed against the over-all threat from North Vietnam or against the specific threat posed by its air defense system.

2. These significant factors can be grouped into four categories. The first involves a consideration of US military objectives, capabilities, and logistic requirements for conducting the air campaign. The second encompasses an analysis of enemy capabilities and logistic requirements to nullify the effects of US air operations, and the influence of this additional enemy effort upon his capability to direct or support the insurgencies in South Vietnam and Laos. The third category involves consideration of the physical factors of the theater, including weather, terrain, hydrography, national boundaries, distances, and base locations. The fourth deals with the consideration of US national objectives and commensurate high level decisions regarding the intensity and scope with which the air war may be conducted. Following is a discussion of these four groups of basic considerations.

B. (S) GROUP I - US MILITARY OBJECTIVES, CAPABILITIES, AND LOGISTIC REQUIREMENTS

1. US Military Objectives. The objective of the US air campaign has been to cause Hanoi to cease its aggression in South Vietnam, and to make continued support of the Viet Cong insurgency as difficult and costly as possible. US policy has been to achieve this by steadily increasing military pressure against North Vietnam. Tasks to accomplish the objective are:

a. Reduce or deny external assistance to North Vietnam.

~~SECRET~~

b. Disrupt and destroy in depth those resources that contribute most to support of the aggression.

c. Harass, disrupt, and impede movement of men and materials to Laos and South Vietnam.

2. US Capabilities. The illustration at TAB A shows the actual and planned US sorties, ordnance expenditures and aircraft losses of US air operations in North Vietnam.

3. US Supporting Structure. Total programmed US sortie capability in Southeast Asia is shown at TAB B. The gross tonnages of air munitions available to US forces in Southeast Asia are depicted at TAB C.

C. (S) GROUP II - ENEMY OBJECTIVES, RESOURCES AND DEFENSES

1. Enemy Objectives. The derived enemy objectives relative to US tactical air operation in North Vietnam are to defeat or overcome the effects of US air operations by:

a. improving the air defenses of North Vietnam to impose increasing losses on US aircraft

degrading US bombing effectiveness

c. countering the effects of US air operations by compulsory activity

d. replacing losses by outside aid and effecting net gain

e. depicting North Vietnam as a victim of US aggression and using tactical and propagandic pressures to inhibit or disrupt US air operations

f. continuing political and military efforts throughout Southeast Asia

2. Enemy Resources. Resources supporting air defense systems and subversive efforts in Southeast Asia:

~~SECRET~~

B-2

Appendix B

a. The Government. The government, a communist dictatorship, exchanges recognition with and receives aid from the communist world. It seeks international recognition and unification of all of Vietnam under communist control through political/insurgent action.

b. Military Alliances and Agreements. Military alliances are prohibited under the 1954 Geneva Agreement; however, Communist China has openly stated that it is ready to assist in the defense of North Vietnam. Surface-to-air missiles, artillery, vehicles and communications equipment, as well as aircraft and naval craft, have been provided by communist bloc countries. Communist China and the Soviet Union provide military support and train both officers and NCOs of the North Vietnamese Armed Forces; including jet pilots.

c. Agriculture, Economy and Lines of Communications

(1) North Vietnam is predominantly an agricultural country with about 80 percent of the labor force engaged in this activity.

(2) The gross national product for 1965 was estimated at \$1.639 billions (US) the equivalent of \$92 (US) per capita. Major industries are food processing, textiles, machine building, mining and cement. Main import needs are petroleum, machinery and equipment.

(3) Total non-military aid during the period 1955 to 1964 was \$956.4 million (US). Of this amount Communist China supplied \$457 million, the Soviet Union \$369 million, and the East European Communist countries \$130 million. Non-military aid received by North Vietnam during 1965 was about \$150 million.

(4) It is estimated that there are 566 route miles of single track, metergauge (3' 3 3/8" wide) 65 route miles of dual gage (3' 3 3/8" and 4' 8 1/2") and approximately 25 route miles of single track standard gage (4'8") rail lines. Of 7,000-8,000 miles of highways, all are earth and gravel except

for about 700 miles of all-season roads. There are 3,380 miles of inland waterways, of which 1,500 miles are navigable by shallow-draft river steamer during high water (May-November) and about 900 miles are navigable perennially. There are 13 ports; one principal (Haiphong), two secondary, and ten minor.

(5) The NVN Merchant Marine consists of four cargo ships and two tankers, totaling 8,493 gross registered tons. The air transport fleet consists of 54 aircraft. There are 15 airfields believed to have been in use since 1964. Of these, 10 have permanent surface runways and 12 have runways in excess of 4,000 feet in length. Four of the airfields are currently unserviceable as a result of US air strikes. One additional airfield is under construction.

(6) Most lines of communication in North Vietnam are subject to seasonal conditions. Only a small portion of the highways are of all-season. Construction, and tide and seasonal rainfall have a significant effect on inland waterways.

d. Armed Forces.* Total military personnel strength (in-country):

Army	358,600
Navy	2,500
Air Force	3,700 (estimated)
Security Forces	<u>16,500</u>

TOTAL 381,300

(1) Army. Army personnel strength in-country is 358,600. Additionally, there are an estimated 61,510 NVN Army personnel in Laos and South Vietnam. North Vietnam is organized into 10 infantry divisions (in-country), one artillery division, one AAA division, four infantry brigades, eight independent infantry regiments, one armored regiment, 80 AAA regiments, and 25-30 SA-2 battalions.

*Source: DIA Southeast Asia Military Fact Book

~~SECRET~~

B-4

Appendix B

(2) Navy. Navy personnel strength is 2,500. The NVN Navy inventory consists of 36 torpedo and patrol boats plus 35 service craft.

(3) Air Force. Air Force personnel strength is estimated to be 3,700, including cadre elements and trainees. The NVN Air Force has a total of 232 aircraft. The aircraft inventory includes 124 jet aircraft, of which 113 are fighters, eight light bombers, and three trainers; and 109 prop aircraft, of which 54 are transports, 26 helicopters, and 29 trainers. About 32 MIG 15/17s and two IL-28s are dispersed in China.

(4) Surface-to-Air Missile Defense. All of the vital areas of North Vietnam in the Red River delta and the populated coastal regions south to the 18th parallel are within the potential SAM envelope. There are about 25-30 SAM battalions presently in operation in North Vietnam.

(5) Paramilitary Forces. The paramilitary forces (security forces of the Ministry of Public Security) has a personnel strength of 16,500.

(6) Reserves. Reserve forces consist of: Armed regional militia with headquarters elements in each provincial capital and units in each district; self-defense forces organized in government agencies and civilian industry for local security and air defense; and, a registered group--only partially armed, including overage, underage, and females--which has a potential reserve of about 3,000,000. These units give support to AAA defense units.

e. Military Aid. North Vietnam received the equivalent of over \$1,200 million (US) in military aid during the period 1955-1966 from the following countries: Communist China - \$100-120 million, USSR - \$1,100 million, and the European Communist countries about \$10 million.

f. Manpower Resources. Population: 17,895,000 as of 1 January 1966; males (ages 15-49), 4,146,000; physically fit, 2,110,000. The average number of

males currently reaching
about 175,000.

g. Mobilization Capacity (Army Forces). Since mid-1965, North Vietnam has been mobilizing at an increasing rate to provide for expanding commitments in South Vietnam and Laos. Manpower resources currently provide over 100,000 males annually for military service.

h. Air Defense System. Since the inception of US air operations against North Vietnam, the enemy air defense system has undergone more extensive change than any other NVN resource. All air defense weapons and munitions have been brought in from communist nations, chiefly China and Russia. Additional resources from these countries and the continued access of North Vietnam to these resources are therefore crucial to the present and future effectiveness, development and support of the NVN Air Defense System. The growth of the NVN Air Defense System is depicted at TAB D.

i. Concentration of Enemy Resources. The bulk of North Vietnam resources are concentrated in Route Packages V and VI. The following percentage of NVN national resources are located in these two route packages:

Population	60%
Industry	90-95%
Agriculture	65% of rice 85% of other
Roads (mileage)	60%
Railroads (mileage)	75%
Air Force (OB)	100%
Naval (OB)	100%
Ground	75%
Antiaircraft Artillery	70%
Surface-to-Air Missiles	80%
Deep Water Ports	100%
Railroad Rolling Stock	75% plus

SECRET

B-6

Appendix B

Additionally, all foreign aid passes thru this area and the majority of the military logistic base is located there.

j. Targeting Against Enemy Resources

(1) The above listed resources can be resolved into target systems. One of several possible sequential gradings relating the worth and vulnerability of NVN target systems and subsystems, is shown below:

<u>SHORT-TERM</u>	<u>LONG-TERM</u>
ELECTRIC POWER	1 PORT FACILITIES <u>a/</u>
PORT FACILITIES <u>a/</u>	2 ELECTRIC POWER
TRANSPORTATION	3 AIRFIELDS <u>b/</u>
AIRFIELDS <u>b/</u>	4 TRANSPORTATION
DIKES	5 DIKES
DAMS AND LOCKS	6 INDUSTRY
RAIL FACILITIES <u>a/</u>	7 DREDGES
INDUSTRY	8 FOOD
DREDGES	9 AIR DEFENSE
AIR DEFENSE	10 RAIL FACILITIES <u>a/</u>
SAMs <u>b/</u>	11 SAMs <u>b/</u>
RADAR <u>b/</u>	12 STORAGE AREAS
POL	13 POL
FOOD	14 DAMS AND LOCKS
TELECOMMUNICATIONS	15 RADAR <u>b/</u>
STORAGE AREAS	16 AAA <u>b/</u>
BRIDGES <u>a/</u>	17 COMMAND AND CONTROL <u>b/</u>
COMMAND AND CONTROL	18 BRIDGES <u>a/</u>
AAA <u>b/</u>	19 TELECOMMUNICATIONS

(2) Several of these target systems have not been attacked and none of them have been attacked in their entirety. As a consequence, the enemy has had sufficient respite and resources exempt from attack to adjust to the shortages and dislocations caused by US air operations. (TAB E is a graphic portrayal of authorized versus exempt target complexes in North Vietnam.)

(3) In this context, the ability of the enemy to obtain arms and munitions from outside sources

a/ LOC subsystems
b/ Air defense subsystem

has been of great importance. The importation of weapons over the rail lines from China and through deep water ports has been essential to continued enemy operations.

(4) US forces are authorized to attack the northwest rail line from Hanoi to China over 66 percent of its length and the northeast rail line over 62.5 percent of its length.

D. GROUP III - THE OPERATIONAL THEATER

1. Geography. North Vietnam has an area of about 63,000 square miles; approximately the size of the state of Washington. The greater part of the country is covered by rough mountains extending generally from northwest to southeast. West of the Red River, peaks range from 7,000 to 10,000 feet in height, but elsewhere heights are generally less than 6,000 feet. The principal rivers follow the same northwest-southeast trend. The most significant feature of the non-mountainous region is the triangular Red River delta plain which measures about 100 miles from its apex on the Red River to its 80 mile long base formed by the coast. This delta contains many watercourses. Coastal plains 5 to 50 miles wide extend southward from the delta; these plains and the delta are mostly rice fields. Forests interspersed with scrub and grass are found on the mountains. Because of flooded rice fields and rugged mountains, vehicular movement away from the roads is impracticable almost everywhere; except during the dry season in marginal areas of the delta and the coastal plains and in some parts of the wider valleys. Movement for men on foot is believed to be slow.

2. Climate. The climate is monsoonal, with a humid, hot and wet southwest season between May and September and a cool dry northeast season between October and March; however, in coastal regions a light continuous drizzle causing high humidity and poor visibility often occurs between January and April. The average annual rainfall at Hanoi is 66 inches. During the southwest monsoon the maximum temperatures range between 75 degrees fahrenheit in the mountains and 90 degrees on the plains, and the minimum between 64 and 80 degrees respectively. During the northeast monsoon the corres-

ponding maxima are between 50 and 70 degrees and the minima between 40 and 55 degrees.

3. Weather. The weather in Southeast Asia has a strong influence on military operations there. Of the two monsoons, the southwest monsoon has the greater effect on over-all military activity since it brings heavy rains to most of the country between May and September; one exception is the strip of land east of the coastal mountain range in central Vietnam which remains dry. A transitional season occurs in March and April and again in October. The latter precedes the northeast monsoon which lasts from November through February, bringing rain to the coastal area and gradual dryness to the land mass west of the mountains. The Northeast monsoon has a particularly adverse affect on air operations in North Vietnam. The low ceilings and protracted periods of low visibility over the Red River delta inhibit air attacks and favor air defense of the area.

4. Base Locations. The distance to major target areas in North Vietnam is shown at TAB F.

5. Route Packages. The division of route packages in North Vietnam is shown at TAB G.

E. (S) GROUP IV - US NATIONAL OBJECTIVES AND THE INTENSITY AND SCOPE OF THE AIR WAR

1. The effectiveness of US air operations in North Vietnam has been limited largely by the selected intensity and scope of US operations and to a lesser extent by the opposing enemy capabilities and objectives. Vital portions of the enemy logistic system have been exempt from attack and other portions of the system have been attacked only in part and often against the least important elements. To the present time, the limits of US national objectives have precluded the execution of a systematic US tactical air campaign designed to break vital enemy target systems. These limits have reduced the effectiveness of US air operations below that which could be obtained using the same forces with broader objectives and a wider spectrum of targets.

~~SECRET~~

~~SECRET~~

2. Although US air operations have impeded the flow, the enemy has not been deterred from continuing the input of men and supplies into South Vietnam. The limited US national objectives with respect to North Vietnam, and associated humane instincts to avoid civilian casualties, have been used by the communists as an effective propaganda tool to further restrict US air operations. At the same time, the enemy has taken advantage of US constraints to import and erect formidable air defenses. The United States is now faced with this growing threat from the enemy air defense system and (1) possible significantly increased aircraft losses; (2) increased pressures, both foreign and domestic, to cease air operations in North Vietnam; and (3) the uncertain value of air interdiction in slowing the movement of enemy personnel and supplies into South Vietnam.

3. It must be concluded that US tactical air operations have not applied adequate and steady pressure against the enemy. Imposed restrictions have resulted in the inefficient use of tactical air and the enemy has turned US restraints to his own propaganda advantage. The United States has three broad alternatives regarding the air war in North Vietnam:

a. Withdraw air operations against North Vietnam; in part or completely.

b. Maintain present objectives, authority and constraints and increase the effectiveness of US air operations by technological improvements and improved use of existing equipment.

c. Increase targeting authority to attack complete target systems and add technological improvements.

4. Complete or partial withdrawal of air operations against North Vietnam would be a military, political and prestige defeat for the United States. Such action would facilitate the movement of enemy personnel, equipment and supplies into South Vietnam and would almost certainly increase total American casualties. Such action would shorten the enemy supply lines that are vulnerable to attack and reduce the area that he must

~~SECRET~~

defend. Withdrawal of air operation against North Vietnam would result in an increase in the enemy's capability to support attacks at places and times of his choice. Consequently, it is by far the least desirable alternative.

5. The second alternative - maintaining present objectives, targeting authority and constraints while increasing the effectiveness of US air operations by technological improvements and by more intensive and effective use of existing equipments - would require no new or major decisions. This alternative assumes that improved use of US resources and technology can satisfactorily overcome the advantages that present US constraints afford the enemy. It also implies that within present constraints, the United States can prevent further growth in the effectiveness of the NVN Air Defense System and ultimately achieve the objectives of the air war. This alternative can be selected without corresponding readjustment of political factors - but it entails considerable military risks if the assumptions prove invalid. The NIGHT SONG Study Group explored the assumptions and potentialities of this alternative. It should be noted that technological and munition improvements recommended to support this alternative would have similar or increased value if the objectives of US air operations in North Vietnam were broadened.

6. The third alternative - increasing targeting authority to attack complete enemy target systems (including all deep water ports and logistics systems) would be the most efficient method of applying military pressure on the enemy and of decreasing the total costs of US operations. This alternative would permit an intensive air campaign to (1) exact a full price from the enemy in return for his efforts to conquer South Vietnam; (2) reduce the effectiveness of his air defense system; and (3) defeat his logistic system and consequently the military effort of North Vietnam. Disadvantages could include a short term increase in aircraft losses and increased criticism of US actions. From a military standpoint, this course of action is the most desirable. A digest of concepts and recommendations of the Joint Chiefs of Staff regarding the air campaign, including increased targeting authority, is contained at Appendix C.

TAB A TO APPENDIX B

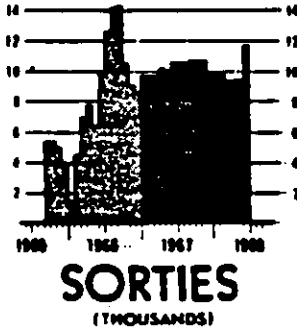

**US SORTIES, ORDNANCE
EXPENDITURES & AIRCRAFT
LOSSES-NORTH VIETNAM**

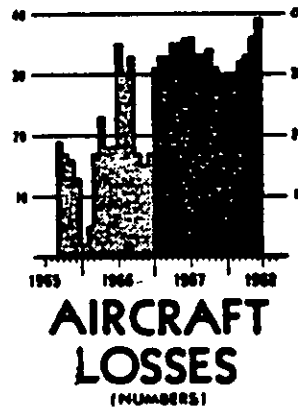

■ ACTUAL
■ PLANNED

TAB B TO APPENDIX B

SOUTHEAST ASIA ORDNANCE DELIVERY COMBAT SORTIES
(ATTACK, CAP AND ESCORT SORTIES)

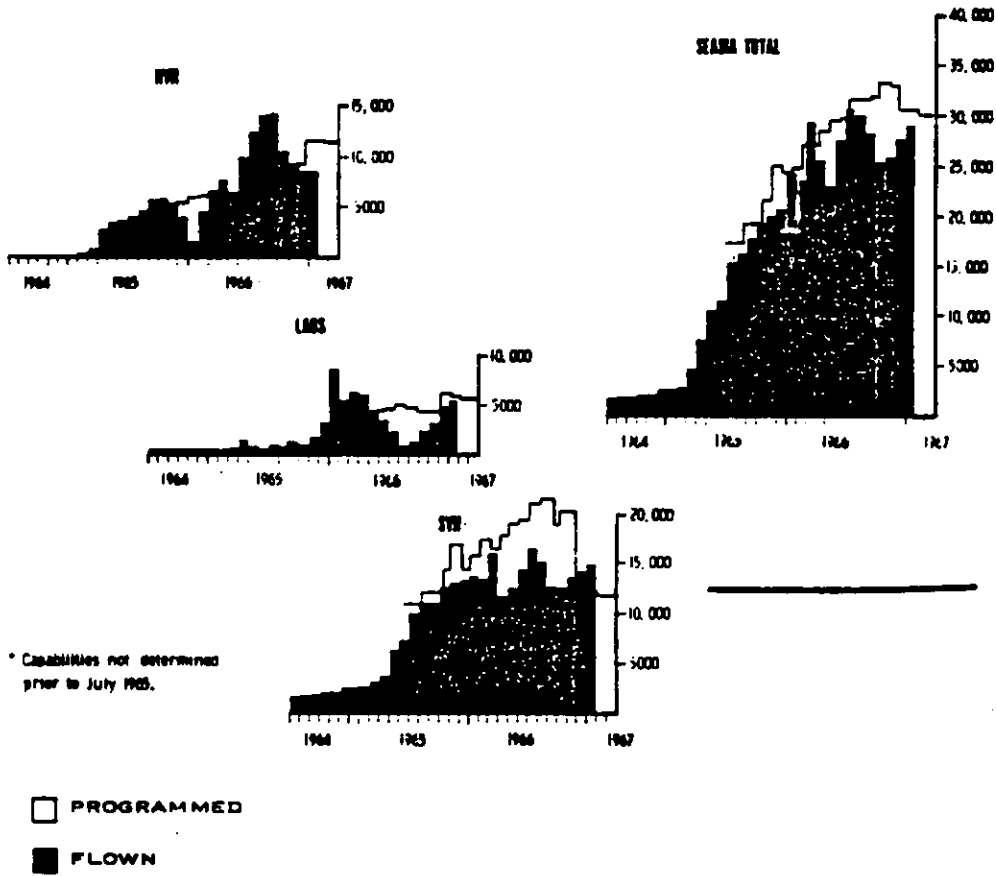

TAB C TO APPENDIX B

MUNITION AVAILABILITY IN SEA (IN TONS)
MAY 66 - JAN 68

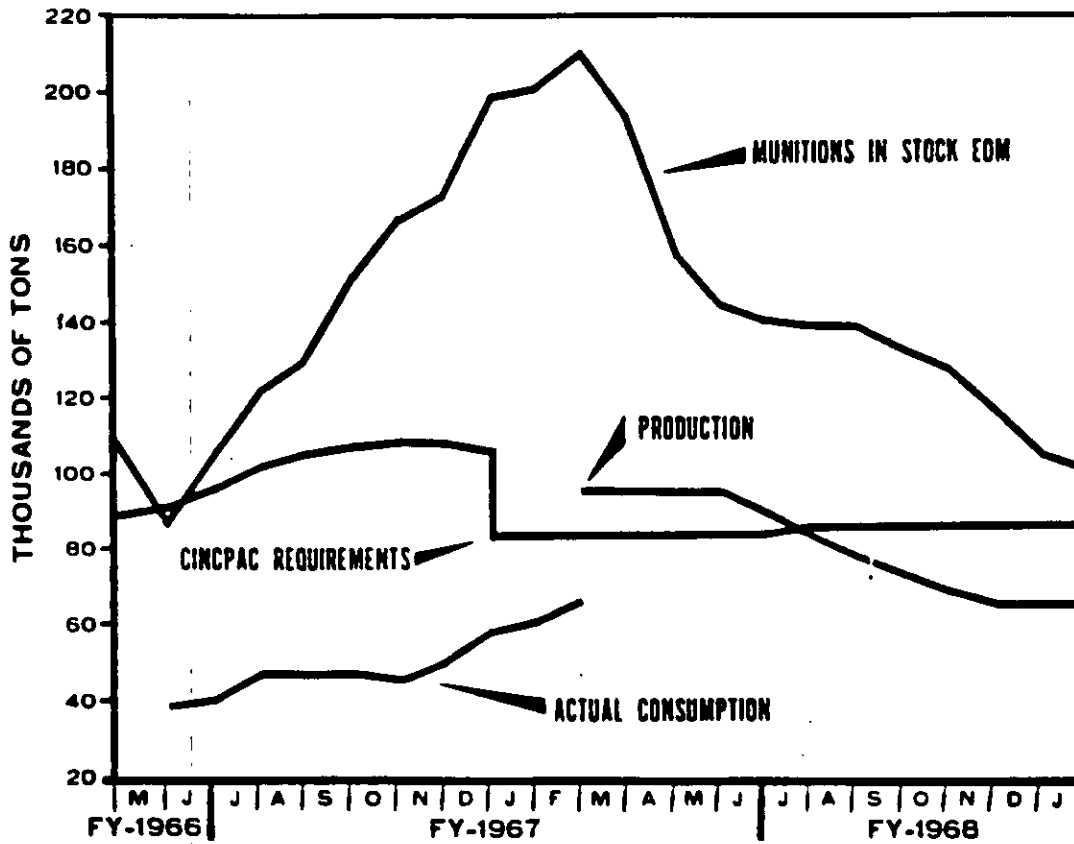

TAB D TO APPENDIX B

**GROWTH OF NORTH VIETNAMESE
AIR DEFENSE SYSTEM FROM 1964 TO MAR 67**

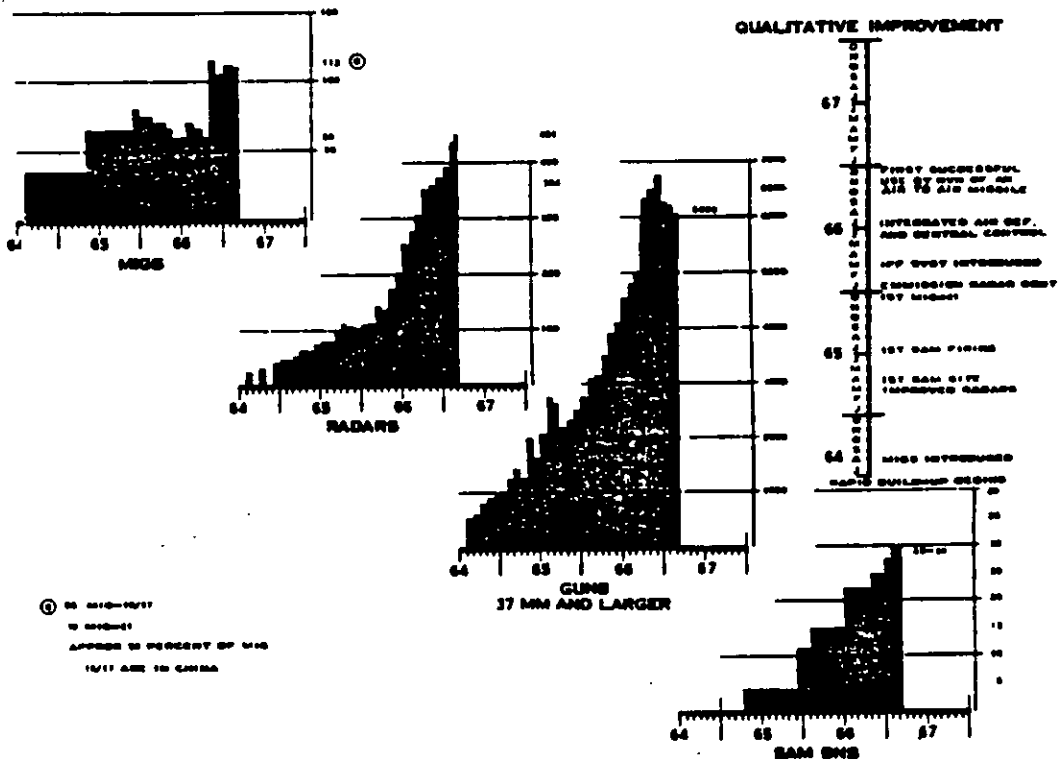

TAB D TO APPENDIX B

**AUTHORIZED/EXEMPT
NORTH VIETNAM TARGET COMPLEXES**

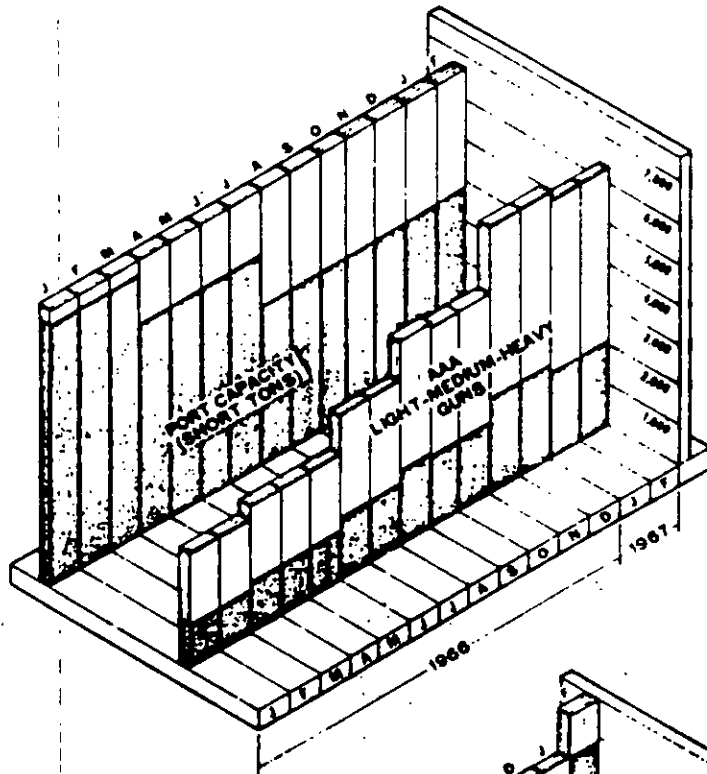

LEGEND
 [White Box] AUTHORIZED
 [Black Box] EXEMPT

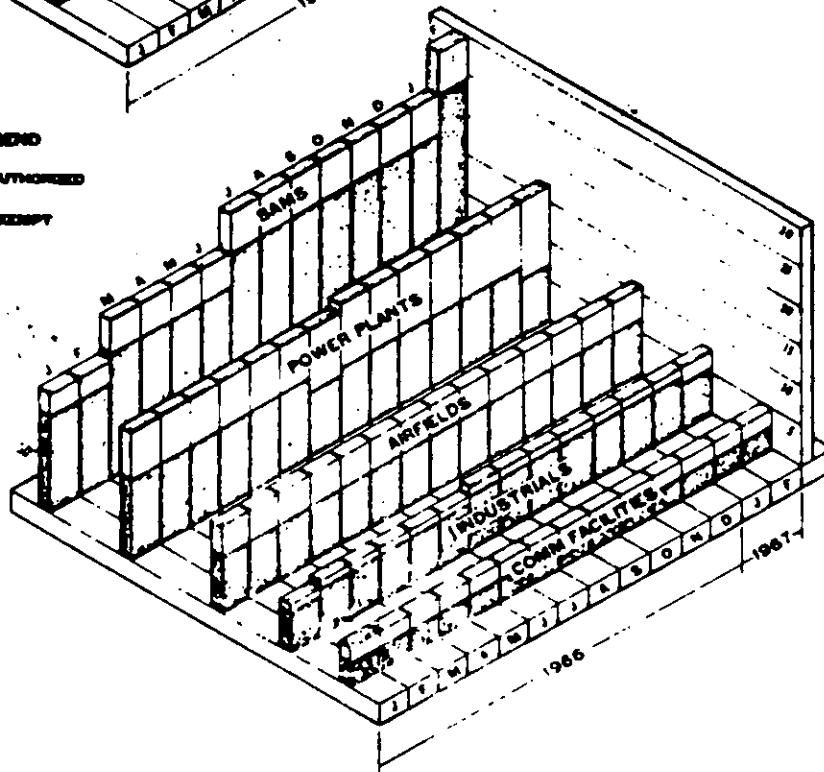

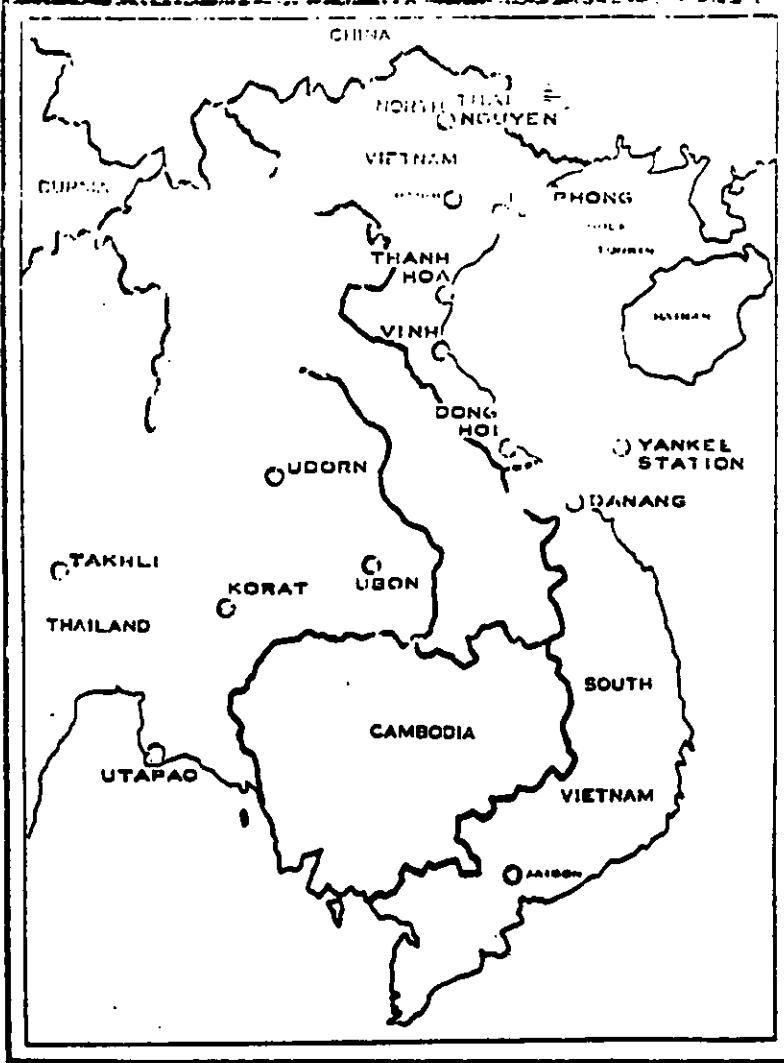

DISTANCES: BASE TO TARGET (NAUTICAL MILES)

BASE \ TARGET	DONG HOI	VINH	THAN HOA	HAIPHONG	HANOI	THAI NGUYEN
UTAPAO	550	640	690	725	660	640
TAKHLI	530	620	670	705	520	500
KORAT	430	520	570	605	510	490
UDORN	380	470	520	555	360	340
UBON	275	365	415	450	520	500
DANANG	145	235	285	320	370	390
YANKEE STATION	125	290	225	245	275	305
ACTUAL CVA OPERATING STATION	90	85	100	125	160	200

~~SECRET~~

TAB G TO APPENDIX B

ROUTE PACKAGES IN NORTH VIETNAM

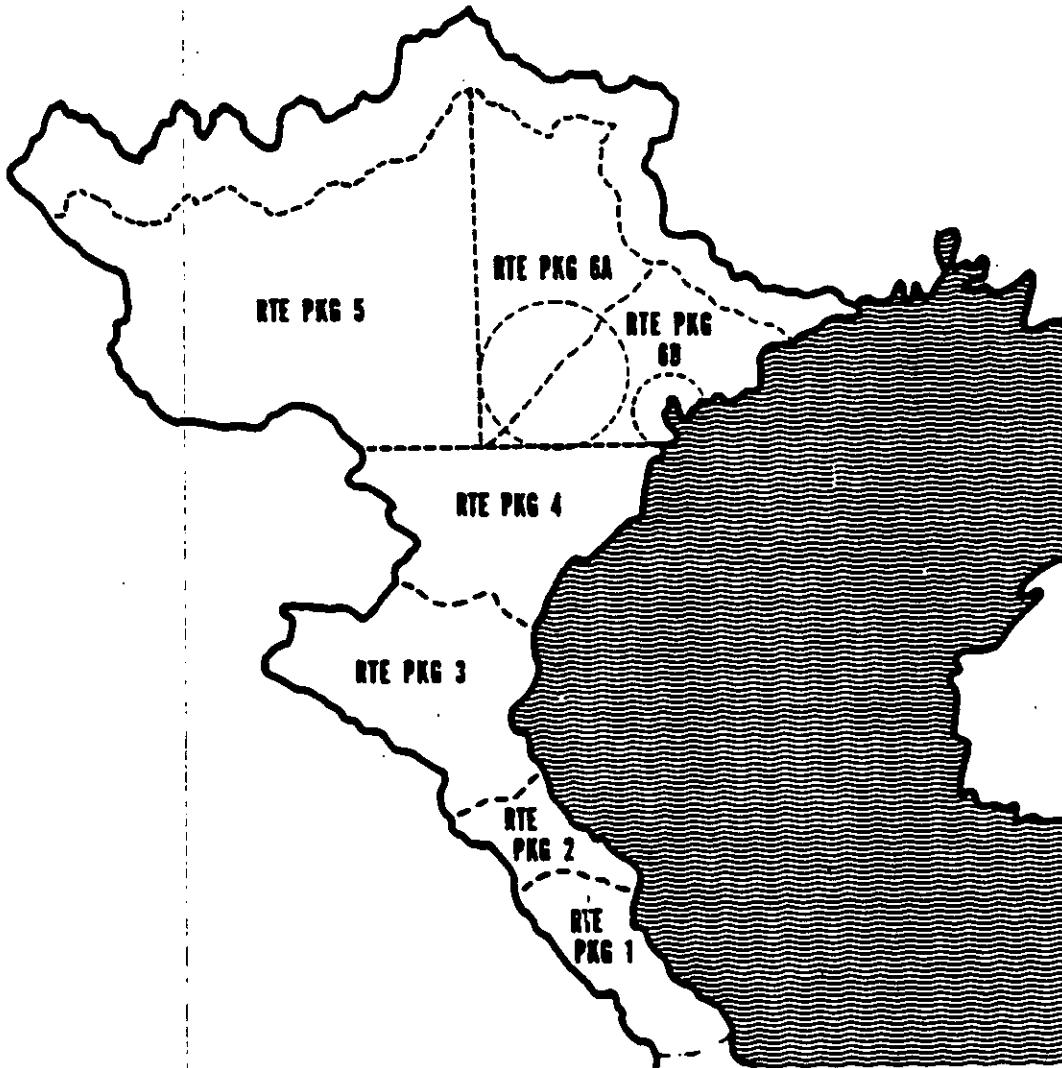

~~SECRET~~

BG-1

Tab G to
Appendix B

APPENDIX C
DIGEST OF CONCEPTS
AND
RECOMMENDATIONS
OF
THE JOINT CHIEFS OF STAFF
REGARDING
AIR OPERATIONS AGAINST NORTH VIETNAM

C-1

Appendix C

~~SECRET~~

OVERVIEW

The concepts and recommendations of the Joint Chiefs of Staff regarding air operations in North Vietnam have consistently supported the national objectives for US participation in Southeast Asia as expressed in National Security Action Memorandum (NSAM 288) and subsequent documents of higher authority. In addition, these concepts and recommendations have embodied the axiomatic principles of military strategy including: suddenness of attack, division of the enemy's strength, timeliness of action, enemy's reactions, and quick and decisive achievement of objectives. Intentionally, these concepts have represented escalatory actions with sufficient coercive impact to support strong political strategy in inducing the enemy to desist in the support of insurrection activity. Conversely, portions of the recommendations have been authorized for incremental implementation over the past two to three years vice the conceptualized plan period of two to three months.

~~SECRET~~

C-2

Appendix C

SUMMARY OF DIGNITY OF AIR CAMPAIGN CONCEPTS AND RECOMMENDATIONS

DATE	ICM#	CONCEPT	OPINIONS
27 Jan 64	46-64	Remove self-imposed restrictions and take stronger action against North Vietnam including: <ol style="list-style-type: none"> 1. Bombing critical targets 2. Mining sea approaches. 	No immediate military action developed.
2 Mar 64	174-64	Preliminary judgments re exerting increasing military pressure against North Vietnam.	SECDEF had requested these judgments. No immediate military action developed.
14 Mar 64	272-64	Concurrence in a 12 point program whose last point included "retaliatory actions" and "graduated overt military pressure" against North Vietnam.	The 12 points became a National Security Action Memorandum (NSAM 268). No immediate military action developed.
7 Jun 64	471-64	Three courses of action: <ol style="list-style-type: none"> 1. Destroy NVN will and capabilities to support external insurgencies. 2. Demonstration attacks. 3. Compromise between 1 and 2. 	First major attacks occurred on 5 Aug 1964 and 8-11 Feb 65.
5 Jun 64	489-64	High priority - low level reconnaissance.	No immediate military action developed; however, low-level reconnaissance was initiated on 10 Mar 65.
24 Aug 64	729-64	The 94-target study - five groups for sudden sharp blow: <ol style="list-style-type: none"> 1. Airfields. 2. LOCs. 3. Military installations. 4. Industrial installations. 5. Route Area Encumbrances. 	Limited action occurred on following dates: <ol style="list-style-type: none"> 1. 30 Apr 65. 2. 2 Apr 65. 3. 7 Mar 65. 4. 30 Apr 65. 5. 19 Mar 65.
26 Aug 64	746-64	More direct and forceful military actions against North Vietnam.	No immediate military action developed.
27 Oct 64	902-64	Retaliatory actions, low-level reconnaissance, and LOC strikes to be done immediately, followed by other, more severe, actions as required including amphibious assault.	No immediate military action developed; however, retaliatory strikes occurred in Feb 65 and the limited ROLLING THUNDER Program began in Mar 65.
4 Nov 64	933-64	Low-level recon, airfields, PCL, barracks, progressive strikes on 94 targets.	No immediate military action developed; however, in Mar 65 ROLLING THUNDER allowed a limited number of targets to be struck and recon commenced.
14 Nov 64	955-64	Reported 4 Nov recommendations with an analysis of DRV/CHICOM resources.	The JCS had been asked to examine possible military reactions of the DRV/CHICOM to US attacks on North Vietnam. Also, see previous remarks.
18 Nov 64	967-64	A set of objectives relative to a controlled program of systematically increased pressure. Also: <ol style="list-style-type: none"> 1. Low-level recon. 2. LOC attacks. 3. Aerial mining of ports. 4. Naval quarantine. 5. The 94-target list. 6. Retaliatory actions. 	This was subsequently defined by the JCS (JCSM 1001-64 of 1 Dec 1964) as a ten to three month program. Thus far, in two years, it has been partially adopted. No immediate military action developed at the time these recommendations were made.
23 Nov 64	987-64	Reported 6 Nov recommendations cast as the best of five courses of action.	See previous remarks.
28 Dec 64	1078-64	Attack on NVN barracks in reprisal for the enemy's attack on the RVN BQ.	Disapproved by higher authority.
11 Feb 65	100-65	Eight week program of attacks against DRV targets along Route 7 and south of 19th parallel to commence with retaliatory action.	A significant reduction in scope and intensity from previous recommendations. Not favorably acted upon; however, the targets were eventually struck as a result of subsequent recommendations.
27 May 65	415-65	Attacks on specific NVN air defense elements: <ol style="list-style-type: none"> 1. PHUC THIE IL-28/NIG Threat. 2. SA-2 site SE of Hanoi. 3. Other aircraft and associated PCL. 	Disapproved by higher authority; however, after an F-4C shoot-down by a SAM, the SA-2 sites were authorized for a special strike on 27 Jul 65.
11 Jun 65	477-65	Reported 27 May 65 recommendations plus increased ground recon and strikes on important military targets.	No immediate military action developed. See previous remarks.
26 Jun 65	498-65	Alternate course of action: <ol style="list-style-type: none"> 1. SAM Sites/NIG/IL-28s. 2. SAM Sites. 	Not favorably acted upon; however, the SA-2 sites were authorized for strike on 27 Jul 65 and ground recon included SAM sites on 11 Aug 65.
6 Aug 65	608-65	Two specific actions: <ol style="list-style-type: none"> 1. Aerial Mining. 2. Increased LOC interdiction north of 20th parallel. 	The first river mining action occurred 12 Mar 67 and the increased LOC interdiction was partially implemented on 1 Sep 65.

DATE	ICM#	CATEGORY	DETAILS
27 Aug 65	652-65	Basis strategy for United States to follow in support of national objective in Vietnam (R24M-388) including:	SECRET agreed but asked that recommendations for future operations in Southeast Asia should be formulated and submitted for individual consideration as they are developed. An immediate action over and above the tempo of the ROLLING THUNDER Program occurred.
7 Sep 65	670-65	Recommended target systems:	Authorized for attack as follows:
		1. Destruction of RVN/Military targets.	1. Not yet authorized.
		2. Interdiction RVN LOCs within and into the country.	2. 17 Sep 65.
		3. HANOI to HAIPHONG LOCs	3. 17 Sep 65.
		4. HAIPHONG POL	4. 29 Jun 66
		5. SAM and other air defense which interfere with above.	5. 1 Oct 65 (Partly).
11 Sep 65	686-65	Repealed 2 Sep 65 recommendations emphasizing the JCS view, for the future, that this program would minimize the risk to major forces and facilities and prevent escalation.	SECRET was not persuaded by the reasoning that the military advantages of the proposed program outweighed the attendant risks.
1 Jan 66	8-66	Right of hot pursuit in Southeast Asia.	SECRET replied on 16 May 66 that the right of hot pursuit existed in the rules of engagement if essential in defense of US forces, except in the case of the sea and air space of Communist China.
8 Jan 66	16-66	Early termination of stand-down.	Stand-down was terminated on 31 Jan 66 but not in the terms of the JCS recommendation.
18 Jan 66	41-66	To achieve primary military objectives:	Attacks were resumed on 31 Jan 66; however, none were in support of the recommendations.
		1. Attack area to include all North Vietnam except ton and four mile radius circle around Hanoi and Haiphong, respectively, and a 30 mile deep buffer zone along CHICOM border.	
		2. Remove operational airtie limitations on armed recon-	
		3. No tactical restrictions on specific strikes.	
25 Jan 66	56-66	Alternatives to 18 Jan 66 recommendations.	Same as previous remarks.
		1. Maximum armed recon.	
		2. Armed recon against southernmost LOCs intensified to that previously recommended.	
		3. Armed recon against LOCs plus strikes on infiltration corridors PUL.	
19 Feb 66	113-66	Repealed 18 Jan 66 recommendations and added that if these could not be implemented that the area of attacks be expanded to that which existed prior to the stand-down.	The ROLLING THUNDER decisions reached during the week of 10-16 Feb incorporated some of those recommendations on armed recon and the area was expanded on 1 Mar 66 to that it was prior to the stand-down.
20 Mar 66	189-66	To commence on 1 Apr 66:	Authorized:
		1. Controlled armed recon in HZ quadrant.	1. 1 Apr 66.
		2. Mine POL storage areas, 4 bridges, 1 cement plant, 1 steel mill, 1 thermal power plant, 1 SA/CCI radar site.	2. Four bridges, 4 POL sites, 1 POL tank plant, 1 truck park, and 1 motor repair facility on 31 May 66.
		3. No tactical restrictions to be placed on specific air strikes.	3. One bridge on 29 Jun 66.
		4. Authorized airtie to SPOD for Laos and North Vietnam.	4. Seven major POL and 1 bay CCI site on 29 Jun 66.
			5. Strikes were authorized to 10,000.
16 Apr 66	238-66	The ROLLING THUNDER Study Group Report recommended a plan of phased and selective air strikes on military targets and war supporting resources in North Vietnam to be conducted concurrently with an intensive armed reconnaissance program. It was developed in accordance with the recommendations of 18 Jan 66, above.	The concept and plan were noted by the Joint Chiefs of Staff and forwarded to the SECRETARY for information. No immediate military action developed.
9 May 66	295-66	Right of hot pursuit in Southeast Asia.	See 1 Jan 66 remarks.
27 Nov 66	777-66	Last stand-down to 48 hours with recon and conduct strikes against threatening military targets developing as a result of the stand-down.	Except for the TBT (142 hours) the stand-downs were held to 48 hours. No specific strike authorization in support of the recommendation developed.
27 Dec 66	792-66	JCS recommendations to SECRETARY for specific objectives for the air campaign in North Vietnam for 1967. (To be incorporated in a National Security Action Memorandum.)	NSA recommendations for this National Security Action Memorandum full meet of those of the Joint Chiefs of Staff.
18 Jan 67	75-67	Select military measures during TBT stand-down to provide early announcement of military posture.	TBT was instituted without implementation of recommendations.

22 Jan 64 JCSM-46-64: "Vietnam and Southeast Asia (U)"

Summary of Concept. The JCS informed SecDef that it was their view the United States must remove self-imposed restrictions and take stronger actions against NVN. "These restrictions while they may make our international position more readily defensible, all tend to make the task in Vietnam more complex, more time-consuming and, in the end, more costly." They recommended that the United States "make ready" to carry out, among others, the following actions: 1) overfly Laos and Cambodia to whatever extent necessary to acquire operational intelligence; 2) arm, equip, advise and support the GNV in its conduct of aerial bombing of critical targets in NVN and in mining the sea approaches to that country; 3) conduct aerial bombing of key NVN targets using US resources under VN cover, and with the GVN openly assuming responsibility for the bombings.

Remarks. This paper was furnished to the SecState by the SecDef. In his 5 Feb 64 reply to SecDef, the SecState stated that he shared the views of the JCS in "that the focus of the counter-insurgency battle lies in SVN itself." He further stated, "that this war, like other guerrilla wars, is essentially political--an important fact to bear in mind in determining command and control arrangements in Vietnam . . ., that we must determine what the effects will be on the other countries in the area of any major action we take . . .; that we must also determine with respect to any proposal action what we can realistically expect to achieve with that action, and balance that against the political and military risks attendant upon that action before reaching a decision."

2 Mar 64 JCSM-174-64: "Vietnam (U)"

Summary of Concepts. The JCS submitted preliminary judgements to SecDef designed to exert increasing military pressure upon the government of North Vietnam to cease support of the insurrection in South Vietnam and Pathet Lao activities in Laos. They stated that, after analyzing the enemy's strengths, capabilities and vulnerabilities, they arrived at the following conclusions:

a. US resolve and intentions to extend the war as necessary should be made clear immediately by overt military actions against the DRV.

b. Military action should be a part of a coordinated diplomatic, military, and psychological program directed at deterring the enemy and preparing the world for extension of the war.

c. Preparations should be made for military actions, one in the form of a sudden blow for shock effort, another in the form of ascending order of severity with increasing US participation, the purpose of either being to bring about cessation of DRV support of the insurgency.

d. It is unlikely that a graduated program of military operations against the DRV with increasing US participation will provoke large-scale Chinese Communist intervention.

e. Initial actions should provide for overt US demonstrations, expansion of RVN activities, including FARMGATE operations into the DRV.

f. Concurrently, preparations should be initiated for increasing the intensity of effort against the DRV by the US and GVN.

Remarks. In his memorandum dated 21 Feb 64, SecDef has requested these views of the JCS as to a number of military uncertainties that must be resolved. He wanted them

~~SECRET-SENSITIVE~~

for consideration before political decisions would be taken affecting a program, then being reviewed, designed to exert increasing military pressure upon the government of North Vietnam with a view to inducing that government to terminate its support and encouragement of the insurrection in South Vietnam and curtail Pathet Lao activities in Laos. SecDef appreciated the fact that a detailed response may have required a longer time, but requested a preliminary judgment for consideration prior to his anticipated departure for South Vietnam about 4 March 64.

In his 5 Mar 64 memorandum, SecDef stated: "Your comments and recommendations set forth in the references have been noted. They have been utilized by Assistant Secretary Bundy and Major General Anthis in their discussions in the Vietnam Coordinating Committee. The matters you raised will be reviewed with Admiral Felt and the Country Team in our forthcoming conferences."

~~SECRET-SENSITIVE~~

C-7

Appendix C

~~SECRET~~

14 Mar 64 JCSM-222-64: "Draft Memorandum for the President,"
Subject: "South Vietnam"

Summary of Concept. The JCS, after review of the draft memorandum proposed by the SecDef, concurred with its recommendations (listed below) subject to several comments including their conclusion that the recommended program to itself would not be sufficient to turn the tide against the Viet Cong in South Vietnam without positive action being taken against the Hanoi Government at an early date. They re-emphasized the program outlined in JCSM-174-64 of 2 Mar 64, subject: "Vietnam." (See above)

Recommendations.

"1. To make it clear that we are prepared to furnish assistance and support to South Vietnam for as long as it takes to bring the insurgency under control.

"2. To make it clear that we fully support the Khanh government and are opposed to any further coups.

"3. To support a Program for National Mobilization (including a national service law) to put South Vietnam on a war footing.

"4. To assist the Vietnamese to increase the armed forces (regular plus paramilitary) by at least 50,000 men.

"5. To assist the Vietnamese to create a greatly enlarged Civil Administrative Corps for work at province, district and hamlet levels.

"6. To assist the Vietnamese to improve and reorganize the paramilitary forces and to increase their compensation.

"7. To assist the Vietnamese to create an offensive guerrilla force.

"8. To provide the Vietnamese Air Force 25 A-1H aircraft in exchange for the present T-28s.

~~SECRET~~

~~SECRET~~

"9. To provide the Vietnamese Army additional M-113 armored personnel carriers (withdrawing the M-114s there), additional river boats, and approximately \$5-10 million of other additional material.

"10. To announce publicly the Fertilizer Program and to expand it with a view within two years to trebling the amount of fertilizer made available.

"11. To authorize continued high-level US overflights of South Vietnam's borders and to authorize "hot pursuit" and South Vietnamese ground operations over the Laotian line for the purpose of border control. More ambitious operations into Laos involving units beyond battalion size should be authorized only with the approval of Souvanna Phouma. Operations across the Cambodian border should depend on the state of relations with Cambodia.

"12. To prepare immediately to be in a position on 72 hours' notice to initiate the full range of Laotian and Cambodian "border Control" actions (beyond those authorized in paragraph 11 above) and the "Retaliatory Actions" against North Vietnam, and to be in a position on 30 days' notice to initiate the program of "Graduated Overt Military Pressure" against North Vietnam."

Remarks. The 13 Mar 64 Draft Memorandum was sent in final form to the President on 16 Mar 64, and approved by the President in a meeting of the National Security Council on 17 Mar 64. All agencies concerned were directed to proceed energetically with the execution of the recommendations of that National Security Action Memorandum (NSAM 288). In a subsequent memorandum (JCSM-256-64) the JCS recommended that SecDef bolster the sagging program and "take the lead in energizing the actions which must be taken throughout the government."

~~SECRET~~

7 Jun 64 JCSM-471-64, subject: "Objectives and Courses of Action-Southeast Asia (U)" and CM-1451-64, subject: Comments of the Chairman, Joint Chiefs of Staff, on JCSM-471-64

Summary of Concept. This JCSM, which was an agreed JCS paper, less the views of the Chairman, Joint Chiefs of Staff, recommended the following:

a. That in any national level discussions of action against North Vietnam, precise delineations of both objectives and their supporting courses of action be sought.

b. That the United States prepare to accomplish through military actions, destruction of the North Vietnamese will and capabilities as necessary to counsel the Democratic Government of Vietnam (DRV) to cease providing support to the insurgencies in South Vietnam and Laos.

c. That, as a lesser alternative, the employment of limited military action against two target complexes (Vinh and Dien Bien Phu) be geared to demonstrating an early, sharp change in US outlook and determination.

A subsequent memorandum by the Chairman (CM-1451-64) dated 5 June 1964, added a third pattern from among which the choice could be made to initiate the attack on North Vietnam. This was a compromise between the JCS all-out and demonstrative attacks. It was the recommendation of the Chairman; however, he also recommended, since he felt that it was highly probable that political considerations would incline the responsible civilian officials to ask for the demonstrative attacks, that the JCS be asked to develop a strike plan based on such a decision.

Remarks. In his 10 June 1964 memorandum to the CJCS "that the Joint Chiefs of Staff be asked to develop a strike plan based upon demonstrative strikes against limited military targets." The first reprisal attacks were executed on 5 Aug 64 and 8-11 Feb 65.

~~SECRET~~

5 Jun 64 JCSM-489-64, subject: "Initial Low-Level
Reconnaissance Operation into North Vietnam"

Summary of Concept. This paper recommends that high priority, low-level reconnaissance over North Vietnam be conducted as soon as possible at maximum effort. Maximum effort is defined as 22 initial daylight sorties over five key routes feeding into Laos followed by repetitive coverage to maintain meaningful surveillance of supply and infiltration activity along these routes. It also includes night photography of selected targets on an infrequent basis.

Remarks. SecDef noted the JCS recommendation in his 15 Jun 1964 memorandum and directed that the plan be kept in readiness to be carried out on short notice. After subsequent recommendations low level reconnaissance over NVN was initiated on 10 Mar 65.

~~SECRET~~

C-11

Appendix C

~~SECRET~~

24 Aug 64 JCSM -729-64: "Target Study - NVN (S)"

Summary of Concept. The JCS provided SecDef with a list of targets "considered most critical to the DRV support of insurgency operations, DRV military capabilities, and industrial output. The purpose of air attacks against these targets would be to cause the DRV to desist from supporting the Pathet Lao (PL) and Viet Cong (VC) and to reduce the will and capability of that Government to renew any such support." Targets were grouped into five basic categories:

Category A - Airfields.

Category B - Lines of communications (bridges, railroad yards, and shops).

Category C - Military Installations (military barracks/headquarters, ammunition depots, POL storage, supply depots, communications facilities, and port facilities).

Category D - Industrial Installations.

Category E - Route Armed Reconnaissance.

The JCS stated that CINCPAC had been directed to develop and submit strike plans for four patterns of attack in ascending order of severity against NVN. They indicated that if the decision was made to strike a major blow against NVN, time could be reduced "by deploying additional tactical fighter squadrons (US Air Force and US Marine Corps) and an additional CVA group" and utilizing SAC forces listed in the JSCP for contingency plans.

From a military viewpoint, the JCS considered "that the most effective application of military force will result from a sudden sharp blow in order to bring home the penalties for violating international agreements and the intent of the United States to bring a cessation of DRV support of the insurgency in Laos and the RVN."

The JCS pointed out that where feasible, leaflet missions could be flown to warn civilians.

~~SECRET~~

C-12

Appendix C

~~SECRET~~

Remarks. On 31 August 1964, SecDef acknowledged receipt of the Target Study and posed questions on the following:

a. The sufficiency of ordnance and POL stocks in PACOM to deal with the upper scale of action within the DRV/CHICOM capability, after conducting a full-scale air campaign against the military and industrial targets in NVN.

b. The economic and military effect upon NVN of various patterns of air strikes.

c. Courses of action to be taken if the objective of air attacks against the DRV will and capability were not attained.

The JCS provided answers (JCSM-934-64) of Nov 64 to SecDef's questions as follows:

a. A preliminary estimate indicated sufficient ordnance and POL stocks would be available to initiate upper scale actions with support until resupply would be effected. A follow-on memorandum (JCSM-955-64; summarized below) would give more precise answers.

b. The capability of the DRV to provide material to the PL and VC at present levels would be reduced by air strikes against the targets in NVN. Should there be a significant increase in present levels of support, air strikes would have a greater effect of DRV capability to support, and as the level and intensity of air strikes are increased, they would significantly reduce DRV capability to support large-scale military aggression against Laos or RVN.

c. Additional actions that could be taken include restrikes, striking new targets, naval actions, unconventional and psychological operations, extension of armed recce, amphibious/airborne lodgements in DRV, and assuming a strategic posture in Southeast Asia to deter enemy reaction and to ensure readiness for escalation.

~~SECRET~~

Subsequently attacks were made on a limited number of targets of the five classes as follows:

- a. Airfields 30 Apr 65 (RT 13)
- b. LOC Interdiction 2 Apr 65 (RT 9)
- c. Military Facility 2 May 65 (RT 5)
- d. Industrial Facility 30 Apr 65 (RT 13)
- e. Armed Reconnaissance 19 Mar 65 (RT 7)

26 August 1964 JCSM-746-64, subject: "Recommended Courses of Action - Southeast Asia." (U)

Summary of Concept. This memorandum was developed with consideration for the reviews of CINCPAC and Ambassadors Taylor and Unger on objectives and courses of action in Southeast Asia. The DIA assessment (7 August 1964) of Asian communist capabilities and probable courses of action following the 5 August retaliatory attack on North Vietnam was also considered. In recommending courses of action for increased pressures on NVN, the JCS indicated that more direct and forceful military actions would be required, including "air strikes and other operations against appropriate military targets in the DRV." The JCS advocated the immediate adoption and implementation of such a program which might be purely VNAF; VNAF with US escort to provide protection from possible employment of MIGs; VNAF with US support in the offensive as well as the defensive role; or entirely US. The precise combination to be determined by the effect we wish to produce and the assets available.

Remarks. On 25 August 1964, General Khanh, under pressure, resigned as President of the RVN. The JCS considered the situation as critical and demanding of increased actions against North Vietnam to provide the relief and psychological boost necessary for attainment of the requisite governmental stability and viability. The Assistant SecDef (ISA) stated in his 28 August 1964 memorandum (I-36588/64) that the JCS recommendations for future courses of action in Southeast Asia will be carefully considered in the then current interdepartmental policy discussions and in forthcoming conferences with Ambassador Taylor. In addition, the Department of State was provided a copy of the JCSM. No other action occurred.

07 Oct 64 JCSM-902-64: "Courses of Action, Southeast Asia (U)"

Summary of Concept. In this memorandum to SecDef, the JCS proposed courses of action in support of a new military-political program" on the basis that US withdrawal from the RVN or Southeast Asia is not now an acceptable course of action." The JCS believed that "strong military actions are required now in order to prevent the collapse of the US position in Southeast Asia."

Some of these courses were air actions against the DRV. Their implementation was recommended to the "extent necessary to cause the DRV to cease support and direction of the insurgency." They are:

1. "Appropriate retaliatory actions to DRV/VC initiations."
2. "Low-level reconnaissance probes of the DRV."
3. "Attack LOC in DRV in conjunction with air strike operations on nearby targets in RVN and Laos."
4. "Air strikes against infiltration associated targets in DRV."
5. "Aerial mining of DRV ports" at Haiphong and Cam Pha.
6. "Naval quarantine/blockade of the DRV (also applies to Cambodia)".
7. "Attacks with increasing severity, targets in DRV."
8. "All-out air attack on the DRV."
9. "Amphibious/airborne operations on the coastal areas in DRV" to seize one or more lodgements.

Specifically, the JCS recommended immediate implementation of items 1, 2, and 3 with the remainder being subsequently implemented "as required to achieve US objectives in Southeast Asia."

Remarks. On 29 October 1964, the SecDef, in a memorandum to the CJCS, stated that he noted the recommendations of the JCS and that they were given to the Department of State. He further stated that Ambassador Taylor's views would have to be quickly obtained "with respect to the specific JCS recommendations and their timing" so that his comments and those of the JCS could "be presented to the President very soon." No immediate action developed; however, reprisal strikes were executed in Feb 65 and the ROLLING THUNDER program, which was instituted in Mar 65, relate to recommendation 2., 3., and 4.

~~SECRET~~

4 Nov 64 JCSM-933-64: "Recommended US Courses of Action in Relation to Viet Cong Attack on Bien Hoa Airfield, 1 November 1964 (S)"

Summary of Concept. In response to the VC attack on US forces at Bien Hoa airfield, the JCS informed SecDef that this attack was "a deliberate act of escalation and a change of ground rules under which the VC have operated up to now." The JCS stated that the time was "appropriate to undertake US military action to cause the Democratic Republic of Vietnam (DRV) to desist from their support of the Viet Cong/Pathet Lao (VC/PL) insurgencies," and they confirmed their oral recommendations of 1 November for such action. The JCS recommended a program of specific actions, including the following air operations against North Vietnam:

1. "Conduct low-level air reconnaissance of infiltration routes and of targets in North Vietnam south of Latitude 19 degrees."

2. "Assemble and prepare necessary forces so that:

(a) Within 60 to 72 hours, 30 B-52s from Guam conduct a night strike on DRV target #6 (Phuc Yen airfield).

(b) Commencing at first light on the day following subparagraph (a) above, PACOM air and naval forces conduct air strikes against DRV targets #6 (Phuc Yen airfield) (daylight follow-up on the above night strike), #3 (Hanoi Gia Lam airfield), #8 (Haiphong Cat Bi airfield), #48 (Haiphong POL), and #49 (Hanoi POL).

(c) Concurrently with subparagraph (b) above, the Vietnamese Air Force (VNAF) will strike DRV target #36 (Vit Thu Lu barracks).

(d) Combat air patrols (CAP), flak suppressive fire, strike photographic reconnaissance, and search and rescue operations (SAR) are conducted as appropriate.

~~SECRET~~

C-18

Appendix ~~5~~

~~SECRET~~

(e) The above actions are followed by:

(1) Air strikes against infiltration routes and targets in the DRV.

(2) Progressive PACOM and SAC strikes against the targets listed in the 94 Target Study."

The JCS elaborated on these actions as follows:

"The night B-52 strikes on Phuc Yen airfield as the first major military response is designed to destroy a major component of present and potential DRV air capability, by use of an all-weather system. The specific strikes recommended for PACOM forces during the next daylight will destroy additional DRV capabilities, including facilities otherwise available for CHICOM re-inforcing actions, and set the stage for the follow-on US and VNAF operations. The recommended VNAF strike provides GVN participation and is within VNAF capability."

Remarks. The SecDef (Memorandum of 13 Nov 64) provided a copy of the JCSM to the Department of State and stated that the views of the JCS were "being carefully considered in the current interdepartmental deliberations concerning our future courses of action in Southeast Asia." No immediate action developed; however, low-level reconnaissance was instituted on 10 Mar 65 and the ROLLING THUNDER program, which started in Mar 65, attacked a limited number of the less important targets.

~~SECRET~~

~~SECRET~~

14 Nov 1964 JCSM-955-64: "Courses of Action in Southeast Asia (U)"

Summary of Concept. At a White House meeting on 2 Nov 64, the JCS were requested to examine the possible military reactions of the DRV/CHICOM to US military strikes against NVN. As a result, the JCS gave SecDef an analysis of "the threat and possible enemy reactions, our response to such reactions, and the preparatory measures which we should undertake prior to mounting an attack so that we could defer a CHICOM response or, failing that, respond in a timely effective fashion to any enemy initiative... The underlying objective remains that of causing the DRV to cease supporting and directing the insurgencies in RVN and Laos."

The JCS repeated their recommendations of 4 Nov 64 in relation to the attack on Bien Hoa airfield, stating that these recommendations "comprise an option equally applicable and available for immediate implementation in the event of other serious provocations in Southeast Asia." After analyzing enemy courses of action, the JCS concluded that "Direct CHICOM military intervention would call for US military operations against mainland China."

Remarks. In his 17 Nov 64 memorandum, the SecDef noted the views of the JCS, stated that the Department of State had received a copy for incorporation of the views of the JCS in the Joint State - Defense report being prepared, and that the views of the JCS would be presented to the President concurrently with the Joint State-Defense report. No immediate military action resulted; however, see previous remarks.

~~SECRET~~

C-20

Appendix ~~SECRET~~

~~SECRET~~

18 Nov 64 JCSM-967-64: "Courses of Action in Southeast Asia (U)"

Summary of Concept. As a result of a SecDef conversation with the CJCS on 10 Nov 64 concerning "a possible US program of actions in Southeast Asia comprising a controlled program of systematically increased military pressures against the Democratic Republic of Vietnam (DRV) applied in coordination with appropriate political pressures," the JCS told SecDef "It is desirable that a clear set of military objectives be agreed upon before further military involvement in Southeast Asia is undertaken." They pointed out that their memorandum of 14 November (JCSM-955-64) set forth "their preferred courses of action to reverse the unfavorable trend in the Republic of Vietnam (RVN) and Laos with the objective of causing the DRV to cease supporting and directing the insurgencies in those countries. If a controlled program of systematically increased pressures was directed, the JCS recommended that the following objectives were appropriate:

"a. Signal the willingness and determination of the United States to employ increasing force in support of national objectives with respect to RVN and Laos; namely, an independent and stable non-communist government in RVN and a free and neutral Laos under the terms of the Geneva Accords of 1962.

"b. Reduce, progressively, DRV support of the insurgencies in RVN and Laos to the extent necessary to tip the balance clearly in favor of the Governments of RVN and Laos by:

(1) Reduction of the amount of support available through destruction of men, material, and supporting facilities;

(2) Reduction of the amount of support available through diversion of DRV resources to increased homeland defenses and alerts; and

~~SECRET~~

(3) Reduction of the rate of delivery of the available support through destruction of bridges and other LOC choke points; staging facilities and transport; and through interruption of movements by attacks on selected fixed targets, armed route reconnaissance, raids, and waterborne interdictions.

"c. Punish the DRV for DRV-supported military actions by the Viet Cong/Pathet Lao (VC/PL) against the Governments of RVN and Laos, including the US casualties which have resulted from those actions.

"d. Terminate the conflicts in Laos and RVN only under conditions which would result in the achievement of US objectives."

The JCS also recommended a controlled program of "systematically increased" military pressures against North Vietnam, consisting of "sequential actions," "reprisal actions," and "collateral actions." The sequential actions included the following air operations against North Vietnam:

"Conduct low-level reconnaissance probes of infiltration associated targets near the Laos border in the DRV and attack LOC in DRV near the Laos border and the DMZ.

"Expand the reconnaissance coverage of the DRV with extension to Cambodia if necessary, and conduct air strikes against infiltration-associated targets in the DRV (Phase I - 13 targets south of the 19th parallel, followed by Phase II - 14 targets north of the 19th parallel).

"Conduct aerial mining of DRV ports, initiate a naval quarantine/blockade of the DRV, and attack, with increasing severity, targets in the DRV.

"Conduct air strikes against remaining military and industrial targets in the DRV. Targets are as contained in '94 Target' list (JCSM-729-64)."

~~SECRET~~

The reprisal actions included those actions already recommended by the JCS on 4 and 14 November. The collateral actions provided for deployments to support the above actions.

Remarks. The SecDef, in memorandum on 21 Nov 64, noted the views of the JCS and stated that the JCSM was sent to the Department of State to be included along with JCSM-955-64 in interdepartmental studies of the subject. No immediate action developed; however, see 4 Nov 64 remarks. In a subsequent memorandum (JCSM 1005-64 of 1 Dec 1964) the JCS stated that this program of systematically increased pressures should be implemented about 15 December 1964 and completed in two to three months; however, the program has been extended over two years during which time some actions have not yet been taken.

~~SECRET~~

22 Nov 64 JCSM-982-64: "Courses of Action in Southeast Asia (U)"

Summary of Concept. The JCS, commenting on a draft of "Courses of Action in Southeast Asia" prepared by the National Security Council Working Group, stated to SecDef that they "understand established national policies include as objectives in Southeast Asia a stable and independent noncommunist government in the Republic of South Vietnam (NSAM 288 of 17 Mar 64), and a stabilized situation in Laos which conforms to the Geneva Accords of 1962 (NSAM 249, 25 Jun 63). They consider these objectives to be valid and essential to maintaining the US security position world-wide. They further consider that the best probability of success in attaining these ends will be afforded by achieving the prerequisite objective of causing the cessation of North Vietnamese (DRV) support and direction of the insurgencies in RVN and Laos. Early implementation of political and military actions designed to achieve these objectives, in addition to continued aggressive programs in SVN, offers the greatest assurance of success."

The JCS examined five courses of action open to the US in Southeast Asia, and recommended the implementation of the following course of action as offering the "best probability of attaining the stated objectives."

"Undertake a controlled program of intense military pressures against the DRV, swiftly yet deliberately applied, designed to have major military and psychological impact from the outset, and accompanied by appropriate political pressures. The program would be undertaken on the basis that it would be carried through, if necessary, to the full limits of what military actions can contribute toward US national objectives; it would be designed, however, for suspension short of those limits if objectives were earlier achieved. The military program for this course of action is the program recommended in JCSM-955-64, dated 14 November 1964."

~~SECRET-SENSITIVE~~

Remarks. The SecDef acknowledged receipt of the JCSM on 30 Nov 64 and stated that it had been provided to the Department of State for utilization by the National Security Council Working Group (NSCWG). No immediate action developed; however, see 18 Nov 64 remarks.

~~SECRET-SENSITIVE~~

C-25

Appendix C

~~SECRET~~

7 Dec 1964 JCSM-1076-64: "Recommended Reprisal
Action in Retaliation to Brink BOQ Incident (TS)"

Summary of Concept. Considering that the bombing of the
Brink BOQ was "a deliberate act aimed directly at US
forces in South Vietnam," the JCS recommended "that a
reprisal attack be executed immediately on DRV Target
Number 36, Vit Thu Lu Army barracks," with the attack
primarily "a US operation."

Remarks. This action was disapproved by "highest levels"
by message (SEC STATE Washington, D. C. 292253 Z Dec).

~~SECRET~~

C-26

Appendix ~~9~~

11 Feb 1965 JCSM-100-65: "Courses of Action-Southeast Asia - First Eight Weeks (S)"

Summary of Concept. The JCS recommended an "eight weeks program of attacks against DRV targets." The program, "primarily a plan for air strikes," would be confined generally to "targets along Route 7 and south of the 19th parallel, "and employ "both RVN and US forces." It was anticipated that "initial overt air strikes" would be as "retaliation in response to a provocative act by Viet Cong or DRV forces against US or RVN personnel or installations" and that "successive overt operations to provide sustained pressures and progressive destruction will be continued on the plausible justification of further provocations, which on the basis of recent past experience seem quite likely to exist." The JCS believed that "as the program continues the realistic need for precise event-association in this reprisal context will progressively diminish." They anticipated that such a program would bring about response from NVN, Communist China and the Soviet Union varying from the use of propaganda, to defense, to overt aggression in SVN, though the JCS believed that the Chinese Communists "would be reluctant to become directly involved in the fighting in Southeast Asia." The JCS also considered "that the probable Soviet response . . . would consist both of a vigorous diplomatic and propaganda effort to bring the United States to the conference table and the provision of military support to North Vietnam."

It was the opinion of the JCS that this program would demonstrate to the DRV that continuation of its direction and support of insurgencies would lead progressively to more serious punishment. If the insurgencies were to continue, with active DRV support, strikes against the DRV would be extended with intensified efforts against targets north of the 19th parallel.

Remarks. The program as recommended by the JCS was not favorably acted upon. The targets eventually were struck as a result of subsequent recommendations. This program was recommended by the JCS after it became apparent that none of their previous recommended programs would be adopted. It is significantly reduced in scope and intensity from previously recommended programs.

27 May 1965 JCSM-415-65: "Air Operations against North Vietnam (U)"

Summary of Concept. The JCS informed SecDef that they considered "that the introduction of an offensive bomber (IL-28) capability into North Vietnam adds a new dimension to the situation in Southeast Asia for it gives the DRV a markedly greater capability to undertake offensive air action against US forces and against all targets in the Republic of Vietnam." They added: "Although the offensive bomber aircraft introduced are few in number, the threat they pose is significant when the potential targets, such as the airfield at Da Nang, are considered."

On 19 April, SecDef had expressed the desire that he be kept informed "of the readiness status of the surface-to-air missile (SAM) site 15 miles southeast of Hanoi." The JCS provided him with the following information:

"Within this past week, this site has attained a state of readiness whereby it can become operation at any time. If not neutralized, this SAM site, estimated to be the first of four-five (three sites are now identified) in an arc protecting the Hanoi-Haiphong complex, will become a threat to ROLLING THUNDER and US reconnaissance operations. The arc, if completed, would pose a serious threat to all air operations in an area approximately 80 x 125 miles around Hanoi . . ."

The JCS considered "the neutralization and elimination of the IL-28/MIG threat and the SAM site to be a matter of military urgency." They had considered the "political factors and policy considerations which might weigh against the US course of action discussed herein." They believed "that in this instance, military considerations are clearly overriding and that the proposed air operations against the IL-28/MIG threat and the SAM site should be approved now in order to permit timely action." The JCS recommended that SecDef approve a message which would authorize CINCPAC and CINCSAC to conduct attacks to:

- a. Neutralize/eliminate the Phuc Yen IL-28/MIG threat.
- b. Destroy the SA-2 site SE of Hanoi.
- c. Destroy any military aircraft which may have deployed to **other** airfields in NVN as well as POL storage associated with the major jet capable airfields in the Hanoi/Haiphong area."

Remarks. The JCSM, recommendations, which were brought to the attention of the President, were disapproved by the SecDef by memorandum on 15 Jun 65 for the following reasons:

- a. Ambassador Johnson, with General Westmoreland's concurrence, recommended against it.
- b. The Intelligence community estimates indicated that it was unlikely that the enemy would employ the IL-28s in offensive actions.
- c. The Hanoi SA-2 sites had not yet interfered with the air campaign.

On 21 Jun 65, the JCS, after review of the 15 Jun 65 SecDef memorandum, agreed to the preparation of a response-type paper (JCSM-498-65 below).

The only military action which developed from these recommendations occurred after the 24 Jul 65 shutdown of an F-4C by a SAM - the SA-2 sites were authorized for a special strike on 27 Jul 65.

~~SECRET~~

11 Jun 65 JCSM-457-65: "US/Allied Troop Deployments
To South Vietnam (SVN)(S)"

Summary of Concept. The JCS reaffirmed their recommendations of 27 May 65 (JCSM-415-65 above), recommended increased deployments and further stated that in addition to the subject deployments, the Joint Chiefs of Staff considered that air action against North Vietnam should have been intensified to include increased armed reconnaissance of LOCs and strikes against militarily important targets. Such action, they said, was necessary to reduce DRV capabilities to support the VC and the PAVN to punish the DRV, and to further establish US intent to prevent a communist seizure of SVN.

Remarks. No immediate military actions along the lines of these recommendations against NVN developed.

~~SECRET~~

C-31

Appendix C

26 Jun 65 JCSM-498-65: "Air Actions Against North Vietnam (U)"

Summary of Concept. The Joint Chiefs of Staff carefully considered the military threat created by the SAM sites/MIGs/IL-28s and re-evaluated the political and military risks involved both in attacking and in not attacking them. They concluded that the threat to our forces was such that the risks attendant upon positive action had to be accepted. The Joint Chiefs of Staff reiterated their concern that failure to take timely action against a known threat would be difficult indeed to explain were the enemy to launch successful air operations from his then present posture. From a military point of view, it would have been desirable to eliminate both the SAM sites and the hostile air threat concurrently. If this course of action was politically unacceptable, the Joint Chiefs of Staff recommended destruction of the SAM sites as they neared operational status in order to permit greater freedom of target destruction and high-level reconnaissance in the Hanoi area.

Remarks. SecDef met with the JCS on this paper on 28 June. The JCS were asked to provide answers to questions posed regarding expected attrition; that is, comparative costs, attrition rates and alternatives with supporting rationale. These were provided on 3 Jul 65.

The 24 July 65, an F-4C and crew were lost and three additional F-4Cs in the flight suffered major damage from one or more SAM sites.

The JCS directed CINCPAC to attack the two suspected SAM sites on 27 Jul 1965 and on 11 Aug 65 authorized armed reconnaissance attacks to seek out and destroy sites within the recce area.

On 12 August 1965, however, the Joint Chiefs of Staff were notified that their over-all recommendations would not be favorable acted upon.

~~SECRET~~

6 Aug 65 JCSM-608-65: "Blockade and Aerial Mining Study (U)"

Summary of Concept. This study, made in response to National Security Action Memorandum (NSAM 328), states that "effective maritime control measures, if accompanied by sustained air interdiction, thus appear to afford a significant means of applying pressure across the board against DRV LOCs . . . which contribute to the capability of the DRV to support the Viet Cong insurgency in South Vietnam." The JCS recommended "aerial mining of the approaches to the ports of Haiphong, Han Gay, and Cam Phu in the DRV" with minor ports added as required. They recommended complementary increased interdiction against high density LOCs north of the 20th parallel.

Remarks. The DEPSECDEF, stated in his 18 Aug 65 memo, that the study was given to the Department of State for political assessment and would, thereafter, receive consideration for future military action. The first river mining action occurred 12 March 1967.

~~SECRET~~

C-33

Appendix C

~~SECRET~~

27 Aug 65 JCSM-652-65: "Concept for Vietnam (U)"

Summary of Concept. To support the national objective in Vietnam (NSAM-288) of securing a "stable and independent noncommunist government; the JCS recommended the following US basic strategy: intensify military pressure on the DRV by air and naval power; destroy significant DRV military targets, including the base of supplies; interdict supporting LOCs in the DRV; interdict supporting LOCs in the RVN; interdict the infiltration and supply routes into the RVN; improve the combat effectiveness of the RVNAF; build and protect bases; reduce enemy reinforcements; defeat the Viet Cong, in concert with RVN and third country forces; and maintain adequate forces in the Western Pacific and elsewhere in readiness to deter and to deal with CHICOM aggression. By aggressive and sustained exploitation of superior military forces, the United States/Government of Vietnam would seize and hold the initiative in both the DRV and RVN, keeping the DRV, the Viet Cong, and the PL/VM at a disadvantage, progressively destroying the DRV war-supporting power and defeating the Viet Cong. The physical capability of the DRV to move men and supplies through the Lao Corridor, down the coastline, across the DMZ, and through Cambodia must be reduced to the maximum practical extent by land, naval, and air actions in these areas and against infiltration-connected targets. Finally, included within the basic US military strategy must be a buildup in Thailand to ensure attainment of the proper US-Thai posture to deter CHICOM aggression and to facilitate placing US forces in an advantageous logistic position if such aggression occurs.

Remarks. On 11 Sep 65, the SecDef acknowledged receipt of, and agreement with, the "Concept for Vietnam" and stated further agreement "that recommendations for future operations in SEA should be formulated" and submitted for individual consideration as they are developed. He sent a copy of the memorandum to the Department of State and the White House for use in future deliberations. No immediate military action over and above the ROLLING THUNDER program developed.

~~SECRET~~

C-34

Append

~~SECRET~~

2 Sep 65 JCSM-670-65: "Air Strikes Against North Vietnam (U)"

Summary of Concept. The JCS recommended a program of air strikes to be undertaken as a matter of urgency, giving military reasons why the program should be initiated; and setting forth a concept of operations. Targets included:

"a. The Phuc Yen Airfield installation, including the aircraft thereon.

b. The rail, highway, and waterway routes and traffic between Hanoi and Haiphong.

c. The rail, highway, and waterway routes and traffic between Hanoi-Haiphong and south China.

d. POL storage facilities at Haiphong.

e. Those SAM installations and other anti-aircraft defenses which pose a threat to the above air operations."

The JCS stated that:

"Failure to initiate air operations against North Vietnam now as recommended herein to support the overall strategy for Southeast Asia would result in increased US commitments, costs, and casualties and increasing risk to the security of major elements of US and SVN military forces and facilities. Each day's delay produces increased enemy capability which will have to be destroyed eventually at an increasingly higher cost to the United States."

The JCS requested "that their views be brought to the attention of the President without delay."

Remarks. The DEPSECDEF, on 4 Sep 65, posed questions to the JCS regarding the US preparations, ability to, and anticipation of a NVN strike against US/SVN forces. He also asked if the JCS thought it advisable to seek the views of the Board of National Estimates or the judgment of Ambassador Taylor and General Westmoreland prior to the rendering of decisions on this paper. The answers were submitted on 11 Sep 65 (JCSM-686-65 below).

~~SECRET~~

~~SECRET~~

Authorization to strike from Phuoc-Yen airfield has not yet been granted; however, in the NE area, the LOCs were initially attacked on 17 Sep 65, some SAM sites 1 Oct 65, and parts of the major POL on 29 Jun 66.

~~SECRET~~

C-36

Appendix ~~SECRET~~

~~SECRET~~

11 Sep 65 JCSM-666-65: "Air Strikes Against North Vietnam - JCSM-670-65 (U)"

Summary of Concept. The JCS answered questions posed by DEPSECDEF about their recommended program of air strikes of 2 September 1965. They reiterated the urgent military necessity for the program, in view of the importance of this matter to the conduct of the war, minimizing the risk to major forces and facilities and preventing casualties. The JCS reiterated their recommendation that these proposed air strikes be authorized now for immediate execution.

Remarks. By memorandum, on 15 Sep 65, the SecDef informed the JCS that he was "not persuaded by the reasoning of JCSM 670-65 that the military advantages the Joint Chiefs of Staff state would flow from the proposed strike effort outweigh the military and political risks involved in implementing the proposal." He added that a "new up-to-date Special National Intelligence Estimate" would be obtained to determine the likely DRV, Chinese and Soviet military reactions to a program of the magnitude, timing and scope recommended by the JCS. This estimate would also evaluate the effect of the strike program on the effort within South Vietnam.

In addition, he stated that the JCS "should make recommendations with respect to any further intensification of air defense and early warning capability required to properly defend South Vietnam and our forces there."

See previous remarks re military actions in response to the recommendations.

~~SECRET~~

~~SECRET~~

1 Jan 66 JCSM-8-66: "JCS Basic Rules of Engagement - Southeast Asia (U)"

Summary of Concept. The JCS submitted revised rules of engagement for SE Asia in order to provide clear, concise regulations which could be observed by engaged forces with minimum likelihood of mistakes through misunderstandings and misinterpretations. Among other changes, the JCS proposed a revision of the definitions of "hostile aircraft" to include "hostile aircraft as may be encountered over Cambodia," and a provision for "immediate pursuit of hostile forces in/over Southeast Asia." Authorization for pursuit into Cambodian territory, seas and air spaces did not include authority "to attack Cambodian forces, except in self-defense," or "to conduct air or artillery operations against populated Cambodian areas." The JCS proposed removing the restriction against pursuit into CHICOM air space and seas, stating:

"The removal of this restriction is considered essential at this time in light of the increasing CHICOM MIG threat in order for our forces to exercise their legitimate right of self-defense. Provisions also are required now for the likelihood that other hostile air forces will utilize CHICOM bases as a sanctuary."

Remarks. See remarks associated with JCSM-295-66 below dated 9 May 66.

~~SECRET~~

C-38

Appendix

~~SECRET~~

8 Jan 66 JCSM-16-66: "Air Operations Against North Vietnam (U)"

Summary of Concept. The JCS informed SecDef that air strikes against NVN were "an essential complement to US/Free World military operations in South Vietnam" and that the direct pressure of these air strikes was "a principal means of persuading the DRV to cease its support and direction of the insurgency in SVN." They added that "the present stand-down contravenes that purpose and greatly weakens US negotiating leverage." The JCS recognized "the merits of peace offensives, especially with respect to their impact on US and world opinion," but stated that experience "cautions against the substantial risk in an all-out effort for negotiation during a stand-down." They added:

"The Joint Chiefs of Staff consider the early resumption of offensive air operations essential if we are to avoid a misinterpretation of US resolve in Southeast Asia, redress advantages accruing to the DRV from the stand-down; and enter into meaningful negotiations from a position of strength. The Joint Chiefs of Staff therefore recommend that a policy decision be taken now to terminate the stand-down of offensive air operations against the DRV 48 hours subsequent to Shelepin's return to Moscow from Hanoi, by which time the Soviets would have had opportunity to communicate to us any substantive results of his visit."

Remarks. SecDef acknowledged receipt of the JCSM on 19 Jan 66 and stated that a copy had been forwarded to the SecState. Air operations were resumed against North Vietnam on 31 Jan 66.

~~SECRET~~

~~SECRET~~

18 Jan 66 JCSM-41-66: "Air Operations Against North Vietnam (NVN) (U)"

Summary of Concerns. After a review of the air strike program against NVN, the JCS informed SecDef that the restrained air strikes against the north, "as conducted thus far," would not achieve the primary military objective of causing NVN to cease its support and direction of aggression in RVN. They stated that the piecemeal nature of the attacks against NVN had permitted the enemy "greater freedom to replenish and disperse his stocks, redirect the flow of materials and improve his defenses." The geographic restrictions and limitation on the number of armed reconnaissance sorties authorized had limited effective interdiction of the extensive rail, highway, and inland waterway LOCs. Moreover, these restrictions and the requirement for single coordinated attacks on specified targets had exposed US forces to greater risks. The JCS considered that "offensive air operations against NVN should be resumed now with a sharp blow and thereafter maintained with uninterrupted, increasing pressure These operations should be conducted in such a manner and be of sufficient magnitude to: deny the DRV large-scale external assistance; destroy those resources already in NVN which contribute most to the support of aggression; destroy or deny use of railway facilities; and harass, disrupt, and impede the movement of men and materials into SVN." Therefore, the JCS recommended that:

"a. The authorized area for offensive air operations be expanded to include all of NVN less the area encompassed by a ten-mile radius around Hanoi/Phue Yen Airfield, a four-mile radius around Haiphong and a twenty-mile China buffer zone. Exceptions to permit selected strikes within these restricted areas, in accordance with the air campaign described herein, will be conducted only as authorized by the Joint Chiefs of Staff.

"b. Numerical sortie limitations on armed reconnaissance in NVN be removed.

"c. No tactical restrictions or limitations be imposed upon the execution of the specific air strikes.

~~SECRET~~

C-40

Appendix C

~~SECRET~~

"d. The Joint Chiefs of Staff be authorized to direct CINCPAC to conduct an air campaign against the DRV as described herein."

Remarks. On 22 Jan 66, SecDef suggested in a memorandum to the CJCS that the JCS "undertake to secure an inter-agency intelligence assessment of the probable effects" of the adoption of their recommendations "on NVN capability to support the insurgency in SVN." This was referred to the DIA on 25 Jan 66. DIA made a request for a Special National Intelligence Estimate (SNIE) on 27 Jan 66. The United States Intelligence Board approved the SNIE on 4 Feb 66 and the JCS received it on 5 Feb 66. While the air campaign was resumed on 31 Jan 66, military action in support of the recommendations did not develop.

~~SECRET~~

C-41

Appendix C

~~SECRET~~

25 Jan 66 JCSM-56-66: "Air Operations Against North Vietnam (NVN) (U)"

Summary of Concept. The JCS forwarded to SecDef three alternatives for the initiation of the program of offensive air operations against NVN which they had recommended on 18 January 1966. The three alternatives were:

1) a maximum initial armed reconnaissance effort utilizing three carriers at Point Yankee plus all Thai-based aircraft for a total of approximately 450 strike sorties per day, continuing for 72 hours and concentrating on land and water LOCs (outside of the excluded area) in all known areas of transport activity revealed by photo reconnaissance;

2) armed reconnaissance operations against LOCs in southern NVN, resumption of which would be justified by specific enemy action and which would be increased progressively to the tempo and level of intensity recommended by the JCS on 18 January;

3) armed reconnaissance operations against the LOCs and simultaneous strikes against "the infiltration associated DRV POL system, "requiring a third carrier at Point Yankee and Thai-based aircraft.

The JCS also recommended that air operations be initiated in NVN "without prior announcement so as to achieve maximum surprise and effectiveness," in accordance with the program set forth in alternative three, above, and that follow-on actions be as set forth in their recommendations of 18 January 1966.

Remarks. On 15 Feb 66, the SecDef acknowledged receipt of both this JCSM and the related 18 January 66 memorandum above. He stated that "the JCS views will continue to receive full consideration in further development of the ROLLING THUNDER program."

Air operations against NVN recommenced on 31 Jan 66 with a limited sortie rate.

~~SECRET~~

C-42

Appendix C

~~SECRET~~

19 Feb 66 JCSM-113-66: "Air Operations Against North Vietnam (U)"

Summary of Concept. The JCS recommended to SecDef that the air strike program contained in JCSM-41-66 of 18 Jan 66 be approved for immediate implementation. They suggested that "other than military considerations" dictated the exclusion of the northeast area of NVN from attack by US forces, the excluded area be redefined as the area north and east of a line extending from the coast, passing four miles south of Haiphong, ten miles south and west of Hanoi/Phuc Yen Airfield, and north to a twenty NM buffer zone along the northwest Chinese border. In this case, CINCPAC should be authorized 7,400 combat sorties monthly in NVN and 3,000 in Laos, with flexibility for employing his resources as weather and operational factors dictate in order to increase over-all effectiveness. If the excluded area could not be redefined as indicated above, the JCS recommended that the present area of operations be expanded to that existing on 24 December 1965. In this case, CINCPAC should be granted the flexibility to employ resources allocated to Laos and NVN as weather and operational factors dictated.

Remarks. The DEPSECDEF (3 Mar 66 memo) stated that the JCSM was carefully reviewed and certain recommendations incorporated in the decisions reached during the week 20-26 Feb 66.

~~SECRET~~

C-43

Appendix C

~~SECRET~~

Mar 66 JCSM-189-66: "Air Operations Against North Vietnam (U)"

Summary of Concept. On 21 March 1966, SecDef had discussed air operations against NVN with the CJCS and requested "that a controlled armed reconnaissance program be developed against selected LOCs in the northeast quadrant." In a subsequent conversation with CJCS on 23 March 1966, he requested "additional information regarding attacks on the NVN POL system." On 26 March 1966, the JCS provided SecDef with their recommendation that, as a "next step," RT 50 be initiated on 1 April 1966 in accordance with the following:

"a. Controlled armed reconnaissance be conducted at a monthly level of 900 attack sorties over the routes designated in the Appendix.

"b. Attacks be conducted against the nine POL storage areas, six bridges (three restrikes), one cement plant, one iron and steel combine, one thermal power plant, and one EW/GCI radar site as shown in the Appendix.

"c. CINCPAC conduct these operations within the over-all sortie allocation of 8,100 attack sorties for Laos and NVN as the operational situation dictates.

"d. No tactical restrictions or limitations be placed upon the execution of the specific air strikes."

Remarks. The SecDef acknowledged receipt (memo 13 Apr 66) of the JCSM and its use in connection with the decision on ROLLING THUNDER 50, which authorized four bridges and controlled armed reconnaissance along major LOCs in the NE quadrant. In addition, forces were authorized to attack: four dispersed POL sites, a POL tank plant, a truck park and a motor repair facility on 31 May 66; the Viet Tri railroad/highway bridge on 25 Jun 66; and the seven major POL targets and the key GCI site on 29 Jun 66. The level of attack sorties for Laos and NVN was increased from 8,100 to 10,100.

~~SECRET~~

C-44

Appendix C

~~SECRET~~

14 Apr 66 JCSM-238-66: "ROLLING THUNDER Study Group Report
'Air Operation Against North Vietnam' (U)"

Summary of Concept. The Chairman, Joint Chiefs of Staff, on 1 Feb 66, directed that detailed study of ROLLING THUNDER and related programs be conducted, and a comprehensive concept and outline plan be developed for an air effort redirected for optimum military effort. The concept developed by the study group required an "initial application of air attacks over a widespread area against the NVN military base structure and war-supporting resources."

The three-phased plan (with three supporting special attack options) required a "modest adjustment in size of the sanctuaries by reducing the area around Hanoi and the Phuc Yen Airfield to a 10 NM radius, to a 4 NM radius around Haiphong, and to 20 NM from the Chinese border"

"Phase I starts with an expansion of the armed recce area to the northeast and progresses into attacks against a wide selection of targets outside the reduced sanctuaries. These targets should be neutralized over a period of 4 to 6 weeks"

"Phase II intensifies the pressure on NVN by attacks on military and war supporting installations within the reduced Hanoi-Haiphong sanctuary"

"Phase III provides for further intensification through attacks on selected targets from the JCS list that have not been attacked in previous phases"

"Special Attack Option A. Air attacks on the POL entry at Haiphong."

"Special Attack Option B. Aerial mining of the channel approaches to the ports of Haiphong, Hou Gai, and Cam Pha."

"Special Attack Option C. Strikes against the major airfields at Hanoi, Haiphong, and Phuc Yen."

~~SECRET~~

C-45

Appendix C

In addition, "concurrent with this phased target plan is a continuing program of day-and night armed recce."

Remarks. The report was noted by the JCS and forwarded for information to the SecDef. The memorandum stated: "The Joint Chiefs of Staff will consider this study in making recommendations to you on future ROLLING THUNDER programs." No immediate military action developed.

~~SECRET~~

9 May 66 JCSM-295-66: "Rules of Engagement-Southeast Asia (U)"

Summary of Concept. The JCS requested SecDef as a matter of urgency to approve their proposed revised rules of engagement of 1 January 1966 because:

"Enemy aircraft in Southeast Asia have attacked US aircraft over North Vietnam recently with increasing frequency. US aircraft, however, currently are prohibited from immediate pursuit of hostile aircraft into CHICOM air space although recent reaffirmation of earlier public declarations by the Secretary of State indicate that no such enemy sanctuary exists. This anomaly serves both to compromise US forces by unduly hampering their response to attacks by hostile forces and to invite attacks by enemy forces operating from or retiring to CHICOM bases. It is imperative that guidance to US forces be clarified and that they also be provided with clear operational authority and guidance consistent with their legitimate right of self-defense."

Remarks. SecDef provided the JCS (memo for CJCS dated 16 May 66) with an interim response to the proposed revised rules of engagement recommended in JCSM-8-66 of 1 Jan 66 above and this JCSM. Commenting on pursuit into Communist China in response to attack against US forces, he said:

"The current rules of engagement . . . are clear and unequivocal (sic) regarding incursions into Communist China and reflect current US Government policy: 'No pursuit is authorized into territorial seas or air space of Communist China.' In the event that Communist Chinese forces become directly involved in hostilities in Southeast Asia, this rule would obviously require reconsideration; and under such circumstances, I am confident that Chinese territory would not be accorded the status of a 'sanctuary'."

SecDef believed the rules contained a statement which met emergency situations "wherever and whenever they develop":

~~SECRET~~

C-47

Appendix C

"Nothing in these rules modifies in any manner the requirement of a military commander to defend his unit against armed attack with all the means at his disposal. In the event of such an attack, the commander concerned will take immediate aggressive action against the attacking force."

(On 31 May 1966, the JCS provided CINCPAC with these comments, and instructed him that the 17 April 1965 rules of engagement, as modified on 26 May 1965, would remain in effect until he was notified otherwise.)

~~SECRET~~

Appendix C

~~SECRET~~

22 Nov 66 JCSM-727-66: "Suspension of Military Operations (U)"

Summary of Concept. The JCS stated to SecDef that:
"Pressures for a stand-down of military operations during the Christmas and Tet holidays are already beginning. The Joint Chiefs of Staff are strongly opposed to any stand-down in military operations during these holiday seasons; however, if some type of cease-fire is directed, they recommend it be limited in order to minimize the significant military advantages this offers the Viet Cong/North Vietnamese Army. Moreover, if a stand-down is directed, an early decision should be made as to the timing and scope of cessation of bombing in North Vietnam and/or reduction of ground operations in South Vietnam during the holiday period in order to permit sound military planning for such actions."

"A cessation of military activities must be accomplished with minimum over-all degradation of military operations."

The JCS pointed out that during the 1965-66 Christmas-Tet stand-down the enemy had been provided military advantages while "our forces suffered distinct military disadvantages." They emphasized that NVN had been given time to recover from previous bombings and to make significant preparations to defend against renewed air strikes. The JCS favored limited stand-downs at Christmas and Tet to "a maximum of 48 hours in each instance" with all air operations in Laos and air recce over NVN and RVN continuing during the stand-down. Specific authority should be given to CINCPAC to strike any "unusually lucrative or threatening military targets in North Vietnam" that might develop as a result of the stand-down. The JCS stated that US military action preceding the cease fire should be intensified so that:

"there is a large element of doubt in the enemy's mind as to the level of effort at which we will reinstitute our operations. In this respect the Joint Chiefs of Staff recommend a sharp increase in the intensity and, if possible, the scope of air operations in North Vietnam both prior to and immediately after any stand-down."

~~SECRET~~

C-49

Appendix C

~~SECRET~~

27 Dec 66 JCSM-792-66: "Proposed National Security Action Memorandum (NSAM), 'Strategic Guidelines for 1967 in Vietnam' (U)"

Summary of Concept. The draft NSAM was reviewed by the JCS at the request of the acting Assistant Secretary of Defense (ISA) dated 14 December 1966. This paper submits a revised draft with specific objectives for the air campaigns in NVN as follows:

Intensify operations to make it as difficult and costly as possible for NVN to support aggression and to reduce substantially infiltration into SVN.

(1) Adjust the air and naval offensive with respect to the extent and quality of targets.

(2) Increase the anti-infiltration capability, thereby further reducing, impeding and obstructing the flow of men and material into SVN.

(3) Without prejudicing other aspects of the overall military effort, consider proceeding with such increments of a barrier system as are determined to be militarily useful and feasible.

(4) Seek and apply additional economic, political, psychological and military pressure on the North.

Remarks. The Department of Defense comments (DEPSECDEF memo to Special Assistant to the President dated 28 Jan 64) on the draft NSAM fall short of the intent on item (1) in refinement of air and naval operations vice broadening of the target base.

~~SECRET~~

~~TOP SECRET~~

18 Jan 67 JCSM-25-67: "US Policy for TET 1967 (U)"

Summary of Concept. The JCS expressed their opposition to the "Tet Stand-down or any extension thereof because of the high military cost to US, Republic of Vietnam (RVN), and allied forces incurred by the numerous, repeated, and deliberate infractions of past stand-downs announcements by the enemy." They stated opposition "to a policy which allows the enemy to strengthen his tactical posture without permitting adequate counteractions." They recommended selected military measures, nevertheless, to reduce the enemies ability to enhance his posture during the stand-down by a continuation of SEA Dragon operations against military and logistic watercraft and attacks on major resupply activity on LOCs south of 19° N.

Remarks. No favorable action was developed and the TET (8-14 Feb) was instituted without implementation of the recommendations.

~~TOP SECRET~~

C-52

Appendix C

~~SECRET~~

APPENDIX D

NORTH VIETNAM AIR DEFENSE SYSTEM

1. (S) The North Vietnam Air Defense System has developed from a rudimentary system in 1964 to a formidable, relatively complex and modern system in 1967. The system is expected to continue its development as long as requirements to counter actual or potential US military actions exist.

2. (S) The NVN radar system has developed in two years to provide total EW coverage and near total GCI capability for the entire country. As of 20 February 1967, 440 radar sets have been identified, of which 165 are in the EW/GCI system. AAA fire control and SAM missile control radars provide protection of all vital areas often with significant duplication. Due to this overlapping of radar coverage and significant duplication of equipment in most areas the quantity of radar imported in the future will be less than that imported in the past and the build-up rate will slacken. Qualitative changes can be expected with more modern radars, particularly in the EW and GCI categories, replacing older types. The fire control radars for AAA will probably continue to show a quantity increase and the SA-2 FANSONG radar will build with any increases in SAM battalions.

3. (S) The present AAA order-of-battle in North Vietnam reflects a density affording multiple caliber protection to vital targets and lines of communication. The growth in AAA has been rapid, some 15 fold since 1964. This growth is expected to continue at a less rapid pace to provide for more heavy caliber guns and increased gun count in the southern regions. If a proximity fuze were introduced along with more fire control radar the near miss occasions would decline and kill probabilities increase. The Soviet development of a 57mm AAA proximity fuze is relatively new and subject to compromise if the fuze were used in NVN. The initial detection of proximity fuzing in AAA is more likely to occur in the 85 and 100mm weapons.

~~SECRET~~

~~SECRET~~

4. (3) The present SAM system (the SA-2, S-band) has accounted for nearly 50 shootdowns, including possibilities, with over 1,700 missiles fired. The system has degraded the accuracy of US ordnance delivery and seriously impaired the ability of the United States to acquire aerial photography. The Red River delta area is protected in depth by missiles, and frequent photographic coverage of the essential military and logistics complexes located there is needed. High flying U-2 aircraft and photographic drones are particularly vulnerable to the SA-2 missile. At the present time 161 fixed SAM sites are capable of accepting SA-2 firing units. These sites are located primarily in the Hanoi, Haiphong, Nam Dinh delta area and along coastal LOCs to the north and south. Maximum attention is now devoted to the detection of SAM facilities in the DMZ region in order to control the threat to B-52 operations. In addition to fixed sites the SA-2 system can be operated from hastily prepared field sites which are difficult to detect. From selecting of a field site to launch capability is a period of four to six hours. Based on a review of SAM activity, operating characteristics and growth rate since July 1965 and an estimate of projected NVN requirements and capabilities, it is estimated that NVN SAM system will expand from the present 25-30 battalions to at least 40-45 within the next two years. In doing so the inventory of FANSONG radars, launchers, control vans, and crews would have to be proportionally increased and the requirement for support areas would increase considerably. This would be a significant undertaking for North Vietnam. Thus far, they have indicated their insistence to control and operate the SAM system and would probably attempt the expansion with minimal Soviet operational assistance. An expansion much greater than 40-45 battalions would probably cause a departure from this basic policy. In addition, the importation of missiles would be doubled or more since missile expenditure would probably increase, adding additional loads to the logistics and support systems. Following present observed operational practice this 40-45 battalion strength would provide air defense in all major military and LOC areas and allow four to five prepared sites per battalion for mobility for protection from air attack. The relative merits to be achieved through the introduction of a C-band SA-2 system or a SA-3 are believed small. A C-band system provides some frequency diversity for ECCM, possibly increased missile maneuverability and an increased ability

~~SECRET~~

~~SECRET~~

to intercept lower altitude targets. The present kills being achieved by AAA or low altitude targets offset to some extent the need for a low altitude missile system. This is essentially the same envelope for which the SA-3 is designed. In addition, the SA-3 appears to have suffered development problems. The probability that the C-band and SA-3 systems will be introduced is therefore small. There is no evidence at present that North Vietnam or the Soviet Union has an operational infrared SAM. While there is evidence that the Soviet Union recognizes the need for a missile like the US REDEYE or CHAPPARAL, no indications of its development have been noted.

5. (S) Although it is not currently inflicting significant losses on US aircraft, the NVN Air Force does pose a threat. A number of strike aircraft have failed to complete their assigned missions when MIG encounters or indications of hostile intent have caused them to jettison their ordnance. Fighter bases are expanding, both in airfield improvements and new construction. Hoa Lac Airfield near Son Tay was photographed in March with five MIG-17s present, thus the field is ready for at least limited fighter operations. Kep shows signs of becoming a primary tactical base, and Bai Thuong, near Thanh Hoa, could soon be completed. The use of Bai Thuong would extend fighter interceptor capability over the southern regions of NVN land and off-shore areas and provide coverage for Laos and the northern regions of South Vietnam. The NVN inventory of 114 jet fighters could increase. At least 32 MIG 15/17 replacements are now ready at Peitun/Yunnani, China. MIG-21 FISHBED and all weather interceptors, both FISHBED and FRESCO, using cannon, rockets, and air-to-air missiles, could increase the night and adverse weather intercept capability. Aircraft of greater capability than the MIG-21 do not seem to be required for the defensive role now assigned to the NVN Air Force. The poor showing in combat, thus far, is probably more a factor of pilot technique than aircraft capability. The speed and maneuverability of the MIG-21 above 15,000 feet is comparable to the US F4. The ATOLL AAM is a copy of the US SIDEWINDER and with proper technique should perform comparably. The LAKALI beam rider AAM is inferior to the US SPARROW. These Soviet missiles would not necessarily perform better on most newer Soviet jets as the basic

~~SECRET~~

~~SECRET~~

aircraft weapons control systems are the same. The SU-FITTER would provide more speed and endurance, however, this alone would not give North Vietnam the edge. Logistic and technical problems would increase with the introduction of a newer generation fighter, and pilot training would have to be considered. There has been a standardization pattern developed in other forms of armament as well as airfield in North Vietnam and other SOVIET supported areas. It would be a departure from this pattern to add another basic aircraft type requiring separate support within the supply system. The MIG-21 has shown a highly satisfactory in-commission rate presumably due to the reliability and relative lack of complexity of its components.

6. (S) The command and control of the air defense system appears to be achieving a reasonable degree of sophistication. US aircraft are faced with AAA and SAM defenses as soon as they penetrate the coast line from the east or enter the Red River and delta areas from the west. This indicates a sufficient degree of coordination between radar surveillance and weapons systems selection and command. MIG interceptors contact US aircraft during cloudy as well as clear weather and approach in a manner indicative of radar vectored intercept. Although there have been occasions of MIGs, SAMs, and AAA being used simultaneously, this is not the usual case. There does seem to be an element of control exercised whereby NVN defensive systems are coordinated in their application to defend against US air attacks. Presumably a central Air Defense Headquarters is monitoring the air picture and directing the use of the various air defense weapons systems.

7. (S) The North Vietnamese suffer from a lack of sufficient talent in technical areas. If North Vietnam chose to or were forced to maintain their air defense system without external material and technical support the system effectiveness would soon be degraded. On the other hand, North Vietnam is the only country in the world gaining daily experience in air defense. Early warning capabilities are probably becoming highly effective in detecting and defining hostile targets and providing a reasonable projection of flight paths. Multiple radar sets at radar sites provide for survivability in attacks and frequency diversification in a jamming environment.

~~SECRET~~

~~SECRET~~

The density in AAA weapons reduces the vulnerability to attack and provides multi-caliber protection of military targets and lines of communication. Command and control of weapons and other components within the air defense system are believed to be exercised through a radio system probably capable of variable frequency for a measure of protection against jamming. The relatively small geographic area involved does not demand radio equipment of large size requiring major power equipment. Such a radio system is extremely difficult to destroy or render ineffective. The mobility of the SA-2 system within the large number of prepared sites provides North Vietnam with a significant ability to avoid or recover from attacks on SA-2 firing units. Airfields and jet aircraft are vulnerable to attack, however, a well protected system of revettments affords much protection for aircraft and an abundance of labor can probably achieve rapid repairs to the airfield proper, should it be damaged. Damaged aircraft, however, would cause a significant burden to be imposed on in-country capabilities for major repair and a course of cannibalization would probably follow.

3. (C) The weather in North Vietnam has a bearing on both US air and NVN ground operations. During the NE monsoon, November through February, ground operations are not seriously effected north of Vinh while to the South heavy rainfall has an adverse effect. In this same period air operations are hampered generally throughout North Vietnam. Beginning in March, the inland and mountain areas of North Vietnam are subject to adverse weather which affects US air operations more than ground movement. Moving to the period May through September, air operations are unhampered generally from the coast inland to Hanoi and to the southern mountain chain. At this time ground movement capabilities are good near the coast and in the southern mountains, however, movement in Laos is restricted due to heavy rainfall. In October, the southern mountains open up to air operations but southern coastal areas receive heavy rainfall and cloudiness prevails in the Laotian panhandle.

9. (S) The entire air defense system depends on foreign support. The Soviet Union and Communist China play vital roles not only in hardware and technical assistance, but also in providing the means and routes

~~SECRET~~

~~SECRET~~

of import. Without this support North Vietnam would be unable to maintain or operate the present air defense system adequately for a prolonged period. The capability of North Vietnam to expand and develop its air defense system, therefore, is basically that of the Soviet intentions tempered by North Vietnam desires to control the system.

10. (S) The capability of the Soviet Union to supply hardware and support material via overland routes to North Vietnam is, to an extent, affected by Sino-Soviet relations and the ability and desire of North Vietnam to "straddle the fence." China could refuse the Soviets the use of the overland rail route through China or put obstacles on the path. If this event occurred, the Soviets might run the risk of a US confrontation on the high seas by shipping all military material by sea. While the problems of Sino-Soviet relations have been reflected in public quarrels over rail shipments, there is no evidence that they have affected the actual passage of aid to North Vietnam. Under conditions wherein the northeast rail lines, sea lanes, and port facilities are relatively immune from attack, external support to North Vietnam will probably continue to be sufficient to counter increased levels of US activity and continue to support the general development of the NVN air defense system.

~~SECRET~~

~~SECRET~~

ANNEX A TO APPENDIX D-

RADAR

1. (S) The NVN radar network is composed of various radar equipments required to support early warning (EW), ground controlled intercept (GCI), antiaircraft artillery (AAA), and the surface-to-air missile (SAM) systems. In the past four years, the radar order of battle has increased from a total of 24 pieces of equipment in 1962 to 440 pieces in February 1967. During this growth period, the number of fire control radars for AAA increased from six to 246 and the EW/GCI associated radars increased from 18 to 165. Also, since July 1965, there have been 23 FAN SONG, SAM fire control radars, identified in North Vietnam.

2. (S) There is a multiplicity of radar equipments that provide an extensive redundance of functional capability. This redundancy is well-illustrated in that there are six BIG BAR B/BAR LOCK, EW/GCI capable radars located within 25nm of each other north of Hanoi. These radars have an EW range of 215/220nm and a GCI range of 110/210nm respectively against a medium reflective target (F-4 and F-105) at 40,000 feet altitude. The redundance of equipment provides the advantage of frequency diversity, system reliability, and increased combat survivability. The increase in numbers of radars has also provided greater operational flexibility since radars can now be redeployed or serviced without loss of aircraft tracking capability. Such a system could sustain considerable heavy equipment and personnel losses and still function as a viable system making a significant contribution to the air defense effort.

3. (S) The physical size of North Vietnam does not warrant the deployment of such large numbers of radars. However, this extensive deployment is not unusual since it generally follows patterns observed in other Soviet-equipped countries.

4. (S) The Aircraft Warning (AW) network consists of an integrated chain of field radar sets, radar reporting stations, filter centers and headquarters facilities. It is estimated that an average system time of three to

~~SECRET~~

DA-1

Annex A to
Appendix D

~~SECRET~~

five minutes is required to pass aircraft tracking data from initial detection by the field radar, through the reporting station and filter center, to the Hanoi Air Defense District headquarters. From the headquarters, the data is probably disseminated to an indeterminate number of consumers, among whom are, at least, the various defensive weapons controllers.

5. (S) In addition to the NVN internal AW network, Hanoi probably has access to aircraft tracking data gleaned from Chinese communist air surveillance facilities located along the joint Sino/NVN border.

6. (S) Along with the increase in numbers of radar equipments, North Vietnam has realized significant improvement in the quality and sophistication of equipment. In 1964, NVN early warning (EW) radars were primarily the MOON FACE, RUS-2, KNIFE REST, and CROSS SLOT with a single FLAT FACE radar at Phuc Yen airfield. This equipment provided reasonably good medium to high altitude EW coverage over the entire country as well as portions of Laos, South Vietnam, and the Gulf of Tonkin.

7. (S) By February 1967, the radar inventory included 11 BAR LOCK/BIG BAR B/TOKEN heavy type EW/GCI radars. The FLAT FACE and SPOON REST EW/target acquisition radar inventories have grown to 30 and 46 respectively, with 16 ROCK/STONE CAKE/SIDE NET height finders now probably providing the essential altitude information on hostile air tracks. This newer, improved equipment increased the medium to high altitude area coverage to a moderate degree and significantly increased the average detection range against lower flying targets - 3000 feet and below. The present detection perimeter around North Vietnam has excellent continuity; possible penetration corridors caused by previous coverage gaps have now been filled.

8. (S) Since the Chinese communists and the Soviets construct and use many identical types of radar equipment, it is difficult in some cases to determine North Vietnam's actual source of supply. The KNIFE REST A/B, ROCK CAKE/STONE CAKE, RUS-2, MOON FACE (SCR 270), SCR 584, FIRECAN, WHIFF, and TOKEN are common to both countries and have been provided North Vietnam. The CHICOM early warning and coastal surveillance radar, CROSS SLOT, has

~~SECRET~~

DA-2

Annex A to
Appendix D

~~SECRET~~

been supplied by the Chinese communists. It is believed that most of the more modern radars are provided by the Soviet Union and Warsaw Pact countries, since very few, if any, of these equipments have been noted in the Chinese communist inventory. The BAR LOCK, BIG BAR, SPOON REST, FAN SONG, FLAT FACE, ROCK/STONE CAKE, and SIDE NET are now probably exclusively furnished by the Union of Soviet Socialist Republics and Warsaw Pact countries.

9. (S) The following radar equipments by name and function are currently identified in the DIA North Vietnam Electronic Order of Battle (EOB), dated 20 January 1967:

<u>Equipment Name</u>	<u>Function</u>	<u>Number of Sets Identified</u>	
		<u>Active</u>	<u>Suspense</u>
BAR LOCK	EW	5	
BIG BAR B	EW/GCI	3	
CROSS SLOT	EW	17	
FLAT FACE	EW/SAM ACQ	30	
KNIFE REST A/B	EW	22	2
MOON FACE (SCR-270)	EW	13	2
RUS-2	EW	6	
SPOON REST A	EW/SAM ACQ	46	3
TOKEN	EW/GCI	<u>3</u>	<u>-</u>
	SUB TOTALS	145	7
FAN SONG A/B	Missile Control	23	6
FIRECAN	Fire Control	125	9
SCR-584	Fire Control	1	
WHIFF	Fire Control	9	1
UNIDENTIFIED	Fire Control	<u>111</u>	<u>7</u>
	SUB TOTALS	269	23
ROCK/STONE CAKE	Height Finder	11	2
SIDE NET	Height Finder	<u>5</u>	<u>-</u>
	SUB TOTALS	16	2

~~SECRET~~

DA-3

Annex A to
Appendix D

~~SECRET~~

<u>Equipment Name</u>	<u>Function</u>	<u>Active</u>	<u>Suspense</u>
FISH NET	IFF Interrogator	0	1
SCORE BOARD	IFF Interrogator	<u>4</u>	<u> </u>
	SUB TOTALS	4	1
HOME TALK	CGA/Precision Approach	1	
ONE EYE	GCS Air Surveillance	2	
BEAM TRACK	Search Light Control	2	
SHEET BEND	Coastal Surveillance	0	1
	Target Acquisition		
DRY RACK	Communications	<u>1</u>	<u> </u>
	SUB TOTALS	6	1
	GRAND TOTALS	440	34

10. (S) For individual equipment location and degree of site accuracy, reference DIA Secret publication "North Vietnam Electronic Order of Battle" published monthly. Following is a summary of active radar equipments and their associated radii of positional accuracy expressed in nautical miles circular error probable (CEP):

EW/GCI ASSOCIATED EQUIPMENT

<u>Equipment Name</u>	<u>Function</u>	<u>Radius of Accuracy (NM)</u>							<u>TOTAL</u>
		<u>00</u>	<u>01</u>	<u>02</u>	<u>03</u>	<u>05</u>	<u>10</u>	<u>15</u>	
BIG BAR B	EW/GCI	1		1		1			3
TOKEN	EW/GCI	1	1			1			3
BAR LOCK	EW/GCI*	2				2			5
CROSS SLOT	EW	4	1			1	6	4	17
FLAT FACE	EW	5	2	4	11	4	3	1	30
KNIFE REST	EW	8	7	2		1	4		22
A/B									
MOON FACE	EW	6	2	1		3		1	13
RUS-2	EW	2	1			1	2		6
SPOON REST A	EW/SA-2	12	7	1	17	7	2		46
	ACQ								

* When used with a height finder radar.

~~SECRET~~

DA-4

Annex A to
Appendix D

~~SECRET~~

<u>Equipment Name</u>	<u>Function</u>	<u>00</u>	<u>01</u>	<u>02</u>	<u>03</u>	<u>05</u>	<u>10</u>	<u>15</u>	<u>TOTAL</u>
ROCK/STONE CAKE	H/F	3	4		1	1	2		11
SIDE NET	H/F	3			1			1	5
SCORE BOARD	IFF			1	3				4
	<u>TOTALS</u>	47	25	10	37	24	17	5	165
	PERCENTAGE*	28.5	15	6	22.5	14.5	10.5	3	100

SAM CONTROL RADARS

<u>Equipment Name</u>	<u>Function</u>	<u>Radius of Accuracy</u>						
		<u>00</u>	<u>01</u>	<u>02</u>	<u>03</u>	<u>05</u>	<u>10</u>	<u>TOTAL</u>
FAN SONG A/B	SA-2 Con- trol	15	1			6	1	21
	Percentage	65	4.5			26	4.5	100

AAA FIRE CONTROL RADARS

FIRECAN	Fire Con- trol	97	27			1		125
WHIFF	Fire Con- trol	7	1			1		9
UNIDENTIFIED (FC)	Fire Con- trol	105	6					111
SCR 584	Fire Con- trol		1					1
	<u>TOTALS</u>	209	35			2		246
	PERCENTAGE	85	14			1		100

*Percentage figures show percentage of total radars for each radius of accuracy.

~~SECRET~~

DA-5

Annex A to
Appendix D

SECRET

11.(S) The majority of radar systems employed by North Vietnam are highly mobile, requiring from only a few minutes (10 minutes for FLAT FACE) to a few hours (8 hours for the BIG BAR) to set up. Normally, the "break down" of equipment for movement requires even less time. This mobile capability has been used consistently by the North Vietnamese to prevent our pinpointing radars for preplanned attack. If the North Vietnamese believe a radar has been located and is vulnerable to attack, they quickly redeploy the equipment.

12.(S) Further, North Vietnamese attempts to decrease the vulnerability of radar equipments to air attack have resulted in the locating of radars in or adjacent to natural foliage or populated areas. The foliage provides natural concealment making identification and location of equipment especially difficult, while the collocation of radars in populated areas not only helps avoid detection, but also takes full advantage of our policy of not endangering the NVN civilian populace.

13.(S) The radar equipments themselves can be damaged or neutralized. In the case of van/truck mounted systems which comprise the vast majority of radars, the van can be overturned or its walls breached by blast; fragments and projectiles can penetrate the van and damage internal equipment; or electrical power can be denied the system. Although the exact internal arrangement of equipment is not known, it can be assumed that maximum advantage is taken of all available space. Therefore, penetration of the van walls should damage electronic circuitry and cut cables that control the radar. The antenna system, using either yagi array or parabolic reflectors, cannot be considered highly vulnerable because of the size and nature of the components.

14.(S) For the time period mid-1968 through mid-1970, the spectrum of radar equipment in North Vietnam should not change drastically from that currently in use. Some refinements may be expected in equipment utilized and in system operation to counteract US electronic warfare activities.

15.(S) While the numbers and types of EW/GCI related radar are expected to remain relatively stable as stated,

SECRET

DA-6

Annex A to
Appendix D

~~SECRET~~

a continued expansion of fire control radar equipment may be anticipated to accommodate the 57/85mm AAA and the growth of the SA-2 systems.

16.(S) Practically all of the EW/GCI radars including height finders utilized in the NVN air defense system are mobile as previously stated. The mobility of the radar equipment requires a mobile power source which generally consists of two electrical power (diesel) generators for each type radar (prime and back-up sources). Although some of the equipment data indicates that commercial power (200V50CPs) may be used if available, it is not believed to be the case in North Vietnam where commercial power sources in Route Packages I through IV have been made inoperative as a result of air attacks. In addition, some TPP plants in Route Package 6A/B have also been destroyed. The generally remote siting of radar equipment for EW/GCI coverage, indicates a substantial if not total requirement for a self-sufficient electrical power source with a back-up capability.

17.(S) Power Outputs by Radar Type

BIG BAR	1mw per beam
TOKEN	750 kw
BAR LOCK	2 mw per beam
CROSS SLOT	.5 - 1.0 mw
FLAT FACE	500 kw
KNIFE REST	70 - 100 kw
SPOON REST	350 kw
ROCK CAKE	3 mw
STONE CAKE	3 mw
SIDE NET	3 mw
SHEET BEND	250 kw
ONE EYE	500 kw
HOME TALK	15 - 20 kw
SCORE BOARD	2 kw
FISH NET	500 watts
FAN SONG	600 kw
FIRE CAN	250 kw
WHIFF	250 kw

18.(S) A correlation has been made of the Fire Control (FC) radars reflected in the DIA EOB, 20 January 1967, with the antiaircraft sites shown in the PACAF Antiaircraft

~~SECRET~~

DA-7

Annex A to
Appendix D

SECRET

Order of Battle (AOB) 21 December 1966. This correlation shows that 196 of 227 active and 13 of 16 suspense fire control radars in the EOB match up with known antiaircraft positions:

<u>EOB FC Radars</u>	<u>Match</u>	<u>Do Not Match</u>
227 Active	196	31
<u>16 Suspense</u>	<u>13</u>	<u>3</u>
243	209	34

84% Match
14% Do Not Match

SECRET

DA-8

Annex A to
Appendix D

~~SECRET~~

NUMBERS OF RADARS IN SANCTUARY

By Function and CEP[±]

<u>EW/GCI</u>	<u>00</u>	<u>01</u>	<u>02</u>	<u>03</u>	<u>5</u>	<u>10</u>	<u>15</u>	<u>Totals</u>
0-10nm (HP) *	4	1	2	3	2	0	0	12
0-10nm (HN) **	5	6	0	2	2	0	0	15
10-30nm	<u>10</u>	<u>2</u>	<u>0</u>	<u>14</u>	<u>1</u>	<u>1</u>	<u>1</u>	<u>29</u>
Total	19	9	2	19	5	1	1	56

FIRE CONTROL

0-10nm (HP)	10	1	0	0	0	0	0	11
0-10nm (HN)	55	7	0	0	0	0	0	62
10-30nm	<u>37</u>	<u>6</u>	<u>0</u>	<u>0</u>	<u>0</u>	<u>0</u>	<u>0</u>	<u>43</u>
Total	102	14	0	0	0	0	0	116

FAN SONG

0-10nm (HP)	1	0	0	0	0	0	0	1
0-10nm (HN)	4	0	0	0	0	0	0	4
10-30nm	<u>6</u>	<u>1</u>	<u>0</u>	<u>0</u>	<u>2</u>	<u>0</u>	<u>0</u>	<u>9</u>
Total	11	1	0	0	2	0	0	14

GRAND TOTAL 186

* (HP) = Haiphong

** (HN) = Hanoi

~~SECRET~~

DA-9

Annex A to
Appendix D

SECRET

19. (S) Data on Various Radar Bands

<u>Band</u>	<u>Frequency (megacycles)</u>
P	225-390
L	390-1550
S	1550-5200
C	3900-6200
X	5200-10900 (overlaps C Band)
K	10900-36300

20. (S) Some Radars Common to Southeast Asia with Given Frequency (Excludes Friendly Radars)

<u>Frequency</u>	<u>Type Radar</u>
70-270	KNIFE REST (EW) SPOON REST (EW and Acquisition for SA-2) MOON CONE (EW) MOON FACE (EW) FISH NET (IFF - both airborne and shipborne)
655-914	SCOREBOARD (IFF- landbases) Guidance band (L-Band) of FAN SONG SA-2 associated radar CROSS UP (Airborne IFF) FLAT FACE (EW/Acquisition)
2578-3140	FIRE CAN (AAA fire control) WHIFF (FC) FAN SONG S-Band (tracking) CROSS SLOT (EW) TOKEN (EW) BIG BAR (EW) BAR LOCK (EW) SKIN HEAD (Shipborne-warning of surface and low-flying targets) Many other EW/GCI radars SIDE NET (HF) ROCK CAKE (HF)
8960-9775	SPIN SCAN (Airborne radar aid to interception) SCAN ODD (Airborne radar aid to interception) HIGH FIX (Airborne radar) SHEET BEND (Coastal warning radar) Possibly LOW BLOW (SA-3 associated)
DA-10	Annex A to Appendix D

SECRET

~~SECRET~~

ANNEX B TO APPENDIX D
ANTI-AIRCRAFT ARTILLERY (AAA)

1. (S) The NVN AAA and AW system consists essentially of six weapons:

			<u>Theoretical</u>		
			<u>Max Effect Range</u>	<u>Practical Rate of Fire</u>	
12.7mm	DSHK 38/46	HMG	3,300 ft.	80 Rounds per Min	
14.5mm	ZPU		4,600	150	"
37mm	M1939	AAA	5,600	80	"
57mm	S-60	AAA	13,100	70	"
85mm	KS-12	AAA	27,500	15-20	"
100mm	KS-19	AAA	39,000	15	"

2. (S) The 14.5mm ZPU is built in three versions, of one, two and four barrels. The two-barrel ZPU-2 and four-barrel ZPU-4 have been identified in North Vietnam. The 37mm AA weapon is the smallest size AA gun identified in country, and is strictly a manually-directed weapon - it has no capability for radar fire control. Both the 85mm and 100mm weapons can effectively be used only with radar fire control, whereas the 57mm S-60 can be used in either mode normally depending upon availability of the radar. Using fire control radar, the maximum effective range of the S-60 is increased nominally from 13,100 feet to 19,700 feet.

3. (S) A self-propelled version of the 57mm gun is known to be in country, but only eight have been identified and always in the general vicinity of Phuc Yen. This weapon, the ZSU-57-2, is essentially two 57mm guns, without radar control, on a tank chassis. The use of motorized ZPU-s's has also been noted periodically in photography. This consists of mounting the single-axle ZPU-2 onto the bed of a BTR-40 carrier. While all AAA

~~SECRET~~

DB-1

Annex B to
Appendix D

~~SECRET~~

in North Vietnam is "mobile" in the sense of being readily transportable to new locations, the ZSU-57-2 and the ZPU-2/BTR-40 combination are the only weapons that can be fired almost instantaneously from a traveling position.

4. (S) Three other AA weapons are available from Soviet bloc countries, but have not been identified to date in North Vietnam. The weapons and basic characteristics are listed below:

	<u>Theoretical Max Effective Range</u>	<u>Practical Rate of Fire</u>
ZU-23-2 23mm	6,600 ft	200 Rounds per Minute
30mm AA M-53	5,600 ft	100 "
130mm KS-30 AAA	45,000 ft	10-12 "

5. (S) While the 23mm and 30mm weapons are relatively new, and may well be deployed to Vietnam in the future, the 130mm is an obsolete weapon in Soviet arsenals, and could add little to the over-all system. The Soviets consider the 130mm weapon as having been replaced by the SA-2.

6. (S) The current (2 February 1967) AAAOB for North Vietnam is 4549 Light (35/57mm) and 1799 Medium Weapons (85/100mm), plus a number of Automatic Weapons. This is an increase of 120 percent since January 1966. The overwhelming growth in actual guns has been in the NE quadrant, as is shown in the chart below:

	<u>January 1966</u>	<u>January 1967</u>	<u>Gun Increase</u>	<u>Percent Increase</u>
Light (37/57mm)	1443	4549	3106	215
Medium (85/100mm)	1441	1799	358	25
All AAA Wpns	2884	6348	3464	120
RP #1 Wpns	139	491	352	253
#2 Wpns	97	349	252	260
#3 Wpns	275	487	212	77
#4 Wpns	519	683	164	32
#5 Wpns	382	587	205	54
#6 Wpns	1472	3761	2289	156

~~SECRET~~

DB-2

Annex B to
Appendix D

~~SECRET~~

7. (S) The number of AAA weapons in country equates to approximately 100 regimental-equivalents. Little is known about unit organization and subordination. The 367th AAA Division is assumed to function as the senior AAA authority, but only 8-12 regiments have been identified as directly subordinate to it. Some apparently independent AAA regiments, battalions and companies have been identified, and several regiments or regimental-equivalents can be accounted for as part of regular infantry divisions and brigades. Some of the smaller weapons (primarily 37mm and 14.5mm ZPU) are manned by militia and other local, part-time forces. The huge amount of personnel involved, both full and part-time, in the AAA system is probably partially supplied by the use of completely untrained recruits and laborers in the unskilled positions, and there is no dearth of opportunities for on-the-job training.

8. (S) Some AAA units are located with, and probably under the control of SA-2 battalions. These AAA units provide protection from low altitude attack as well as possibly forcing US aircraft to stay up in SA-2 range.

9. (S) The AAA batteries, like the SAM units, are highly mobile, and the number of useable sites far exceeds the number of weapons to occupy them. The batteries move in response to the US strike pattern as well as to hinder flak suppression.

AA guns, automatic weapons and small arms have accounted for approximately 85 percent of US aircraft losses in North Vietnam. This effectiveness depends in part on the presence of the SA-2 missile system, which has forced aircraft to operate more extensively than usual in the AAA environment.

10. (S) Some CHICOM AAA organizations are in North Vietnam and are estimated to be primarily employed along rail lines leading from Hanoi to the Chinese border. Current estimates place the number of CHICOM AAA units at about four divisions.

~~SECRET~~

DB-3

Annex B to
Appendix D

11.(3) Accuracy of AAOB

a. The AAOB data is clearly not sufficiently accurate for many tactical purposes or detailed analyses. The basic problem appears to be one of the date of the photography upon which the AAOB is based. For example, the 2 February 1967 AAOB carries 73 active AA sites in Route Package II, a much-photographed area of North Vietnam. The dates of the photography are as follows:

<u>Year</u>	<u>Months</u>	<u>Number of Active Sites</u>
1966	Dec	15
	Sep-Nov	13
	Aug	14
	Feb-Jul	11
	Jan	5
1965	ALL	<u>15</u> (no photo ref)
Total 2 Feb 67 AAOB		73

b. It is unlikely that the portion of the AAOB based on photography in mid-1966 provides an adequate basis for targeting. Similarly, the AAOB implies that the buffer zone around the CHICOM border is weakly defended. The 2 February 1967 AAOB for Lang Son, key point on the northeast rail line, has the following basis:

<u>Mission</u>	<u>Date</u>	<u>Sites</u>	
		<u>Occ</u>	<u>Unocc</u>
Unspecified	Aug 65	1	-
Blue Springs 5144	April 24, 1966	7	24
Blue Springs 5144	July 14, 1966	1	5

c. In the time since these observations were made, the AAOB elsewhere in Route Package VI has more than doubled. The data on Lang Song provides no reason to believe that this has not also occurred in the buffer zone.

~~SECRET~~

ANNEX C TO APPENDIX D.

SURFACE-TO-AIR MISSILES

1. (S) The North Vietnamese SAM organization presently comprises 25-30 operating battalions, or firing units. The units are primarily located in the Phuc Yen-Hanoi-Haiphong area, with two to three units in the vicinity of Vinh. Soviet practice calls for a regimental authority for each five to eight battalions which would call for four to six regiments for the 25-30 battalions.

2. (S) The overall SAM authority is undoubtedly in the Hanoi area, probably at Bac Mai near the Air Defense Headquarters.

3. (S) AAA units of various size weapons often operate with, and in support of, the SAM battalions. Their control and logistics are apparently handled in the SAM channels along with the SAM battalion. The AAA provides support for the SA-2 site against low-altitude and close-in aircraft, and at times when the SAM unit is unable to fire.

4. (S) A battalion consists of the FAN SONG radar, three to six missile launchers and support equipment, and an estimated complement of 150 men. The standard Soviet configuration is for six launchers to a battalion, and most of the identified sites in North Vietnam consist of six launch positions. Recently, however, there have been increasing indications that many battalions are only employing three launchers, as a number of field sites deployed have only three or four positions.

5. (C) This could possibly indicate an equipment shortage; however, a more logical reason is probably a result of the singularly North Vietnamese employment of the SA-2 system. In a fixed site concept, the standard six launchers allow for back-up launchers in case of damage or required maintenance. Additionally, while the computer can only handle three missiles in flight at a given time, the extra launchers can provide immediate replacements without the delay of

~~SECRET~~

DC-1

Annex C to
Appendix D

~~SECRET~~

launcher reloading. In the Vietnamese system of frequent movement of the firing battalions, they may consider the back-up launchers as superfluous and an unnecessary liability in respect to transportation requirements. The three additional launchers, which carry missiles in excess of the computers capacity, are an extra burden in time and resources when moving the battalion, and increase the probability of detection from the air.

6. (S) The reduced number of launchers might have a direct bearing on system recuperability. If all three launchers are fired almost simultaneously, the site will be non-operational until the launchers can be reloaded. Re-load time, with transporters available at the site, is a minimum of two minutes.

7. (S) To date, 177 SA-2 sites have been identified in photography in North Vietnam, of which 161 are now capable of accepting equipment. There have been numerous indications, by ELINT or pilot reports, of SAM activity at other locations which have not been identified in photography. The large numbers of usable sites gives the battalions a large flexibility, with an estimated five to eight sites that each battalion can operate from.

8. (S) The identified sites are basically either reveted permanent installations, in the Soviet manner, or the Vietnamese "field" site, which requires a minimum of preparation and is much more difficult to identify when unoccupied. Most of the "field" sites are in the Southern area where there is a greater emphasis on mobility.

9. (S) For missile support, Soviet doctrine calls for a Missile Support Facility for each regiment. Only three support facilities have been identified thus far in North Vietnam, and two have not been observed in use since late 1965. Some support and technical work normally accomplished by the facility is probably being handled at the battalion level, and the airfields almost certainly are exploiting their "untouchable" status to perform much of the support functions, especially for nearby units. However, the requirements for support of distant units, such as

~~SECRET~~

DC-2

Annex C to
Appendix D

~~SECRET~~

those in Vinh. still exists. Some form of shoestring facility, performing minimal functions, could be located in heavily wooded areas and camouflaged against aerial detection.

10. (S) The Soviets claim a 50 percent kill probability for the SA-2 missile system. So far the direct effectiveness of the system in North Vietnam against tactical aircraft is considerably less, amounting to less than three percent kills for missiles fired.

11. (S) Soviet personnel have been present in North Vietnam, as instructors and advisors, since the initial SAM build-up in 1965. They are apparently still presently performing those roles, and also gaining operational experience in an actual combat environment, and observing the effectiveness and deficiencies of the system.

12. (S) There have been numerous reports of Cuban SAM troops being sent to North Vietnam, and of some Cubans being killed by strikes on SAM sites. However, there is presently no evidence to confirm a Cuban SA-2 presence in North Vietnam.

~~SECRET~~

DC-3

Annex C to
Appendix D

~~SECRET~~

ANNEX D TO APPENDIX D

POSSIBLE FUTURE IMPROVEMENTS
IN THE SURFACE-TO-AIR MISSILE SYSTEM

1. (S) Uncertainties

a. Three basic uncertainties surround estimates of possible improvements in NVN SAM defenses:

- (1) Gaps in technical intelligence.
- (2) Uncertainty as to true effectiveness.
- (3) Lack of knowledge of Soviet intent.

b. The first uncertainty is discussed under each SAM system below. The last two uncertainties applies to all potential improvements and our existing knowledge of them. Prior to the employment of the SA-2 in North Vietnam, technical estimates of its effectiveness were for high and medium altitude targets, and the system was held in considerable respect by pilots, commanders, and analysts. These estimates were generally and, it developed, incorrectly applied to tactical aircraft. It is possible, perhaps even likely, that existing estimates of the effectiveness of other SAM systems are similarly in error.

c. The Soviets could choose, or could already have chosen, to introduce improved SAM systems into North Vietnam. The probabilities of this are difficult to assess. As previously indicated, the North Vietnamese (and therefore probably the Soviets) overestimate the effectiveness of the SA-2. Thus, the Soviets may not be dissatisfied with its performance, if they attribute its ineffectiveness to:

- (1) The North Vietnamese.
- (2) Use in a role for which it was not designed.

d. If the Soviets feel strongly that the North Vietnamese have been unable to adequately operate and/or maintain the SA-2, they would be unlikely to make

~~SECRET~~

DD-1

Annex D to
Appendix D

the North Vietnamese the first non-Russian recipients of improved systems such as the SA-3. If they feel that the SA-2 has been ineffective primarily because it was not designed to counter tactical aircraft, then they might decide to supplement the SA-2 defenses with additional defenses, provided these are deemed to be suitable for defense against tactical aircraft.

AP

(3) Possible ability to intercept targets of somewhat lower altitude.

c. Accordingly, it does not appear that introduction of the C-Band FAN SONG would significantly improve NVN air defense capabilities unless introduction of US ECM equipments lagged more than was the case with the S-Band FAN SONG. However, introduction would necessitate introduction of a capability in US airborne equipment to detect and counteract emissions in the new frequency spectrum in the same environment with the SA-2, S-Band system.

4. (S) FAN SONG/FIRECAN Coordination

a. A CHICOM SA-2 site near Kunming and another near Canton have been observed periodically operating with a FIRECAN radar apparently slaved to it. A high altitude photograph of the Canton site shows what could be the FIRECAN in close proximity to the FAN SONG. This combination of radars may be employed against US countermeasures equipments in an attempt to decrease our effectiveness by:

(1) Triggering the automatic jamming equipments with the FIRECAN radar and delaying the FAN SONG radar pulse slightly, thus taking advantage of the countermeasures equipment "dead time" during the cycle in which it is responding to FIRECAN.

(2) Obtaining range data from the FIRECAN radar and limiting FAN SONG radar transmission time to that required for missile launch and guidance.

(3) Illuminating the target with the FIRECAN radar and operating the FAN SONG in a lobe-on-receive mode. Elevation and azimuth data is obtained by the FAN SONG while passively scanning and limiting transmitter time to that required for missile launch and guidance.

d. Such coordination has not been observed either in ELINT or photography in North Vietnam or elsewhere outside of China. If this method of operation is introduced into North Vietnam, its effectiveness, while uncertain, would not be likely to increase US SAM losses by an order of magnitude since the SA-2

system has not proved particularly lethal against tactical aircraft under any circumstance.

5. (S) SA-3

a. The basic operational deployment of the SA-3 suggests that:

(1) The system was designed primarily to supplement SA-2 defenses by providing additional low altitude protection against strategic attack.

(2) Developmental problems were encountered.

b. Subsequently, the SA-3 missile (GOA) was identified as a part of the naval SAM system. The radar for this system (PEEL Group) is somewhat different in appearance and frequencies than the SA-3 radar (LOW BLOW) and might represent an improvement of it. However, this radar has not been detected in the Soviet forces in Germany or East Europe.

c. Should the SA-3 system appear in North Vietnam, it will present a different threat than the S-Band SA-2 system. Although it is a track-while-scan, command-guided system, there are significant differences which are summarized below:

	<u>S-Band SA-2</u>	<u>Estimated SA-3</u>
Guidance Command Frequency	700-850 MHZ	1100 MHZ (Probable)*
Target & Missile Tracking Radar	2900-3100 MHZ	9100-9500 MHZ

* Previously estimated guidance signal 3845-3916 MHZ (BGGP) now evaluated as telemetry; PEEL Group guidance signal may be 2780-2830 MHZ.

~~SECRET~~

Nominal Max Range	19 nm	14 nm @ 30,000 ft. (3g maneuver limit)
Nominal		
Time of flight to:		
10,000 ft. and 5 nm	18 sec.	16 sec.
10,000 ft. and 10 nm	31 sec.	29 sec.
Missile Maneuver Limit	7-9G (Probable)	12 G
Nominal Minimum		
Intercept Altitude	1500-3000	1000
Warhead Weight	420 lbs	120 lbs

d. There is no evidence at present that North Vietnam or the Soviet Union has an operational infrared SAM. While there is evidence that the Soviet Union recognizes the need for a missile like the US RED EYE or CHAPPARAL, no indications of its development have been noted.

~~SECRET~~

DD-5

Annex D to
Appendix D

~~SECRET~~

ANNEX E TO APPENDIX D

NORTH VIETNAM AIR FORCE

1. (S) The North Vietnam Air Force is composed of 233 aircraft. Of these 114 are jet fighters and eight are light jet bombers. The bombers are not believed to have conducted flight operations since summer 1966. There are indications of recent deliveries or recent assembly of jet fighters providing a possible increase in the NVN Air Order of Battle by at least 12 MIG-21s. Sixty six transport aircraft provide a logistic, support, and minimal attack or harassment capability, the latter of which has thus far been utilized against MAROPS without significant success. Small helicopters provide a capability for short haul, light load logistics in and out of unprepared areas. The heavy HOOK helicopter, however, is a long haul, large capacity utility craft and has been used for trips as far as Na San and Dien Bien Phu. A modified HOOK can carry equipment and hardware necessary to establish a SA-2 site.

2. (S) The fighter interceptor force of about 96 MIG-15/17 and 18 MIG-21 includes approximately six of each model which are configured for all-weather operations have aid-to-intercept radar (SPIN SCAN or SCAN ODD). There have been no valid all-weather intercepts noted to date although AI radar has been intercepted during some daytime encounters. The AI radar on the MIG-21 FISHBED D provides a capability to utilize the ALKALI beam riding missile. All models of the MIG-17 and 21 can carry the ATOLL IR homing missile.

3. (S) It is estimated that NVN MIGs fly about 500 sorties per month. Monthly POL requirements for this activity are estimated to be 900-1300 metric tons. Sorties probably initiate from Phuc Yen 80 percent of the time with Gia Lam and Kep accounting for eight and twelve percent, respectively. MIGs are most often sighted within 50 miles of active airfields.

4. (S) Daylight and clear weather to partly cloudy conditions have prevailed in United States/MIG encounters thus far. NVN jets have fired cannon, an estimated 39 AAMs and numerous air-to-air rockets. In 110 engagements, at least 389 US jets have opposed

~~SECRET~~

DE-1

Annex E to
Appendix D

SECRET

about 325 MIGs with a MIG kill occurring in 30 percent of the flights. The United States presently has over a three to one edge in shoot downs, based on pilot claims.

5. (S) GCI control is in evidence in most if not all engagements. MIGs appear approaching both head-on and from the tail. They have been observed coming in from cloud cover, indicative of radar vectored intercepts. About 70 percent of all encounters have taken place within 50 miles of Hanoi.

6. (S) About 100 combat MIG pilots with probably 25 FISHBED pilots are estimated to be taking part in current operations. Probably 50 more pilots are in combat training. In addition, as many as 35 to 45 North Korean pilots are estimated to be in North Vietnam and could take part in defense operations. Their number may increase to 52, a North Korean regiment.

7. (S) Some Soviet pilots probably perform an advisory, test and instructor roles and are not believed to be taking part in encounters with US aircraft.

8. (S) Present jet operations are confined to Phuc Yen, Kep, Gia Lam and occasionally Kien An and Cat Bi. These airfields are capable of supporting a total of about 220 jet fighters. North Vietnam has a limited capability to perform true all-weather operations with a significant number of airborne jets due to the lack of substantial radar control approach facilities. Current airfield construction activity is limited to Bai Thuong which is not yet completed, Hoa Lac, which is capable at limited operations and Kep where a runway extension project is in progress. Kep may be destined to become the second best fighter base in North Vietnam.

9. (S) There are positive intelligence indications that MIGs are being assembled in North Vietnam. While a complete chronology of aircraft shipping crates being photographed at Phuc Yen has not been completed, it appears that shipping crates have been arriving since the fall of 1965 and a shipment of 20-25 MIG-21s may have recently arrived from the Soviet Union. The

SECRET

DE-2

Annex E to
Appendix D

~~SECRET~~

standard FISHBED crate is not in evidence, suggesting that a smaller crate is used for rail shipment with the aircraft dismantled to a greater extent.

10. (S) The MIG-21 FISHBED is a high speed interceptor capable of operating at over 60 thousand feet at speeds of up to 1,150 knots. A zoom climb intercept capability exists to altitudes above 70 thousand. Both the day fighter and all-weather versions are presently in North Vietnam. Both versions can carry AAMs, external bombs and rockets. The all-weather FISHBED has no cannon capability. The MIG-17 is capable of altitudes above 53,000 feet at speeds up to 600 knots. It also is capable of handling AAMs as well as rockets and bombs. The primary target of the FISHBED seems to be the F4C while MIG-17s engage primarily F-105s on strike assignments.

11. (S) North Vietnamese jets have been observed with two basic insignia. Pilot observations indicate either a plain red star or a basic red star and bar similar to CHICOM markings. Photography seems to support a yellow star within a red circle superimposed on a red bar. Some FISHBEDS have been observed with green insignia in addition to the country markings, possibly indicative of a unit designator.

12. (S) Listed below are the names and locations of North Vietnamese airfields, including those under construction, and having runways at least 2,000 feet or more in length:

Bac Can	22-09-07N/105-51-05E	
Bai Thuong	19-54-04N/105-28-22E	(Under construction)
Ban Puoi	21-15-30N/104-39-00E	
Cao Bang	22-39-35N/106-16-19E	
Dien Bien Phu	21-23-35N/103-00-40E	
Dong Hoi	17-30-45N/106-35-40E	
Ha Giang	22-52-47N/104-57-10E	
Cat Bi	20-49-01N/106-43-46E	
Kien An	20-48-29N/106-36-48E	
Bac Mai	20-59-22N/105-50-00E	
Gia Lam	21-02-09N/105-53-24E	
Hoa Lac	21-02-00N/105-30-00E	(Under construction)*
Kep	21-24-00N/106-16-10E	
Kep Ha	21-22-45N/106-39-52E	

*Apparently complete enough for a small contingent of MIG-17s.

~~SECRET~~

DE-3

Annex E to
Appendix D

Lai Chau	22-03-33N/103-09-52E
Lang Son	21-50-08N/106-46-33E
Lao Cai	22-28-53N/103-58-49E
Mong Cai	21-31-15N/107-58-48E
Na San	21-12-46N/104-02-18E
Nghia Lo	21-35-45N/104-30-20E
Phong Tho	22-32-00N/103-21-50E
Phuc Nhac	20-10-12N/106-05-25E
Phuc Yen	21-13-25N/105-48-48E
Phu Tho	21-23-50N/105-12-40E
Than Uyen	21-59-42N/103-55-30E
Tong	21-05-50N/105-28-07E
Vinh	18-43-52N/105-40-28E
Yen Bai	(Presently considered an unidentified military installation and not an airfield under construction)

13. (S) The following is an estimate of the number of aircraft in the categories indicated that could be supported at each airfield. In the case of Phuc Yen, two figures are presented to show the number of light bombers that could be supported in the absence of other aircraft types. No attempt has been made to show numbers derived by combining two or more categories nor does the list include estimates for airfields with runways less than 2,000 feet in length or airfields under construction or extensively damaged and presumed abandoned:

	<u>Jet Fighter</u>	<u>Jet Bomber</u>	<u>Transports</u>
Bac Can	--	--	5
Bac Mai	--	--	10
Cat Bi	30	10	--
Gia Lam	40	--	--
Kep	40	--	--
Kien An	20	--	--
Lang Son	--	--	15
Mong Cai	--	--	5
Phuc Yen	75-90	25-30	--
Tong	--	--	5

14. (S) The number and type of aircraft that are currently being operated at airfields is as follows:

~~SECRET~~

	<u>Phuc Yen</u>	<u>Kep</u>	<u>Bia Lam</u>	<u>Kien An</u>	<u>Cat Bi</u>
MIG 21	13	--	--	--	--
MIG 15/17	32	15	15	--	2
IL-28	6	--	--	--	--
AN-24	--	--	3	--	--
IL-14	--	--	14	--	--
LI-2	--	--	10	7	7
AN-2	--	--	11	6	7
MI-1/4	--	--	12	4	4
MI-6	--	--	3	3	--
UMIG 15	3	--	--	--	--
YAK 11/18	--	--	--	--	14
ZLIN 226	--	--	15	--	--

Note: An additional 32 MIG 15-17s and 2 IL-28s are located in China.

15. (3) While it is assumed that most, if not all major airfields handling jet and large transport aircraft have all-weather landing systems only Bac Mai is known to possess a ground approach control radar (HOME TALK) supported by a traffic control surveillance radar (LONG EYE). Photography reveals that a HOME TALK is possibly located at Phuc Yen and since both type landing aids are compatible with each other, it is possible that a LONG EYE is located there also. To provide initial let-down control there are an estimated seven Ground Control Intercept facilities available.

It is not known whether instrument landing systems are positioned on major airfields. In the absence of HOME TALK and LONG EYE, and where weather conditions are either below minimums or beyond the ability of the pilot to cope with, recovering aircraft would probably be directed to alternate fields hosting precision approach radar or experiencing favorable weather.

The volume of air traffic that could be handled at any given airfield would depend upon many facets of air operations including weather, pilot and controller proficiency, status or availability of approach radars, in-flight emergencies, and the air defense conditions at the moment. Comparing the flight operations of the present Air Order of Battle with existing airfields.

~~SECRET~~

DE-5

Annex E to
Appendix D

SECRET

It is probable that the present traffic load has not overly taxed any airfield conducting launch and recovery operations and that a greater volume could be handled successfully.

SECRET

DE-6

Annex E to
Appendix D

~~SECRET~~

ANNEX F TO APPENDIX D .

COMMAND AND CONTROL

1. (S) For the purpose of air defense command and control, the NVN land mass is considered to be one air defense district. It is believed that the NVN air defense system is closely patterned after those of Communist China and the Union of Soviet Socialist Republics. It is a sophisticated, integrated network of radar sites (EW/GCI/FC), filter centers, communications facilities, command elements and defensive weapons systems (SAM/AAA/aircraft).

2. (S) The Headquarters Air Defense District, Hanoi (JCS 30) is the highest echelon of the command and control structure. (See Tab A). This headquarters is believed to be direct air defense at the national level, to include direction of GCI facilities and possibly controlling fighter aircraft in the Hanoi Zone. At this level all elements of defense, i.e., manned aircraft, SAM, AAA, GCI, and EW radar nets are coordinated. All aircraft tracking data from filter centers are received and acted upon at this headquarters.

3. (S) There are several Air Defense Filter Centers believed to be operating within North Vietnam. These Filter Centers receive all plot data direct from the subordinate detection facilities, perform the necessary filtering, and pass the resultant tracking data to the Hanoi Air Defense District Headquarters, adjacent filter centers, and various weapons system controllers.

4. (S) Air warning units (field radar sites) maintain 360 degrees surveillance, including the detection, tracking and identification of all air activity and report this data to their appropriate filter center. It is estimated that an average time of three minutes is required from initial detection of a hostile aircraft until accurate data is made available to the Air Defense District Headquarters.

~~SECRET~~

DF-1

Annex F to
Appendix D

~~SECRET~~

5. (S) Air surveillance is maintained on a 24-hour basis. Radars at particular sites operate during scheduled periods in accordance with an over-all plan for coverage of North Vietnam. A typical day's schedule might call for several two-hour operating periods for a radar site. The radars are shut down outside of their operating periods and for periodic maintenance. The extensive redundancy of radar equipments within North Vietnam provides sufficient duplication of coverage to allow for crew rest and maintenance without sacrificing radar coverage.

6. (S) Communications links are the vital elements upon which the air defense command and control is dependent. These links tie the field radars to the filter centers and permit passage of warning information up the chain of command. Existing communications probably consist of high frequency radio utilizing manual morse and voice broadcast, point-to-point VHF voice broadcast, land line, and microwave relays. A microwave (R-400) antenna has been identified at Hanoi/Bac Mai Airfield; however, the location of other microwave antennas has not been determined.

7. (S) Surface-to-air missile (SAM) units are organized by regiment and subordinate battalions. It is estimated that there are presently 25-30 SA-2 battalions operating within North Vietnam. Assuming that the SAM organizational structure is based upon the Soviet standard of approximately six battalions per regiment, there are probably four or five SAM regiments in North Vietnam. As in the Soviet system, it is believed that the responsibility for weapons commitment is a matter of standard operating procedure at the SAM regimental level.

8. (S) For fighter aircraft control, there are 11 heavy EW/GCI (BAR LOCK/BIG BAR/TOKEN) type radars identified with North Vietnam. These radars coupled with the FLAT FACE, low-level gap filler radar, provide North Vietnam with an extensive GCI capability in excess of that required for the relatively small number of fighter interceptors in the inventory.

~~SECRET~~

DF-2

Annex F to
Appendix D

~~SECRET~~

9. (S) The RVN air defense command and control procedures and equipments are considered to be undergoing continual modernization and refinement for greater effectiveness. There have been indications of the simultaneous integrated employment of different weapons systems, i.e., SAM/AAA/aircraft. Although this type of coordinated force employment is not the routine, it is an indication of an established capability.

~~SECRET~~

DF-3

Annex F to
Appendix D

~~SECRET~~
COMMAND AND CONTROL STRUCTURE
NORTH VIETNAM AIR DEFENSE SYSTEM

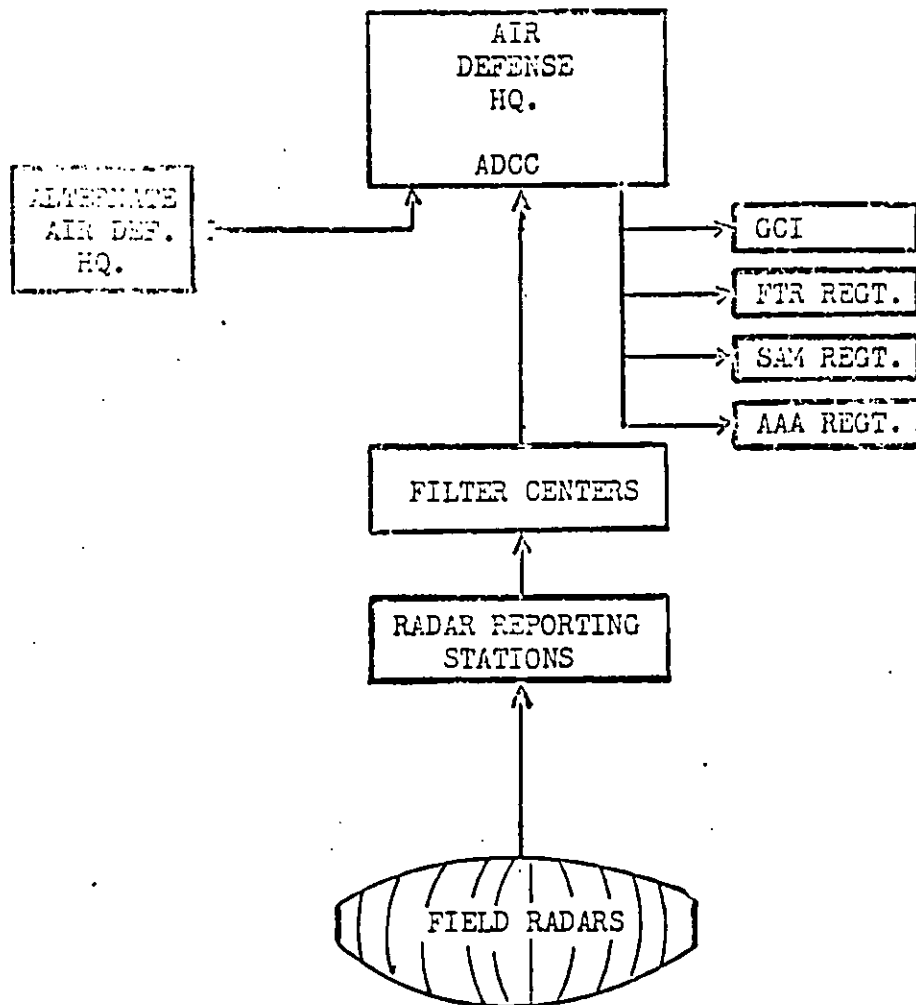

~~SECRET~~

DFA-1

Tab A to
Annex F to
Appendix D

~~SECRET~~

ANNEX G TO APPENDIX C

EFFECTIVENESS OF US OPERATIONS

1. (S) Strike Operations

a. Through December 1966, 19 different early warning radar sites in North Vietnam have been subjected to air attack, many repeatedly. Thirteen of these radar sites subsequently returned to full active status. The isolated stations on the islands of Hon Matt, Hon Nieu, and Bach Long Vi have apparently been abandoned.

b. The effectiveness of strikes against fire control and missile control radars has been difficult to evaluate. Strict EMCON on the part of the NVN air defense personnel suggests an awareness of the SHRIKE missile on the part of the North Vietnamese. Sharp reduction in radiation time, particularly by the FAN SONG radar, has made target acquisition and firing by SHRIKE equipped aircraft difficult. During many instances when SHRIKE missiles have been fired at FAN SONG and AAA fire control radars, the emitter frequently has shut down shortly after launch. The ability of the North Vietnamese to identify the moment of launch or its carrier is uncertain.

c. Assessment of air strike results are based on pilot reports, post strike photo reconnaissance, and ELINT. Smoke and dust frequently obscure the target, aerial photography is rarely able to permit definite identification of radar antennas and tactical redeployment of equipment add to the problems involved in Bomb Damage Assessments (BDA). While ELINT does not provide positive evidence of destruction or damage to radar equipments, the lack of subsequent intercepts from some of the struck sites implies at least some damage. On the other hand, subsequent ELINT intercepts from other sites struck provide indications of either repairable damage or replacement of equipment.

~~SECRET~~

DG-1

Annex G to
Appendix D

~~SECRET~~

d. In summary, the success of air strikes against NVN EW/GCI, fire control, and missile control radars has been, at best, difficult to evaluate. In any event, the introduction of new equipment has probably more than offset any actual hardware losses resulting from attack, and the NVN air warning, ground controlled intercept, and weapon control systems remain intact displaying continued growth.

2. (S) ECM/ECCM Operations

a. Information regarding effects of US jamming on NVN radars is very sparse. It is believed that the overlapping coverage of early warning radars throughout North Vietnam, the limited area of responsibility for each, the frequency diversity among the various radars and the probable availability of information derived from Chinese communist radar coverage offer sufficient duplication to offset all but the most concentrated effort to interfere with this surveillance function.

b. The NVN AAA elements have indicated some effects from US jamming of their fire control radars by displaying certain characteristic patterns of radiation. The degree of jamming success against the NVN AAA elements is not known, however, US ECM operators have reported consistent success in breaking lock-ons of the fire control radars. Jamming against fire control radar sites, especially in breaking the lock-on mode of operation has, on most occasions, appeared to completely degrade the radar's capability to direct accurate controlled fire.

c. SAM crews have been successful in downing hostile aircraft while operating in an ECM environment. Three EB-66 aircraft have been lost to the SA-2 system and one of a pair of EF-10B disappeared under circumstances which might have involved an SA-2 firing.

d. While it is believed that the North Vietnamese are fully aware of the SHRIKE missile and its mission, there is little evidence to indicate that they can identify the aircraft so equipped or the moment of launch. The standard Vietnamese operating practice appears to be an on-again-off-again tactic with the

~~SECRET~~

DG-2

Annex G to
Appendix D

~~SECRET~~

FAN SONG radar. The silencing of FAN SONG radars as aircraft are aligned for launch could quite conceivably be coincidental with this intermittent practice. The precautionary emission control technique has been confirmed by various ELINT collectors. ECM operators have been reporting for some time that FAN SONG signals are up for only short periods, apparently progressing from a dummy load mode of operation directly to transmit in the high PRF mode, resulting in a minimum amount of time between the initial intercept of the signal and missile launch.

e. In summary, it is believed that US jamming activities have been sufficiently effective to force the North Vietnamese to search for counter-countermeasures and actively pursue a course aimed at overcoming these effects. It appears that the over-all air surveillance reporting system has not been degraded to any significant degree due to the overlapping radar coverage and the probable inter-country data exchange.

3. (S) Attacks on EW Radar Sites

a. Through November 1966, there had been at least the following attacks on Joint Chiefs of Staff numbered EW sites:

<u>Site</u>	<u>Total Attack Sorties</u>	<u>Site Status</u>
Mui Ron	166	Active
Ha Tinh	65	Active
Hon Mat	237	Inactive
Quong Khe	44	Relocated
Kim Cuong	8	Relocated
Anh Song	8	Relocated
Bach Long Vi	107	Inactive
Vinh Son	206	Active
Dong Hoi	12	Moved prior to attack
Vinh Linh	40	Active
Cua Lo	106	Destroyed
Mu Duc	15+	Active
Hon Nieu	123	Inactive

~~SECRET~~

DG-3

Annex G to
Appendix D

SECRET

b. This heavy weight of effort is not indicative of a sustained anti-radar campaign but resulted from the fact that a number of the sites are suitable as weather alternates.

4. (S) Attacks on SA-2 Sites

a. Through mid-November 1966, there had been on the order of 200 visually-directed attacks on SA-2 sites. Photographic BDA was obtained approximately 40 times. In only four cases (one a restrike on a previously attacked site) was damage to SAM equipment photographed. In a fifth case, a number of craters in a partially occupied site were visible. Photographic BDA results are summarized below:

<u>BDA Delay</u> <u>After Last</u> <u>Attack</u>	<u>Damaged</u> <u>SA-2</u> <u>Equipment</u>	<u>Craters in</u> <u>Dummy or</u> <u>Unocc Site</u>	<u>Unoccupied</u> <u>No Damage</u>	<u>Total</u>
Same Day	4*	4	7	15
1-7 Days Late	(1)**	5	6	12
1-4 Weeks Late	-	4	6	10
1-5 Months Late	-	-	2	2
Date of Attack	<u>-</u>	<u>2</u>	<u>-</u>	<u>2</u>
	4 (5)	15	21	41

b. The results of the three attacks whose success is positively assessable from photography are summarized below:

* 3 sites, 4 attacks; 4 BDA passes

** Site partially occupied and cratered; no direct evidence of equipment damage

SECRET

DG-4

Annex G to
Appendix D

~~SECRET~~

Photographic BDA

<u>Site</u>	<u>Date</u>	<u>Aircraft</u>	<u>Ordnance</u>	<u>Results</u>
23	7 Nov 65	4 A-4	152 x 2.75" RX 24 x 250# bomb	Guidance vans and 2+ launchers damaged
42	7 Nov 65	4 A-4	24 x 250# bomb	4-6 launchers damaged;
42	7 Nov 65	4 A-4, 1 A-6	34 x 500# bomb 5 x 1000# bomb	destroyed probable damage in guidance area
136	9 Sep 66	20 F-105 13 F-4 8 F-104	Over 30 tons " "	2 transporters destroyed; 2 damaged; 2 probably damaged

~~SECRET~~

DG-5

Annex G to
Appendix D

ANNEX H TO APPENDIX-D

NVN WEAPONS EFFECTIVENESS

1. (S) Over-all

From 7 February 1965 to 31 December 1966, attrition of strike, flak suppressor and armed reconnaissance aircraft over North Vietnam has been 0.33 percent. Average attrition of attack aircraft has slightly but persistently declined. This steady reduction in loss rates has presumably been due to a complex interaction between United States and enemy tactics and equipment effectiveness which is only partially understood. Losses have been overwhelmingly to gunfire with losses to SA-2 and to fighters following in that order.

2. (S) Guns

Over-all direct gun effectiveness has been low; through 31 January 1967 attrition of attack aircraft to guns has been less than three losses per thousand sorties. However, these over-all averages conceal some extremely high attrition rates which are summarized below:

<u>Type of Operation</u>	<u>Sorties</u>	<u>Attrition of attack Sorties to gf</u>
1965 low altitude attacks	370	5.7%
1965 USN attack sorties in Package VI	511	2.5%
April-December 1966, USAF attack sorties in Package VIA	2430	1.4%
April-December 1966, USN attack sorties in Package VIB	3110 (SAR & RESCAP losses excluded)	0.73%

(The marked difference in Navy and Air Force 1966 attrition in Package VI is probably due to the fact that the Navy sorties represent a mixture of strikes on heavily defended targets and armed reconnaissance

~~SECRET~~

on the less-defended coastal fringes while the Air Force sorties were predominantly against heavily defended targets.) Losses as a function of altitude through 30 September 1966 have been as follows:

<u>Altitude of Hit (ft)</u>	<u>Percent</u>
Below 4500 ft	87%
4500-7000 ft	6%
Above 7000 ft	7%

3. (S) SA-2 Effectiveness

a. Over-all SA-2 effectiveness against tactical aircraft through 5 February 1967 has been low: Over 1500 missiles were fired for 34 positive and 12 probable/possible kills. North Vietnamese beliefs as to effectiveness have been more optimistic; they consistently report shoot downs which do not, in fact, occur. US tactics of diving for the ground when sighting missiles may create radar and visual indications of shoot downs which do not occur.

b. The low over-all effectiveness of the SA-2 system has not been obtained uniformly. Against manned aircraft presenting ideal targets, the system has been moderately effective. During the first two months of employment in 1965, for example, the number of SA-2 fired per kill was four. Similarly, when the SA-2 system was first deployed south into the DRV panhandle, during February-April 1966, the number of missiles fired per kill was eight. Finally, against high altitude drones, performance has been far better with an estimated two missiles fired per kill. Most SA-2 kills have occurred at or above 3000 feet.

c. Indirect effectiveness of the SA-2 system appears to have included:

(1) Interference with true armed reconnaissance.

(2) An increase in en route losses to AAA at least for strikes on fixed targets due to the requirements to operate at lower altitudes.

~~SECRET~~

DH-2

Annex H to
Appendix D

~~SECRET~~

(3) Significant reduction in photo coverage due to altitude restrictions for losses.

(4) Restrictions on B-52 operations.

4. (S) Fighter and GCI Direct Effectiveness

a. Basic statistics on the effectiveness of the NVN fighter and GCI system during the period 1 January 1966 - 28 February 1967 and summarized below:

Intercept attempts	Unknown
Encounters	98
US Losses	10 *
NVN Losses	30 **

In addition to the probable intercept attempts a number of MIG sightings which did not evolve into engagements indicates that possible defensive patrols are being flown as part of the NVN defensive tactics.

b. This data indicates that the direct threat from fighter aircraft is low: about seven percent probability of loss given an engagement. Further, the exchange rate is unfavorable to the North Vietnamese; three to one by US pilot reports.

c. An implicit indicator of GCI effectiveness is given by the degree of success in interfering with strike aircraft inbound to or over the target. Data on air encounters are summarized below:

-
- * Excludes one US initiated intercept of prop aircraft.
** Includes probable and possible losses.

~~SECRET~~

DH-3

Annex H to
Appendix E

~~SECRET~~

US Aircraft Mission	1965	1966	Oct 1966 to	
			1966	Jan 1967
TARCAP/BARCAP/ESCORT	5	10	6	15
Strike				
Inbound			8	9
Over Target	1		4	6
Outbound		2	4	2
Uncertain	1		11	10
TARCAP & STRIKE	1			
RECCE/ECM/OTHER	2	4	2	3

d. It can be seen that after mid 1966, encounters with strike aircraft prior to ordnance delivery increased and encounters with CAP decreased. However, after October, encounters with US CAP increased substantially, while encounters with strike aircraft remained constant. This may have resulted from improved US strike tactics, improved NVN GCI, more confidence in MIG pilots, particularly MIG-21s, or all factors combined.

e. Indirect effectiveness of fighter operations may have included:

(1) Some diversion of strike-capable aircraft to BARCAP and TARCAP.

(2) Reduced weapons loads due to carriage of AAM.

(3) Ordnance and fuel tank jettisoning incident to attacks.

f. Although the majority of the losses have been below 5000 feet, there has been substantial exposure above that altitude, particularly in delivery maneuvers against heavily-defended targets. This implies that radar-controlled gunfire has been relatively ineffective in North Vietnam, either inherently or because of

~~SECRET~~

DH-4

Annex H to
Appendix D

~~SECRET~~

existing US countermeasures. Indirect effectiveness of AA defenses has included:

- (1) Avoidance of low altitude attacks.
- (2) Increase in release altitudes and the elimination of multiple-pass attacks.
- (3) Geographic restrictions on aircraft employment.

5. (S) Following is a complete summary of US aircraft combat losses in North Vietnam to various defensive weapons systems as of 6 March 1967:

Ground Fire	392
SAM Confirmed	34
SAM Possible/Probable	12
MIG Confirmed	10
MIG Possible/Probable	2
Other Combat	4
Unknown	<u>30</u>
TOTAL LOSSES	484

~~SECRET~~

DH-5

Annex H to
Appendix D

~~SECRET~~

ANNEX I TO APPENDIX D

AN ANALYSIS OF NVN AIR DEFENSE COMMAND AND CONTROL SYSTEM AS A TARGET SYSTEM

1. (S) Target System

a. General

(1) In compiling suitable data for a detailed target analysis of the NVN Air Defense Command and Control System, available information from Defense Intelligence Agency (DIA), National Security Agency (NSA), National Photographic Interpretation Center (NPIC), Joint Chiefs of Staff, Seventh Air Force (7th AF), and Pacific Command Air Force (PACAF) has been examined. From this examination, it has been determined that much of the existing source data does not permit accurate targeting. Further analysis of the command and control network as an integrated target structure is, therefore required.

(2) The NVN Air Defense Command and Control System is closely patterned after those of the Soviet Union and Communist China. It is a sophisticated, integrated network of radar sites (EW/GCI/FC), filter centers, communication facilities, command elements, and defense weapons systems (SAM/AAA/aircraft). Equipment, technical assistance, and air battle control procedures have been provided by both the Soviet Union and Communist China.

(3) The objective of NVN air defense is to protect selected target areas as well as the major avenues of approach to North Vietnam, and to provide contiguous areas of Communist China with extended early warning and tactical information.

(4) The land mass of North Vietnam is organized into one national air defense district with headquarters in Hanoi. This headquarters not only implements national defense air plans

~~SECRET~~

DI-1

Annex I to
Appendix D

and policies, but also directs and coordinates actual air defense operations within North Vietnam.

b. Target Installations

(1) Headquarters Facilities

(a) Hanoi Military Headquarters, NVN Air Defense District, JCS 30, 21.01.50N/105.50.40E. This is the only targeted air defense headquarters facility in North Vietnam. It includes the supreme staffs responsible for implementation of coordinated air defense plans at the national level, as well as the main operational control center for direction and coordination of actual air defense operations within North Vietnam. As a minimum, the headquarters directs air defense in the Hanoi Zone, including ground control intercept facilities and possibly, fighter aircraft. In addition, it is believed to direct air defense at the national level and control assignment and disposition of AAA units of regimental and/or battalion size. All radar reports from filter centers are received and acted upon at this headquarters.

(b) Subordinate headquarters-type command and control facilities are believed to exist at other key locations, such as Phuc Yen Airfield and Hanoi/Bac Mai Airfield; however, precise identification of facilities, functions, and location to allow targeting application is not available.

(2) Communications Facilities

(a) Telecommunications facilities in North Vietnam consist of telephone/telegraph open wire line network connecting principal cities and town, point-to-point radio communications facilities, and radio broadcasting facilities. The open wire lines are not considered good targets because they are extremely difficult to locate and can be readily repaired if damaged. However, the radio communications facilities do provide suitable targets which are highly vulnerable to air strikes.

(b) Five communications facilities are included in the present Joint Chiefs of Staff Target List, and two of these are considered inactive as a result of air strikes. The remaining three facilities comprise 80 percent of the Joint Chiefs of Staff targeted communications capacity and have not been subjected to air strike. These facilities are:

<u>TGT NO.</u>	<u>NAME</u>	<u>SIGNIFICANCE</u>
66	Hanoi Intl Radcom XMTR Dai Mo (205910N/ 1054600E)	This is the largest and best equipped radio transmission facility in North Vietnam. Believed to serve both military and civilian needs. Focal point for international radio communications. Probably used for communications to overseas areas like Soviet Union, Communist China, and Cuba.
66.1	Hanoi HF Telecom Site PHUC COC (205145N/ 1055332E)	Based on its proximity to Hanoi, antenna configurations, and size, this facility is important in the NVN telecom scheme. Antenna orientations provide 360 degrees coverage. Although the power(s) and frequencies are not known, physical appearances indicate a capability to serve all sections of NVA and VC or Pathet Lao forces, as well as

<u>TGT NO.</u>	<u>NAME</u>	<u>SIGNIFICANCE</u>
66.1		regions in southern Communist China. This could serve as a SIGINT site or as an international shortwave radio broadcast station.
67	Hanoi Intl Radcom Rcvr San Dong (210251N/ 1054132E)	This is the largest and best equipped radio receiving station in North Vietnam. Believed to serve both military and civilian needs. Focal point for reception of international radio communications. Used for long range radio receiving from areas like Soviet Union, Communist China, and Cuba.

(3) Weapons Systems and Support Facilities

(a) SAM Facilities

1. It is estimated that there are 25-30 SA-2 battalions operating within North Vietnam. The exact locations of these battalions at any given time is uncertain because of the high degree of mobility of the SAM system. As of 24 March 1967 there are 161 existing SAM sites which are capable of receiving and employing missiles. Since the daily locations of the SAM battalions cannot be accurately predicted, the SAM sites do not present suitable preplanned targets. However, daily SAM activity indications from ELINT, pilot, and photographic sources showed an average of nine

known sites active per day (during November and December 1966). It is possible that ground alert defense suppression aircraft responding to daily SAM activity indications on a real-time basis could be employed against those sites indicating activity.

2. There are three known and two suspect fixed SAM assembly and checkout facilities in North Vietnam. Of the three known SAM support facilities, two are in the Haiphong area and one is in the Hanoi area. Both of the suspect facilities are in the Hanoi area. Following is a listing of these facilities:

<u>TGT NO.</u>	<u>NAME</u>	<u>SIGINIFICANCE</u>
JCS 65.8	Hanoi SAM Spt Facility (204458N/ 1053510E)	This is the first confirmed SAM support facility in North Vietnam. It is located within 25nm of 23 known SAM sites. As a result of US air strikes, late December 1966 BDA indicates the capacity of this facility to be reduced by approximately 48 percent. This facility is currently believed to be inactive.
	 Haiphong SAM Spt Facility (204400N/ 1063518E)	This is the second confirmed SAM support facility in North Vietnam. It is located within 25nm of 32 known SAM sites. Late December BDA indicates this facility has been approximately 75 percent destroyed. This facility is currently believed to be inactive.

AF

~~SECRET~~

TGT NO.

NAME

SIGNIFICANCE



Haiphong SAM
Spt/Assembly
Area
(205622N/
1062801E)

This is the third confirmed SAM support facility in NVN. Located approximately 13nm WNW of Haiphong, this facility greatly improves the SAM support and servicing in the Haiphong area.

Canh Nam
Suspect Spt
Facility
(213249N/
1060553E)

Located approximately 33nm NNE of Hanoi, this facility is in a strategic position to provide rapid support to SAM sites in the Kep-Thai Nguyen area.

Gia Lam A/F
Suspect Spt
Facility

There have been numerous reports and photographs of various pieces of SAM equipment at several locations on Gia Lam A/F. Although the actual support facility buildings and equipment have not been identified, there is sufficient evidence to indicate a support function.

3. Transient storage and staging of SA-2 missiles and missile associated equipment being deployed to other sites has been detected along the streets of urban areas, on athletic fields, in various military installations, and at agricultural facilities. The fleeting nature of deploying missile equipment precludes preplanned targeting.

~~SECRET~~

DI-6

Annex I to
Appendix D

(b) Aircraft and Airfields. The number of air defense aircraft is constantly changing depending upon deployments in and out of country and upon combat attrition; therefore, reference to the most recent order of battle for current figures is necessary. As of 16 February 1967, there were 114 air defense fighter aircraft reflected in the DIA Aircraft Order of Battle for North Vietnam. Of these, 32 MIG-15/17 aircraft are estimated to be based in China at Yunnani Airfield, and 82 fighters (64 MIG-15/17 and 18 MIG-21) are located at four airfields within North Vietnam which are capable of sustaining jet operations. Two additional airfields are capable of supporting limited jet operations. Those airfields are as follows:

<u>JCS NO.</u>	<u>NAME</u>	<u>SIGNIFICANCE</u>
3	Hanoi/Gia Lam Afld	International airport of North Vietnam. Jet fighter capable. Transport aircraft assigned. 6600'x90' concrete runway, storage and administration buildings, hangars, barracks, POL, extensive aircraft revetments. Used by MIG-15/17s.
6	Phuc Yen Afld	Primary NVN tactical airfield. MIG-15/17/21s, IL-28s assigned. 9170'x205' concrete runway, hangars, storage, and administration buildings, barracks, POL storage, dispersed revetments. Jet maintenance facilities.

<u>JCS NO.</u>	<u>NAME</u>	<u>SIGNIFICANCE</u>
8	Haiphong/ Cat Bi Afld	Primary NVN air transport base. 7900'x170' concrete/asphalt runway, storage, and maintenance buildings, hangars, POL storage, extensive revetments. Used by MIG-15/17s and by helicopters.
9	Haiphong/ Kien An Afld	5900'x140' concrete runway. Administration and storage buildings, barracks, POL storage, extensive revetments. Limited jet capable. Used by light transports and by MIG-15/17s.
9.1	Kep Airfield	5975'x155' concrete runway. Storage buildings, barracks, POL storage, extensive revetments.
---	Hoa Lac Afld	Newly identified operational airfield. Runway is estimated to be 7000-8000 feet in length. Airfield facilities remain under construction; however, March photography showed 5 MIG-15/17 aircraft.

(c) AAA Defenses. As reflected in the PACAF AIS-3D, Antiaircraft Order of Battle, North Vietnam, 2 February 1967, there are 7067 AAA weapons in North Vietnam. Due to the tremendous numbers and because of the

extreme mobility of these Weapons, it is not believed practical to consider targeting the AAA system per se. However, selective targeting of specific AAA defenses in support of other planned missions in a given target area is practical.

(4) Radar Facilities

(a) This category considers individual pieces of radar equipment as well as those principal elements of the command and control system that receive, evaluate, and/or disseminate aircraft tracking data. The present estimated flow of data is from the initial detection by a field radar site, to a radar reporting station, to an air defense filter center where the data is simultaneously relayed to adjacent filter centers, the Hanoi Air Defense District Headquarters (JCS 30), and to various weapons system controllers. Positive identification of responsible command elements is not known; however, it is believed the primary authority for coordination, control, and weapons commitment is presently retained by the Hanoi Air Defense District Headquarters.

(b) The over-all North Vietnam radar command and control network does not present a target structure that is well-suited to preplanned target application. There is a multiplicity of equipment types which provide an extensive redundancy of functional capability. The large numbers, high degree of mobility, dispersed deployment, and relatively small physical size of the individual pieces of radar equipment make targeting of the entire radar system highly impractical. However, targeting of selected key elements of the system such as radar reporting stations, filter centers, Ground Control Intercept (GCI) sites, and their associated point defenses is believed feasible. The following presents available information relative to these key elements:

1. Present estimates indicate there are several radar filter centers operating within North Vietnam. These centers receive the aircraft tracking data from the radar reporting stations, filter the data, and pass it along to higher echelons of command, adjacent filter centers and to weapons systems controllers. Accurate positional data to permit conventional weaponeering is presently available for two of these filter centers:

<u>NAME</u>	<u>COORDINATES</u>
VINH (CUONG GIAN)	184125N/1054120E
NAM DINH	202446N/1061003E

2. At least seven primary GCI sites are operating within North Vietnam. Accurate positional data and equipment identification to permit targeting is available on six of these sites. One known site near Phuc Yen has been shifted to a new location which is undetermined. The six known positions are:

<u>NAME</u>	<u>COORDINATES</u>
HANOI/BAC MAI	205928N/1055005E
KEP	212114N/1061717E
PHUC YEN	211357N/1055307E
HA DONG	205955N/1054400E
CHUC SON	205620N/1054255E
THUONG CHE	205800N/1055825E

3. There are an undetermined number of radar reporting stations passing aircraft tracking data received from the field radar sites. Analysis to date has failed to provide positional data accurate enough to permit targeting of these facilities.

~~SECRET~~

4. In addition to the above targets, there are eight early warning (EW) radar sites for which suitable targeting data is presently available.

<u>NAME</u>	<u>COORDINATES</u>
VINH LINH	170519N/1065930E
DONG HOI	172945N/1063545E
PHU THO	212303N/1051126E
HOA BINH	203807N/1051336E
ANH SON	185410N/1051550E
YEN LAI DONG	190243N/1053411E
BAI THUONG	195344N/1052248E
HAIPHONG	204850N/1064421E

(c) The present Joint Chiefs of Staff Target List for North Vietnam reflects five strategic coastal warning radar sites. These radar sites are: Hon Matt Island Radar Site (67.12), My Duc Radar Site (67.8), Hon Nieu Island Radar (67.9), Bach Long VI Island Radar Site (67.19), and Vinh Son Radar Site (67.2). Each of these sites has been subjected to air strikes. Late December 1966 BDA indicates the radar strength at the first three sites to be 100 percent destroyed and the last two sites to be more than 60 percent destroyed.

2. (S) The Effects that Destruction of a Certain Percentage of the Target System will have on the Enemy's Capabilities

a. General

(1) Because of the vastness of the over-all NVN Air Defense Command and Control System, certain elements of the structure are more vulnerable to destruction than other elements.

~~SECRET~~

DI-11

Annex I to
Appendix D

The structure ranges from the basic field radar sets to the weapons systems being employed. It would be impractical to attempt to destroy each rudimentary part of such a diverse system. For example, there are hundreds of individual pieces of radar equipment and thousands of individual AAA weapons which singly do not warrant targeting consideration. However, destruction of select elements of the system is feasible and would certainly have a degrading effect on over-all North Vietnam air defense capabilities.

(2) From a psychological standpoint, the destruction of certain elements of the command and control network would have a significant disturbing effect. For example, radio communications are used extensively for communication with remote areas, and the denial or disruption of normal radio broadcasting/receiving facilities would have an adverse effect on the general population.

b. Headquarters Facilities

(1) The Hanoi Military Headquarters North Vietnam Air Defense District (JCS 30) is the highest echelon in the Air Defense Command and Control structure. Destruction of the headquarters facilities, equipment, and personnel would result in the loss of air defense direction and early warning control at the highest level. An attendant loss in continuity and coordination of North Vietnam air defense operations would certainly be evidenced if control functions had to be spread among various subordinate command entities.

(2) Collateral effects of facility destruction: An air attack would cause an estimated 60 military casualties in the target area, and light damage and 25 military and 25 civilian casualties in the surrounding area.

c. Communications Facilities

(1) The open wire telephone/telegraph lines are not particularly susceptible to air attack.

~~SECRET~~

Effects realized from attacking open wire lines would be transient, since rapid repair could be easily accomplished. However, destruction of main radio communications facilities would force the North Vietnamese to utilize alternate facilities, probably mobile radio communications equipment, and communications for the North Vietnamese would be seriously degraded.

(2) Of the original total capacity of the JCS targeted communications facilities, 20 percent has been destroyed or inactivated by air strikes. The remaining 80 percent capacity is at three principal installations which had not been attacked as of 19 January 1967. These facilities and their respective Joint Chiefs of Staff targeted capacities are as follows:

<u>TGT NO.</u>	<u>NAME</u>	<u>PERCENT OF JCS TARGETED CAPACITY REMAINING</u>
66	HANOI INTL RADCOM XMTR DAI MO	40
66.1	HANOI HF TELECOM SITE PHUC COC	20
67	HANOI INTL RADCOM RCVR SON DONG	20
	TOTAL	80

(3) Destruction of these facilities would eliminate the total Joint Chiefs of Staff targeted communications capacity of North Vietnam, disrupt the NVN international radio communications, and possibly cause overloading of other radio transmitting and receiving facilities in the Hanoi area. Further, if JCS 66.1 is being used as a SIGINT facility, its destruction would seriously hamper NVN capability, as other installations of this type are not known to exist. Broadcasting of propaganda items to the general public would be curtailed and the volume of international communications between North Vietnam and other countries would be severely reduced.

~~SECRET~~

DI-13

Annex I to
Appendix D

(4) Collateral effects of facility destruction

(a) JCS 66. Attack would cause an estimated five military and two civilian casualties in the target area with no damage or casualties expected in adjacent areas.

(b) JCS 66.1. Attack would cause an estimated five military casualties each in the target area and the surrounding area. No collateral damage is expected in adjacent areas, and no civilian casualties are estimated.

(c) JCS 67. Attack would cause an estimated three military and one civilian casualties in the target area with no damage or casualties expected in adjacent areas.

d. Weapons Systems and Support Facilities.
Destruction or neutralization of the NVN defensive weapons systems would provide a favorable operating environment for our air strike interdiction forces.

(1) Aircraft and Airfields

(a) MIG supporting capabilities would be eliminated by destruction or neutralization of four of the six listed facilities. Denial of Phuc Yen, Hanoi/Gia Lam, Haiphong/Cat Bi and Kep would eliminate those facilities which are capable of supporting sustained jet operations. Similar destruction of the facilities at Haiphong/Kien An and Hoa Lac would preclude even limited jet operations. Elimination of the MIG threat by destruction of the supporting bases would permit greater flexibility and economy in US air operations through a reduction or elimination of the sorties now committed to the MIGCAP role. MIGCAP sorties have averaged about one-third of total sorties flown.

(b) Without the six jet capable airfields there would be no in-country MIG threat; however, the possible use of Chinese Communist

~~SECRET~~

airfields in close proximity to the NVN border for MIG support and launch bases should not be precluded. Destruction or denial of the NVN facilities would limit the strike range of China based aircraft and would preclude their recovery at those bases.

(c) The locations of the listed airfields in or near urban areas would probably subject the adjacent civilian communities to some minor collateral damages and to minimal casualties. Effects of the destruction or denial of the individual facilities (including probable civilian casualties under daylight alert conditions) are as follows:

1. JCS 3, Hanoi/Gia Lam Airfield. Denial would preclude use of one of the principal transport bases in North Vietnam and would deprive North Vietnam of one of six jet capable airfields. It would also reduce the capacity for handling international air traffic, thereby making more difficult the air movement of foreign specialists and some critical items. Estimated civilian casualties: five.

2. JCS 6, Phuc Yen Airfield. Successful attack would deprive North Vietnam of its primary tactical airfield and would considerably reduce the NVN Air Order of Battle (AOB) by destruction of parked aircraft including the bulk of the MIG-15/17/21 inventory. A concomitant reduction in the NVN air defense capability would result. Estimated civilian casualties: None.

3. JCS 8, Haiphong/Cat Bi Airfield. Successful attacks would significantly reduce NVN air capability by the elimination of the primary transport base and probable destruction of parked transports.

~~SECRET~~

DI-15

Annex I to
Appendix D

4. JCS 9, Haiphong/Kien An Airfield. Destruction would further reduce the limited NVN air transport and air logistic capabilities. Estimated civilian casualties: Two.

5. JCS 9.1, Kep Airfield. Expected damage levels would reduce NVN air defense capabilities by the probable destruction of assigned fighters and the reduction of facilities supporting them. Estimated civilian casualties: None.

6. Hoa Lac Airfield. Successful attack would reduce NVN air defense capability by elimination of a limited jet capable airfield as well as destruction of assigned aircraft. Estimated civilian casualties: None.

(3) SAM/AAA

(a) Because of the large numbers and fluid nature of the SAM and AAA defenses, it is not believed feasible to destroy these systems per se. However, destruction of some SAM/AAA sites on a selective, real-time basis is reasonable.

(b) Attacks against SAM/AAA targets should be directed against the associated radar missile control elements. Destruction of the missile control system is far more practical than attempting to destroy the actual weapon itself.

1. In the case of a SAM site target, destruction of the FAN SONG missile control radar would render the site inoperative until such time as the FAN SONG could be replaced or repaired.

2. Destruction of the AAA fire control radar does not totally neutralize the weapon system as in the case of SAM system. However, an attendant loss in firing accuracy would be realized, since the AAA

would have to be employed optically. The loss of radar fire-control would also seriously degrade or negate the capability of these weapons during periods of low visibility and darkness.

(c) Destruction of the SAM support facilities would have a serious impact on the employment of SAMs in North Vietnam. The SAMs must be assembled and serviced prior to delivery to the site locations; therefore, destruction of the support facilities would reduce the capability for dissemination and resupply of missiles.

e. Radar Facilities

(1) The destruction of selected key elements of the radar network, such as filter centers, prime EW/GCI sites, and radar reporting stations, would have a serious degrading effect upon the over-all continuity of the NVN Air Defense Command and Control System. This destruction would undoubtedly cause a critical disruption of the flow of aircraft tracking data and would increase the probability of survival for our strike aircraft. Also, since these are the major points for receiving and passing radar tracking data, their destruction would force the North Vietnamese to rely upon alternate systems with lesser effectiveness, thus enhancing our strike effort.

(a) Filter Centers. Destruction of the two filter centers for which suitable targeting data is available would seriously impair the normal flow of aircraft tracking data and would probably create overloading at the remaining centers. It is believed that alternate procedures probably exist whereby the surviving filter centers could assume at least partial inputs from the radar stations normally reporting to the destroyed facilities.

(b) GCI Sites. Destruction of primary GCI radar installations would significantly reduce the effectiveness of the MIG fighter force. The simultaneous integrated employment of MIG and SAM/AAA defensive systems would be

greatly degraded. The attendant reduction in the number of MIG encounters would not only increase our aircraft survivability, but would also enhance our ordnance-on-target capability. Since any one of the sites has sufficient range for GCI control over the entire Haiphong-Hanoi-Yen Bai sector, destruction of all facilities is necessary to effectively neutralize the over-all capability.

(c) EW Sites. The destruction of those EW sites for which suitable targeting information is available would cause a reduction in the NVN aircraft warning capability. However, because of the extensive redundancy of equipment, the system could sustain considerable equipment and personnel losses and still make significant contributions to the air defense effort.

(2) All of the radar facilities are probably manned by military units and are normally removed from the urban areas; therefore, resultant casualties would be military personnel. GCI sites are the exception to this; Three of the GCI sites (Hanoi/Bai Mai, Phuc Yen and Kep) are situated near airfields, and the other three are located within 10nm of Hanoi. Therefore, attacks against these sites could result in some civilian casualties.

3. (S) Effects of Destruction Upon Capability to Continue and Support Hostilities in South Vietnam

a. The only aspect of the NVN Air Defense Command and Control System that would have a direct bearing on military operations in South Vietnam is the communications facilities. Destruction of the targeted communications facilities would have both political and military impact. The transmission of anti-American propaganda to South Vietnam and neighboring countries would be greatly reduced and possibly eliminated. Military communications with the Viet

~~SECRET~~

Song and NVN regular units operating in South Vietnam would be disrupted immeasurably. This could cause a lack of coordination of effort on the part of these operational units and would force the North Vietnamese to use alternate tactical systems of communications, probably with degraded effectiveness.

b. Indirectly, the destruction or neutralization of the NVN air defense system would provide US strike aircraft with a favorable operating environment. This would greatly enhance our interdiction effort and probably result in a reduction of the over-all NVN support capability in terms of men, supplies, and equipment.

4. (S) Estimated Time to Complete Targeting Analysis

a. Detailed targeting analysis has been accomplished for Joint Chiefs of Staff numbered targets. For other targets, the approximate time to accomplish detailed targeting including narrative target description, area defenses, photography, personnel casualties, and aircraft/weapons requirements is:

4 hours for each EW/GCI site
4 hours for each filter center
8 hours for each airfield

b. Applying these production requirements to the current order-of-battle and target structure, it is estimated that 380 man-hours are required to provide complete targeting. The estimated production times would be reduced by half if the targeting data is briefed to include only target location, photography, and defenses. In addition, the positional accuracy on some targets must be refined prior to detailed targeting and weaponeering.

c. Time estimates do not include routine administrative time for printing and disseminating the target information sheets. Production times are valid under conditions of singular effort being directed to the task with other requirements in standby.

d. SAM and AAA sites have not been considered for targeting due to the mobility and changing status of occupancy.

~~SECRET~~

DI-19

Annex I to
Appendix D

ANNEX J TO APPENDIX D
PERSONNEL AND TRAINING

1. (S) Personnel

a. The personnel strength manning the North Vietnamese Air Defense System is currently estimated to be 83,000 or about 20 percent of North Vietnam's military strength. An additional 27,500 personnel are estimated to be involved indirectly in NVN Air Defense. Air Defense support from foreign nations is estimated as follows:

SOVIET	700-	750
CHINESE (AAA)	9,000-	13,500
NORTH KOREAN (Pilots)		<u>50</u>
	9,700-	14,300

b. The total of all personnel involved directly or indirectly is 120 to 125 thousand. It is estimated that 25-30 battalions are active. They operate in the following areas: Hanoi, Haiphong, Phuc Yen and Vinh. Morale is felt to be generally high among the Air Defense teams. Most NVN ground force personnel are basically of a peasant stock, quite adaptable, and accustomed to hardships.

2. (S) Training

a. The General Directorate for Military Training and the General Political Directorate, which operate on the same level as the General Staff, are ultimately responsible for training all elements of the NVA.

b. During the spring of 1965, under the pressure of US air strikes, the NVN government probably decided to bring in Soviet SAM technicians to train the North Vietnamese rather than await the return of personnel who were reportedly undergoing SA-2 training in the Soviet Union.

c. Despite the probable increased Soviet efforts since mid 1966, no apparent improvement in SAM performance has been noted. This could well be

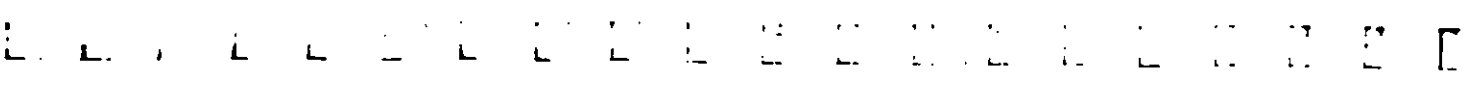

~~SECRET~~

due to one of the following factors:

- (1) Friction between Soviet and NVN crews.
- (2) The language barrier between the two nationalities.
- (3) The intense nationalist feeling of the North Vietnamese and their inherent mistrust of foreigners.

This has been evidenced in the two schools of thought which seem to be controlling the SAM defenses in North Vietnam . . . the Soviet school in the Red River Delta which adheres to the standard SAM operating procedure which apparently insists on disregarding standard procedures moving frequently and using the system as a very expensive sniper.

d. As far as methodology is concerned, it does appear that the NVN crews are following the Soviet method of operations.

e. Although there has been some indications of coordination between SAM/AAA and fighters by the North Vietnamese, the pressures of daily hostile air activity have not afforded them the leisure time to organize effectively for mixed weapons usage or to train in the environment.

f. One of the first requirements for the conduct of sophisticated or nonstandard SAM operations would be training. Current indications are that the majority of the training of air defense crews would be toward achieving proficiency in standard SAM procedures and system fundamentals. A concerted training effort aimed at improving radar operations is evidenced in an improved NVN capability to counter the ECM threat.

g. Considering all of the available evidence it seems that the North Vietnamese, under probable Soviet tutelage, are still in the process of mastering the fundamentals of the SA-2 system and that they are not yet capable of conducting sophisticated or nonstandard SAM tactics on their own.

~~SECRET~~

DJ-2

Annex J to
Appendix D

~~SECRET~~

h. With respect to aircraft maintenance in North Vietnam, this appears to be almost entirely a Soviet undertaking. Training of North Vietnamese to assume this function can be assumed.

i. From now through FY 70, training and technical assistance from the Soviet Union and Communist China is expected to continue and intensify in proportion to US and South Vietnamese prosecution of the air and ground war effort. Primary source of pilot training will be the Soviet Union as will be the introduction of additional or new fighter aircraft. SA-2 training is expected to continue in an "on-the-job" basis with nonstandard SAM tactics being employed to a greater extent. Introduction of the C-band SA-2 or SA-3 is not considered likely from now through FY 70 since none of the Bloc nations have SA-3. This would bring in more Soviet technicians than North Vietnam desires and require additional training and money and at the same time subject the SA-3 system to analysis by the United States. Until the Soviets can be assured that the S-band SA-2 system is being effectively used in North Vietnam, the advantage to be gained by the introduction of a new system into North Vietnam would not seem to compensate for the risks involved.

j. Looking ahead to FY 70 it does not appear likely that the North Vietnamese will appreciably increase foreign in-country assistance. The inherent mistrust of foreigners on the part of the North Vietnamese and their intense nationalistic feeling would seem to preclude an appreciable increase in foreign nationals in North Vietnam except under extreme circumstances even though such assistance has been offered by the Bloc Nations.

3. (S) Pilot Training

a. As modern and complex aircraft are introduced into the North Vietnamese Air Force, the requirement to support, control and operate these aircraft focuses attention on NVN air crew and technical training programs.

b. At present there is no firm evidence of the nature and scope of such programs. As early as

~~SECRET~~

DJ-3

Annex J to
Appendix D

~~SECRET~~

1955 the North Vietnamese embarked on an air training program similar in many respects to those of other emerging nations. There seemed to be three phases: First, a limited basic pilot training program in North Vietnam; second, the dispatching of personnel-first to Communist China and then to the Soviet Union-for flight crew and support personnel training; and third, more advanced instruction in North Vietnam initially under the auspice of Communist China but more recently the Soviet Union.

c. Little is known of the duration of the Communist China sponsored flight training program but it was no doubt long enough to check pilots out on transport aircraft.

d. The first reports of Soviet involvement in the NVN pilot training program were received in 1962. The student pilots were reported to be 20 to 27 years old and to have strong Communist leanings. The training program was reported to last from three to five years including jet training and culminating in MIG-21/FISHBED and IL-28/BEAGLE checkout. The length of the training program is due to the fact that the North Vietnamese have never specialized in aviation and a great deal of time is required to impart the knowledge of modern military technical equipment to them.

e. The number of North Vietnamese in all phases of air training in 1963 reportedly totaled 300 to 400 with 100 of these being student pilots and the remainder involved in maintenance and the air crew training. From 1963 to 1966, the program most likely emphasized the transition of pilots into higher performance aircraft rather than an appreciable increase in numbers of trainees. Based on recent AOB, the current ratio of pilots to fighter aircraft is about two to one.

f. There are indications of a relatively good maintenance capability and minimally adequate flying time for maintaining MIG pilot proficiency. However, when the over-all MIG flying activity is

~~SECRET~~

DJ-4

Annex J to
Appendix D

~~SECRET~~

measured against the extent to which they have countered US air operations, there seems to be a lack in the broad concept of how best to use the fighter force which gives all indication of being operationally ready.

g. Based on most recent flight activity, NVN pilots are expected to become more aggressive in their engagements with US aircraft particularly reconnaissance aircraft.

h. Current estimates are that there are 124 NVN pilots in North Vietnam. Of this total, 35 are probably qualified in MIG-21s.

i. Based on a daily sortie rate of 15 per aircraft, it is estimated that pilots in North Vietnam are averaging about five hours per month flight time.

~~SECRET~~

DJ-5

Annex J to
Appendix D

L L

CONFIDENTIAL

ANNEX K TO APPENDIX D

WEATHER FACTORS

1. (C) Weather affects aircraft combat operations chiefly by its interaction with enemy defenses. As enemy defenses increase in effectiveness, the effect of weather on successful air operations becomes increasingly important.

2. (C) The climate of North Vietnam is monsoonal in nature but is modified by the country's topography and geographic position. Generally speaking, the climate is characterized by two major seasons: the southwest monsoon (mid-May to mid-September) and the northeast monsoon (November through February). There are two short transitional seasons between the two monsoonal periods. (See TABs A through D)

3. (C) The two major topographic influences affecting North Vietnam's climate are first, the low-lying delta regions and second, the mountains. The effects of high winds, storm tides and river flooding are easily felt in the delta region. The mountains, particularly the Chaine Annamitique, exert an important climatic effect in blocking most air flow during the southwest monsoon and in precipitating large amounts of moisture during the northeast monsoon. The orientation of this same mountain chain causes a decided variation in the North Vietnam precipitation pattern during the northeast monsoon with maximum rainfall received during July and August north of Thanh Hoa (19° 48'N, 105° 47'E) and maximum precipitation south of that area during September and October.

4. (C) Mean cloudiness is high throughout North Vietnam and is generally most extensive near the coast and least in the northern and northwestern portions of the country. Aircraft flying at high altitudes over North Vietnam would encounter greatest cloudiness from January through April and least cloudiness can be expected from September through November. This latter period is therefore the best time of the year for conducting most air-to-ground operations. The excessive low cloudiness which covers

CONFIDENTIAL

DK-1

Annex K to
Appendix D

CONFIDENTIAL

North Vietnam throughout most of the year constitutes a definite hazard to low level operations due particularly to the necessity to maintain visual reference with the ground in order to evade SA-2 missiles.

5. (C) In general, surface visibility is fairly good during most of the year except during the periods of prolonged foggy weather which are prevalent during the northeast monsoon from November through February. This is particularly so over the delta region, the coastal plains and the highlands east of the Red River. Unfavorable visibility conditions exist throughout the area most frequently in the early morning hours when fog reduces visibility below two and one-half miles. Conditions improve as the day progresses and most favorable visibilities occur by mid-afternoon. In the southern half of the area the worst period for conducting air-to-ground operations is the autumn transitional period. In general, visibility for low level air operations would be best during the latter part of the morning during the period of the southwest monsoon.

6. (C) Typhoons and severe thunderstorms are experienced in North Vietnam. On the average, two typhoons per year hit North Vietnam entering the Gulf of Tonkin from the South China Sea and bringing widespread low cloudiness, heavy precipitation and high winds. While typhoons are a threat from as early as March into the first part of November, severe thunderstorms occur throughout the year and are characterized by heavy rain, turbulence, hail, and strong gusty winds.

7. (C) Since the North Vietnamese know in general what our weather minimums are, they can expect and prepare for air attack on days with favorable flying weather. Listed below are typical weather minimums required by tactical commanders for visual ordnance delivery in selected areas of Southeast Asia:

Hanoi	5 mi.	10,000 ft.
Vinh	5 mi.	8,000 ft.
Da Nang	5 mi.	1,500 ft.
Saigon	5 mi.	1,500 ft.
Laos	5 mi.	1,500 ft.

CONFIDENTIAL

DK-2

Anrex K to
Appendix D

AIR OPERATIONS—SPRING TRANSITION (MAR-APR)

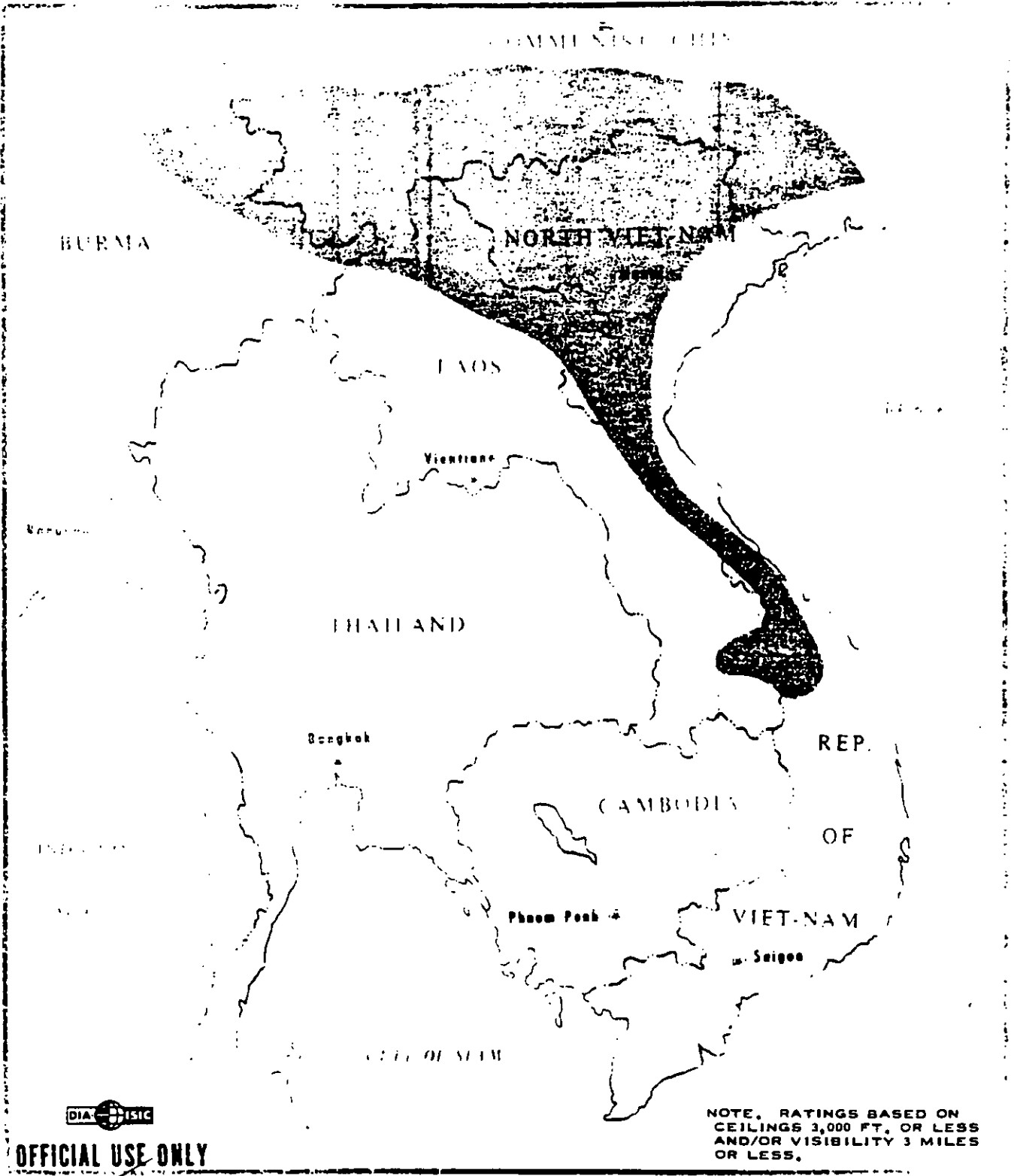

- POOR—OPERATIONS RESTRICTED MORE THAN 60% OF THE SEASON
- FAIR—OPERATIONS RESTRICTED BETWEEN 30% AND 60% OF THE SEASON

- GOOD—OPERATIONS RESTRICTED LESS THAN 30% OF THE SEASON

DKB-1

Tab B to
Annex K to
Appendix D

AIR OPERATIONS

SPRING TRANSITION (MAR-APRIL)

COMMUNIST CHINA

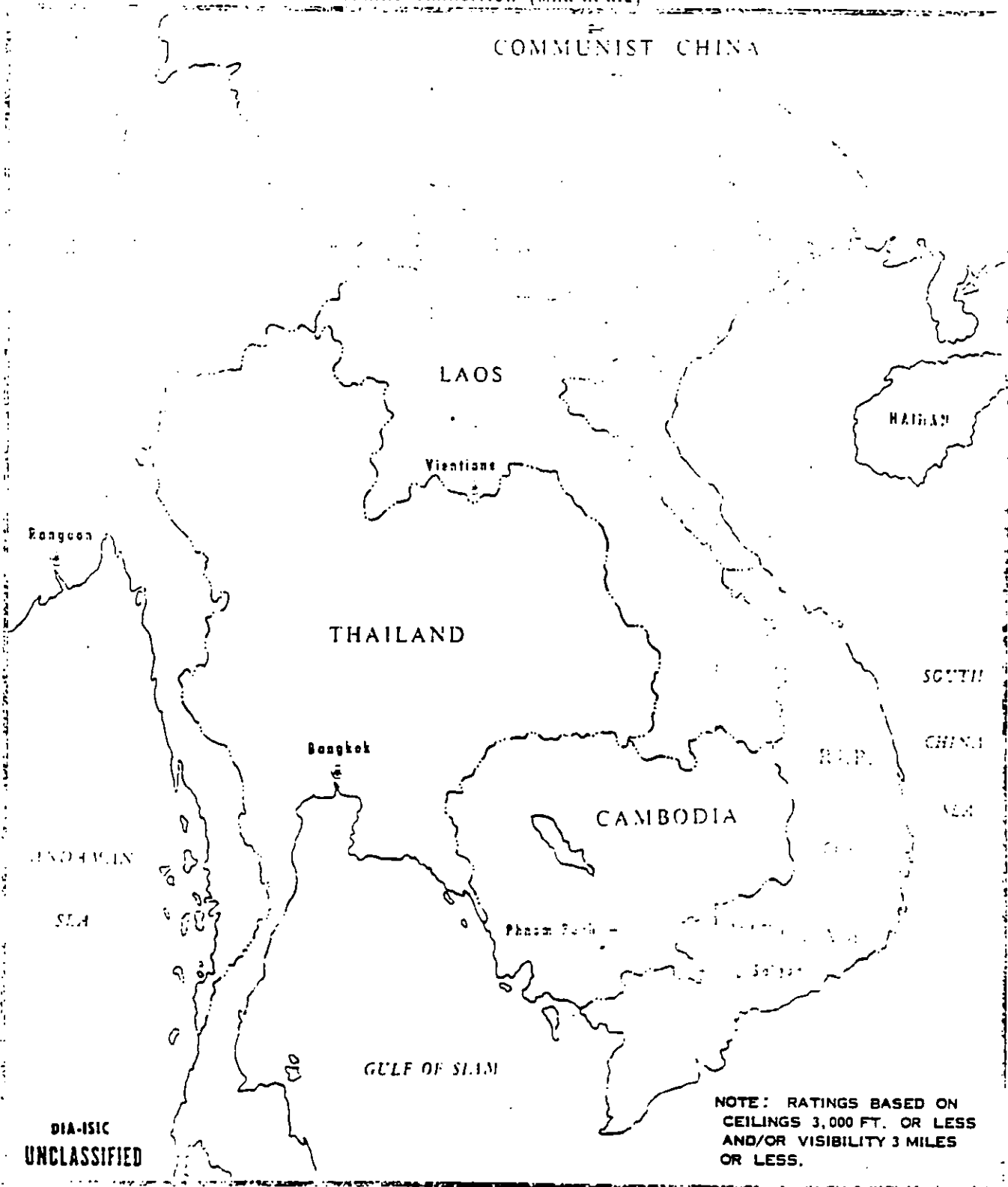

NOTE: RATINGS BASED ON CEILINGS 3,000 FT. OR LESS AND/OR VISIBILITY 3 MILES OR LESS.

- POOR - OPERATIONS RESTRICTED MORE THAN 60% OF THE SEASON.
- FAIR - OPERATIONS RESTRICTED BETWEEN 30% AND 60% OF THE SEASON.

- GOOD - OPERATIONS RESTRICTED LESS THAN 30% OF THE SEASON.

DKC-1

Tab C to Annex K to Appendix D

(AIR OPERATIONS-AUTUMN TRANSITION (OCT)

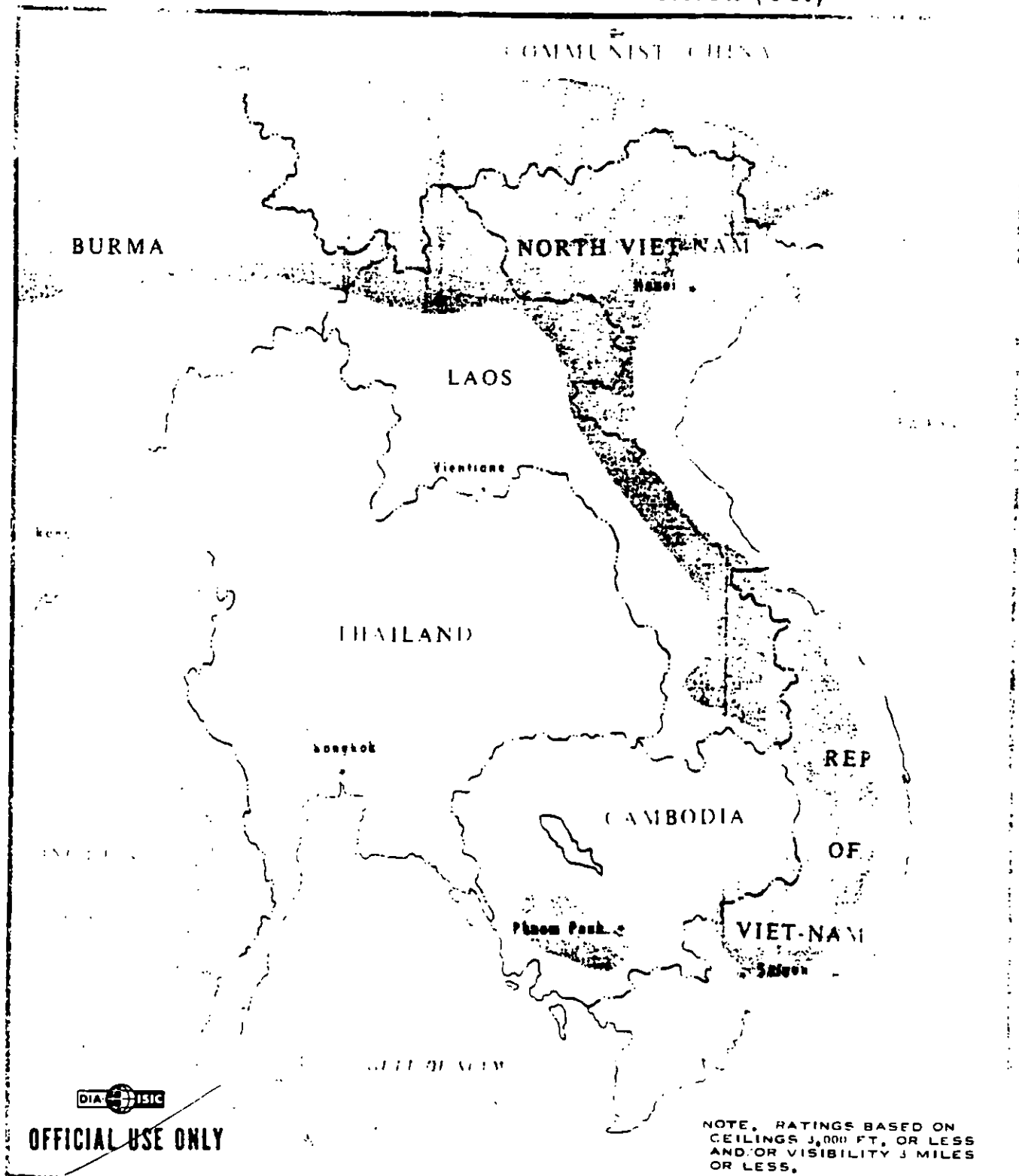

- POOR-OPERATIONS RESTRICTED MORE THAN 60% OF THE SEASON.
- FAIR-OPERATIONS RESTRICTED BETWEEN 30% AND 60% OF THE SEASON.

- GOOD-OPERATIONS RESTRICTED LESS THAN 30% OF THE TIME.

DKD-1

Tab D to Annex K to Appendix D

GROUND TRAFFICABILITY—SOUTHWEST MONSOON (MAY-SEP)

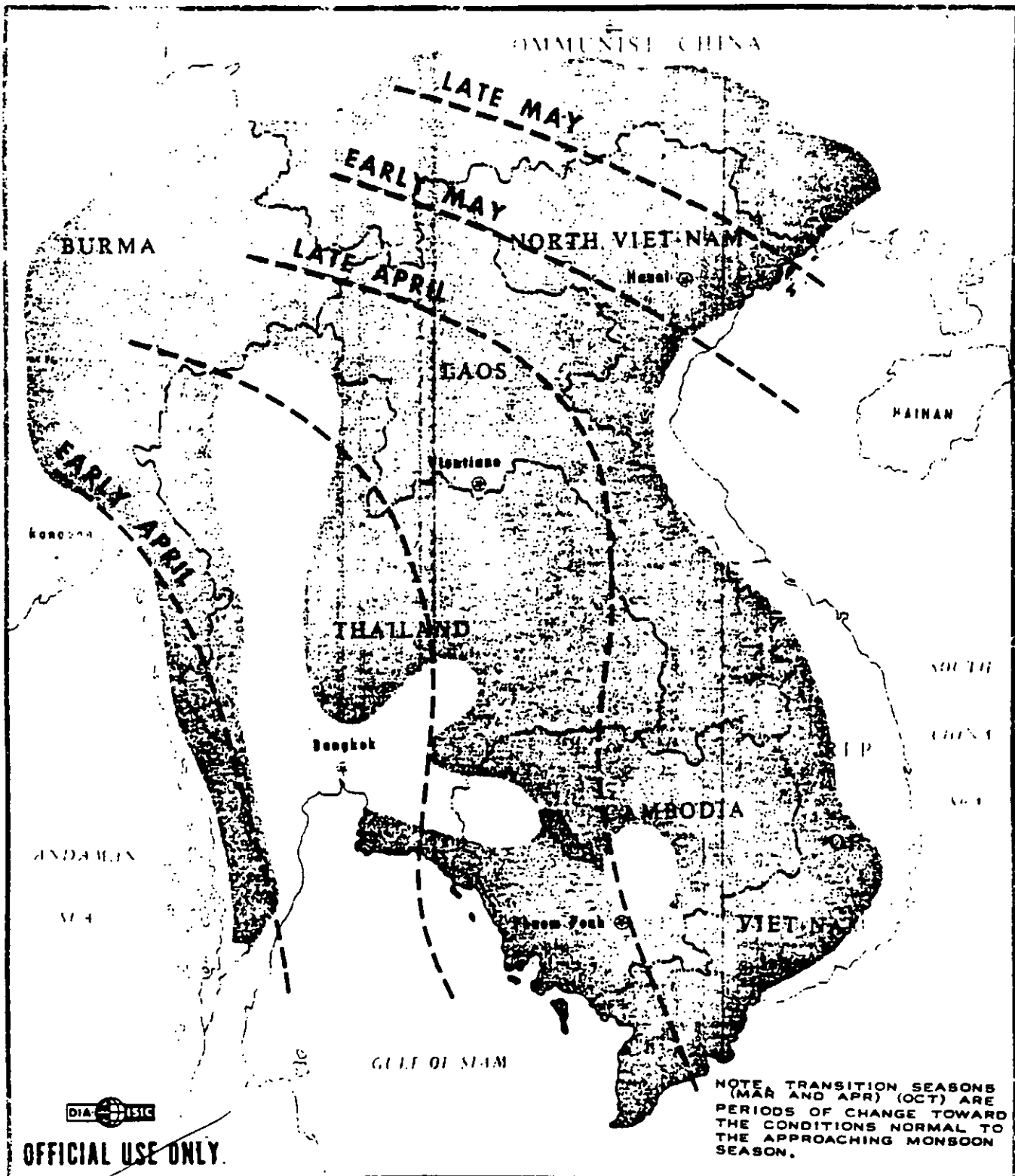

DKE-1

Tab E to
Annex K to
Appendix D

TAB F TO ANNEX K TO APPENDIX D
GROUND TRAFFICABILITY—NORTHEAST MONSOON (NOV-FEB)

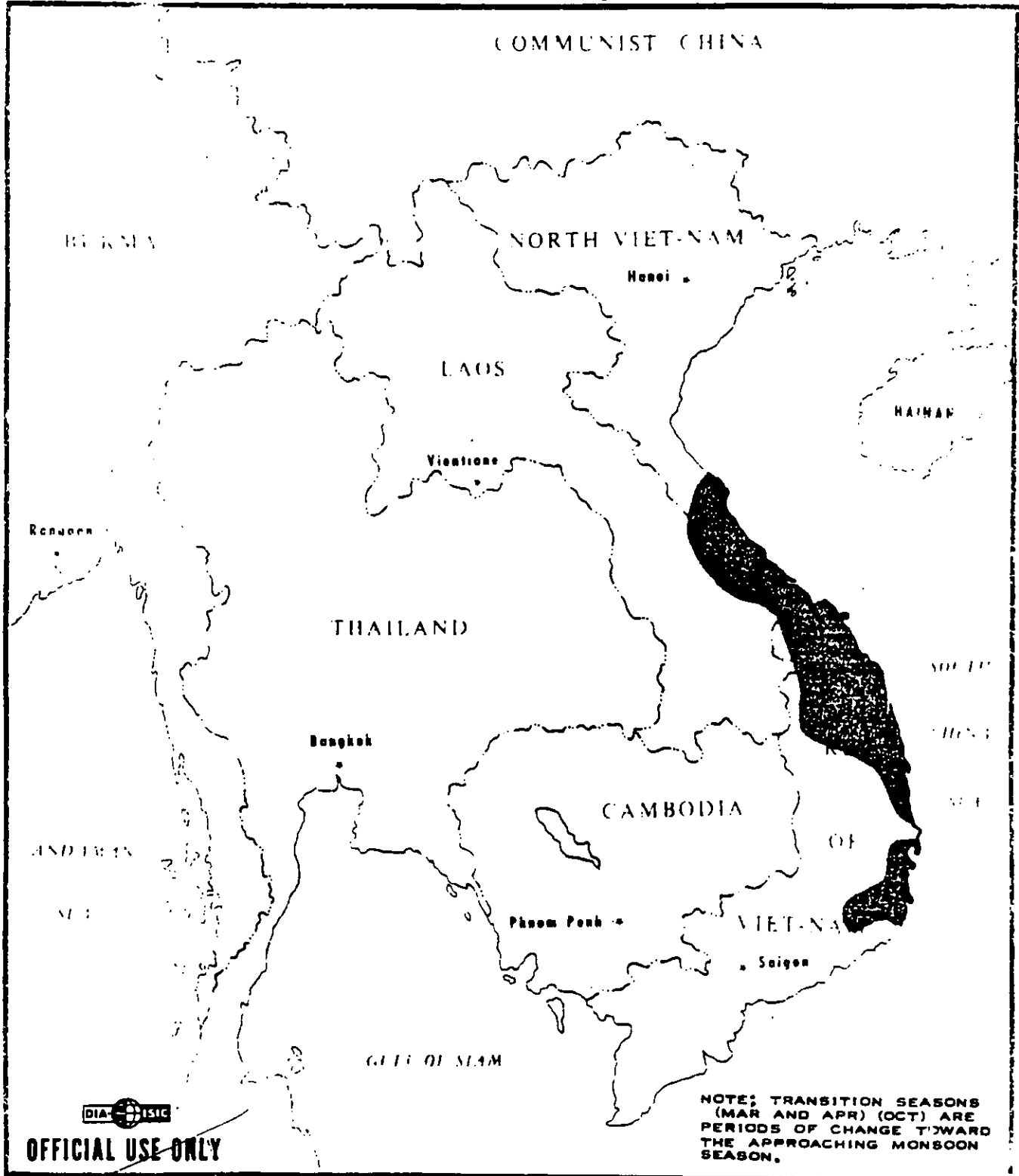

OFFICIAL USE ONLY

NOTE: TRANSITION SEASONS (MAR AND APR) (OCT) ARE PERIODS OF CHANGE TOWARD THE APPROACHING MONSOON SEASON.

- POOR—DIFFICULT TO OPERATE FOR MORE THAN 50% OF THE SEASON.
- FAIR—OPERATIONS POSSIBLE FOR MORE THAN 50% OF THE SEASON.

- GOOD—OPERATIONS POSSIBLE FOR MOST OF THE SEASON.

DKF-1

Tab F to
 Annex K to
 Appendix D

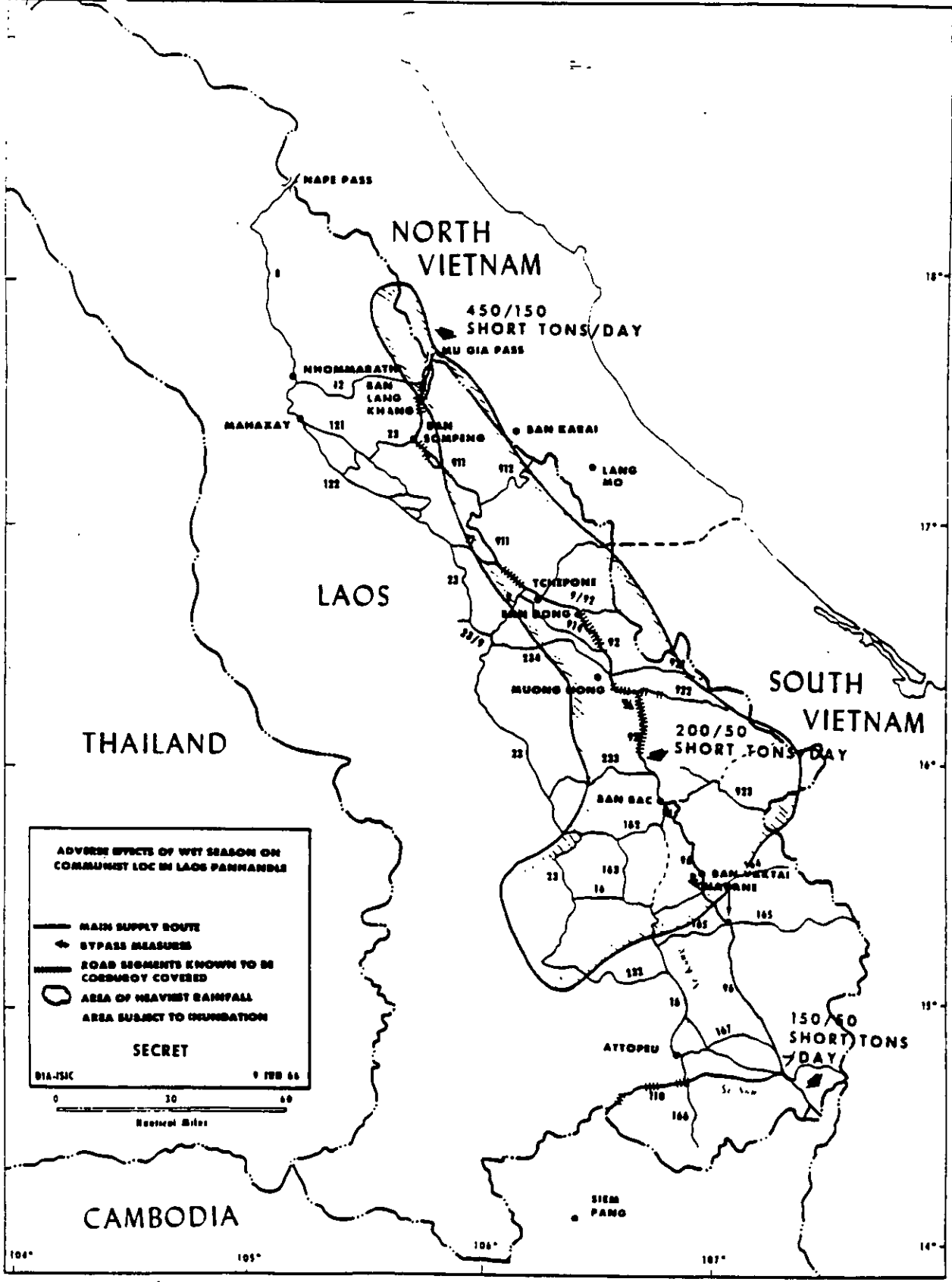

ANNEX L TO APPENDIX D

LOGISTICS AND SUPPORT

1. (S) Petroleum Oil and Lubricants

a. All Petroleum Oil and Lubricants (POL) in North Vietnam must be imported. Nearly all of the POL arriving in North Vietnam comes by sea through Haiphong. The unloading time is about 20 days for large tankers and five days for small tankers. US air strikes destroyed 61 percent of the total NVN POL storage capacity. Since the extensive US strikes on POL facilities, North Vietnam has shifted to a costly and increasingly extensive system of dispersed storage, but has been able to meet its requirements without significantly curtailing military operations.

b. Once POL is in the country, the flow continues by way of rail, water, and trucks to transport, distribution is made to selected refueling points and storage areas.

c. Because of the restrictions to US air strikes in and around the Hanoi and Haiphong area, the North Vietnamese are able to import, disperse and distribute vitally needed POL.

2. (S) Electric Power

a. Development of electric power in North Vietnam has had high priority in support of the limited industrial economy and a prerequisite for industrial expansion. Establishment of electric power capacity has been concentrated in the Hanoi-Haiphong region. This effort has been contingent on aid from communist countries, particularly Communist China and the Soviet Union.

b. The electric power industry is government owned and in May 1966 had an estimated installed capacity of 140,000 kw.

c. Although the country's waterpower potential is estimated at 13,600,000 kw, development of the

country's electric power was initially directed toward building coal-burning thermal power plants which account for 97 percent of the entire capacity. The remaining three percent is supplied by hydroelectric generation with irrigation projects utilizing one percent of this.

d. The only significant transmission network is centered on Hanoi and integrates eight major thermal power plants which account for about three-quarters of the total national capacity. The network is small, mainly composed of single line connections radiating from the capital area and controlled by a single major transformer and switching station (Dong Anh) about 10 Km north of the city. This converging of the few important transmission lines seriously restricts the possibility of alternate sources of supply in the event of equipment failure. The limited extent of the network and its design has required erection of only a small number of sub-stations. Transmission connections are by overhead lines, carried largely by prestressed concrete supports and steel towers.

e. The industrial sector of the economy is the principal user of electrical power (estimated 90 percent of the total) and the bulk of industrial use is in the Hanoi-Haiphong area.

f. Most major electrical development projects will probably be delayed due to the possibility of damage by air strikes. The highest priority is rehabilitation of the damaged Uong Bi power plant which was the main baseload installation in the Hanoi-Haiphong complex. If necessary repairs are undertaken it would be possible to resume operation there within three months.

g. The main electric power project under construction in North Vietnam is the Lang Chi hydroelectric power plant at Thac Ba. Its planned capacity of 112,500 kw is three-quarters of the May 1966 total for the entire country. This plant is being built with Soviet aid. No construction actually has been noted there in the past six months.

~~SECRET~~

h. The NVN electrical power capacity could double in FY 68 through new construction alone and with repairs of damaged facilities could go as high as 383,000 KW. It is estimated that by FY 70 electric power capacity could reach 800,000 kw if the hydroelectric power plant on the Black River at Hoa Binh is constructed.

3. (S) Military Equipment Delivery

a. Major military equipment for North Vietnam has been delivered via the Chinese rail system. Aircraft, SAM equipment, and other bulky military items are believed to have been delivered overland. Most of the military equipment in North Vietnam has been delivered in this fashion by the Soviet Union with China responsible for lesser quantities. Eastern Europe has played a negligible role. Both Moscow and Peking have openly stated that military material is transported by the overland route through China.

b. Available information on shipping to North Vietnam shows no firm evidence that weapons systems have been delivered by sea. Observers in NVN ports have not reported evidence of the security precautions that such shipments would probably entail. The size of cargoes carried by ships in this trade indicates that they are non-military because in general the bulky nature of military cargoes except for ammunition and small arms results in lightly laden ships. The only lightly loaded ships coming into North Vietnam thus far have been identified as vehicle carriers.

c. Although there has been congestion and delay from time to time at Haiphong, that port could handle a substantial volume of military shipments without reducing commercial imports. The congestion results in warehouse and dock congestion due to a shortage of trucks to move the material from the port area.

d. As Sino-Soviet relations deteriorate there has been an increase in the volume of reports that Soviet rail shipments to North Vietnam via China have been prohibited. If the Soviet role were

~~SECRET~~

DL-3

Annex L to
Appendix D

limited to sustaining the military effort in North Vietnam by a flow of ammunition and spares, sea-borne delivery could be accomplished with a minimum of disruption to present sea shipments. The problem might be complicated if the Soviet Union should desire to add new weapons systems or supply additional quantities of weapons. The delivery of these bulky systems would result in added congestion in the Haiphong port.

e. Current estimates indicate that rail imports to North Vietnam of weapons combat equipment and ammunition during 1966 amounted to 240,000 MT. Of this total the Soviet Union is estimated to have provided 185,000 MT with the remainder furnished by China. This equates to an average of about 20 freight cars per day with one or two cars devoted to SA-2 missiles based on four SA-2s per car and a monthly expenditure rate of 150-160 missiles.

f. It is estimated that at least 42,000 MT of the dry cargo shipped from Soviet and East European sources was unidentified. Some of this cargo might have been military despite the fact that, to date, concrete evidence to support this conclusion is lacking.

4. (S) Projected Military Support

a. The Soviet commitment in North Vietnam has been conditioned largely by the conflict between Moscow and Peking and this promises to be the chief political consideration in the immediate future. The Soviet Union has thus far refused to respond to Chinese provocation and break diplomatic relations. This is believed due to the problems that might arise concerning the rail transit of Soviet military supplies through China to North Vietnam. One such problem could well be the risk of a possible Soviet-United States confrontation on the high seas. It should be noted that a complete break in Sino-Soviet state relations would not necessarily bring an end to the delivery of Russian military supplies by rail through China although it would make the possibility more likely. Based on the current estimated trends in ammunition expenditure rate, it is expected that

ammunition expenditure will increase through FY 68 with associated logistic considerations.

b. Continued air strikes on the roads, bridges, and rail lines of North Vietnam will serve to increase the distribution problem for the North Vietnamese and contribute or add to port congestion.

c. If the northeast rail line was interdicted to the point of significantly reducing rail imports, there would probably be a 30 to 60 day lag between interdiction and arrival of military goods in North Vietnam by sea. The delay is based on shipping time and the time required to divert goods already processed for rail shipment.

5. (S) AAA Gun Logistics Data

a. Data contained in Table 1 represents data extracted from collateral sources pertaining to Soviet and Warsaw Pact air defense units. It is believed that this information is current and is pertinent to air defense units in North Vietnam as well.

b. Weapon tubes may be used after the theoretical tube life has been reached; however, such use will result in reduced accuracy and effectiveness. Excessive tube wear causes projectiles to tumble thereby reducing range as well as accuracy in azimuth.

c. The term "day of fire" represents the number of rounds planned to be fired PER TUBE PER DAY. This figure logically changes from day to day depending upon the number of raids. The figure indicated in Table 1 is based on an average taken over a year's time.

~~CONFIDENTIAL~~

TABLE 1
AAA Gun Logistics Data

BARREL

<u>Weapon</u>	<u>Barrel Wt lb</u>	<u>Tube Life Nr Rds</u>	<u>Nr Barrels Per Pack</u>	<u>Barrel Pack Wt</u>
12.7	27.77	5,000	4	150 lb
14.5	31.6	5,000	4	175 lb
37-mm	262	10,000	1	332 lb
57-mm	728	600-1000	1	810 lb
85-mm	452 _a /	2,800	1	1000 lb
100-mm	3,307	2,800	1	4000 lb

AMMO

	<u>Basic Load</u>	<u>Day of Fire</u>	<u>Nr Rd Packed per Box</u>	<u>Wt - lb</u>
12.7	3,000	20	170	65
14.5	3,000	20	80	66
37-mm	160	8	30	147
57-mm	120	6	5	108
85-mm	140	6	4	183
100-mm	140	6	2	180

a/ Uses replaceable barrel liner

~~CONFIDENTIAL~~

DL-5a

Table 1 to
Annex L to
Appendix D

~~SECRET~~

ANNEX M TO APPENDIX B.

EFFECTS OF REDUCTIONS TO IMPORTATION
AND RESUPPLY ON NVN AIR DEFENSE

1. (S) The NVN Air Defense System is totally dependent upon external logistic support. A critical situation would therefore develop if this aid were curtailed or substantially reduced.

2. (S) The possibility of estimating with accuracy the exact effect of such an action is difficult due to the following unknown or uncertain factors:

a. Quantities of specific material imported routinely are not known with accuracy.

b. Existing stockpiles of missiles, AAA ammunition and spare parts for equipment are unknown.

c. AAA expenditure rates are uncertain. Best estimates presently indicate an average expenditure rate of 18,000 metric tons per month.

3. (S) A sustained reduction of 60 or 80 percent in external logistic support to North Vietnam would probably effect the air defense system equally as follows:

a. Utilization and effectiveness of EW/GCI and fire control radar equipment (including FAN SONG) would decrease as availability of spare parts decreased. Early warning systems would probably show little short time effect of the reduction due to duplications of equipment coverage and probable information, at least on targets above 10,000 feet, passed to Hanoi by CHICOM radar coverage. Fire control radars would decrease in coverage as essential components fail. Over-all, radar equipment, being non-consumable, would reflect the least change due to importation restrictions.

b. Reduction in POL imports would impact heavily upon the jet fighter force and would probably result in a curtailment of training activities as a fuel

~~SECRET~~

DM-1

Annex M to
Appendix B

conservation measure which in turn would degrade the air intercept capability.

c. The SA-2 firing rate would decline as the in-country stockpile reduced. Current stock level and rate of importation is unknown. Over the past six months missile firings have averaged 153 per month. A rough estimate based in part on Soviet doctrine would indicate an in-country resource of 1260 missiles. At the current level of air activity and present monthly firing averages it would appear that about nine months supply of SA-2s may be in North Vietnam. If current imports maintain whatever stockpile is in being, about 150 missiles must be delivered on a monthly average. A 60 percent reduction in pure mathematical terms would allow 60 missiles per month to enter North Vietnam, extending the stockpile, under current firing rates, slightly less than one-third of an average firing month each month. An 80 percent reduction would in the pure sense allow 30 SA-2s or one-fifth of an average month's firings. If current estimates of SA-2 in-country resources are correct, an over-all capability exists to sustain current firing rates for 10 months with an 80 percent reduction and 12 months with a 60 percent reduction in importation. Of course, whatever statistical analysis made will be invalid as conservation and selectivity in firing begin to appear in SAM tactics.

d. AAA fire would quite likely revert to a more disciplined radar controlled type of fire rather than the barrage type now commonly encountered. The intensity of AAA/AW fire would probably decrease with the stock level as conservation measures are applied. The present stock level of AAA ammunition is unknown. The total Soviet basic load for all AAA weapons in North Vietnam is estimated at 9390 MT. This Soviet doctrine plans for approximately 20 days of firing in a combat condition. Current estimates, based on incomplete firing data, would equate to the annual import of 220,000 MT or 18,300 MT per month to sustain this firing rate. A reduction of 60 percent in AAA ammunition imports would reduce monthly average imports to less than one Soviet basic load and a reduction of 80 percent to about one-third of a Soviet basic load.

e. SAM and AAA defenses would begin to concentrate in key areas of lines of communications and militarily significant complexes.

4. (S) Storage capacities, stock level and consumption rates for jet fuel and aviation gas are estimated below. Monthly imports are not presently identifiable:

Jet Fuel

Storage capacity	11,235 MTs
85% on-hand inventory	9,550 MTs
Monthly requirement	1,300 MTs

AV/Gas

Storage capacity	820 MTs
85% on-hand inventory	697 MTs
Monthly requirement	86 MTs

Estimated on-hand inventories versus monthly requirements indicate that without resupply current air activity could be maintained for approximately seven months. This period could be reduced if on-base POL storage facilities were destroyed.

5. (S) A concerted effort is presently being directed to the problem of filling the existing intelligence gap relative to importation and levels of storage of military hardware and consumables.

ANNEX N TO APPENDIX D,

SYSTEM DEFICIENCIES AND VULNERABILITIES

1. (S) The NVN Air Defense System, while functioning at a significant level of effectiveness considering its rapid growth, has certain facets which appear vulnerable to disruption.

a. A major vulnerability is the logistic system. All components of the complex are or have been imported. North Vietnam has little or no capability to produce original or replacement parts except for foundry or machine tool products. Damage and destruction to all parts of the system must be countered by importation or use of in-country reserves. The rail and port facilities in North Vietnam process all but the air delivered material and therefore render the air defense system vulnerable, at least over the long term, to a stoppage of material support.

b. In air defense communications, the probable use of radio to keep Hanoi informed of the air situation is vulnerable to countermeasure of sufficient intensity and application.

c. During heavy US air operations, the ability of North Vietnam to command and control all components in an efficient manner for maximum effect is questionable.

d. The vital components of the air defense system probably revolve around Air Defense Headquarters which is believed to be at Bac Mai airfield. Component commanders or duty commanders may operate from this location. In order to receive warning of US air activity, they require timely and accurate inputs from radar stations probably through intermediate command or filter centers. These centers perform a key function, in that radar duplication would allow the center to function even with casualties in subordinate radar equipment.

2. (S) In the SA-2 system there is a critical requirement to assemble and test missiles. This is performed with sophisticated testing equipment in mobile vans or stationary facilities. Periodic testing is required for ready missiles. The loss of this testing capability could seriously affect the missile defenses. Only three such facilities have been identified and confirmed to date and others are believed to exist.

3. (S) POL remains a prime requirement for aircraft as well as motor operated support such as diesel power generation and mobile support equipment.

~~SECRET~~

ANNEX C TO APPENDIX B

PROBABLE WORLD REACTIONS TO EXPANSION OF US
AIR ACTIONS IN NORTH VIETNAM

1. (S) Presently the US military actions against North Vietnam are limited by certain constraints. In general these constraints prohibit ordnance delivery in the cities of Hanoi and Haiphong, the CHICOM/NVN border areas and primary airfields as well as the mining of Haiphong harbor. Should the United States decide to increase the level of offensive activity by gradual, selective, or complete lifting of these constraints, considerable attention would be focused on world reactions and potential counteractions. Particular areas of concern would be the reactions of North Vietnam, China and the Soviet Union, and major Free World countries. The timing of possible actions and the rate at which they might be applied has not been addressed as it is an unknown factor.

2. (S) Free World. Many of the actions taken by the United States in a limited expansion of its air actions, though moderate, would be recognized by news media as beyond present self-imposed restrictions, and thus chargeable as "escalation" or "widening of the war" by those who choose to do so. Denunciations of the United States, independent action in the United Nations, and other political protest activities might be forthcoming as a result of a change in US actions in Vietnam. The amount and tone of Free World criticism and denunciations would be in direct proportion to the degree of expansion of the US effort. It is unlikely, however, that any Free World country will modify adversely its bilateral relations with the United States or change its policy to the point of offering significantly greater political or material support to the Vietnamese communists.

3. (S) Communist World

a. North Vietnam. Intensified US actions under a program of limited expansion, would probably not, in and of themselves, cause any basic change in NVN policy. They probably would wait to judge the effects

~~SECRET~~

DO-1

Annex C to
Appendix B

of limited action before considering any basic change in their policy toward the war. Hanoi's propaganda machine could be expected to mount an outcry at each indication of increased escalation. North Vietnam would be very likely to endure gradually increased US pressures for a while hoping that international and domestic influences would induce the United States to relent. However, if the United States maintained these increased pressures and no relief appeared in sight, the NVN leadership might consider that a basic policy review was required and that some form of negotiations might be in their best interests. Being aware of the fact that the expressed US policy is not to destroy the NVN government, they might hope to achieve immediate relief from the military pressures as well as reach an acceptable longer range solution through negotiation. However, prior to reaching this position, North Vietnam might de-escalate in hopes that the United States would do the same. Another NVN action in the opposite direction and prior to reaching any situation that would force negotiation, might well be to invite still greater Soviet and CHICOM participation in order to avoid being put into a position of being forced to negotiate.

b. Communist China

(1) Peking would react noisily to limited increases in the scope of US attacks, but it is unlikely that the Chinese response would go beyond propaganda blasts and possible attempts to increase logistic support for Hanoi. Air defenses in South China would continue to be strengthened. Additional Chinese air defense troops, if needed and requested, would be deployed to North Vietnam. It is not likely, however, that Peking or Hanoi would consider the situation critical enough to call for overt intervention of Chinese combat forces. The Chinese, however, almost certainly would attempt to increase the level of logistic support in an effort to compensate for restrictions imposed on seaborne supply by the closure of Haiphong.

(2) Under conditions of moderate US escalation, it is not believed that the Chinese would commit

their air force in defense of North Vietnam or introduce substantial numbers of Chinese ground combat troops into North Vietnam. United States actions could aggravate tension over policy issues in the current internal political struggle but would be unlikely to prove decisive in tipping the balance to one faction or another. Closure of NVN ports would tend to give China almost complete control over aid to North Vietnam and further increase CHICOM leverage over Hanoi at the expense of the influence of the rest of the communist world.

(3) If all current constraints upon US actions in North Vietnam were lifted, China would probably build up its combat forces in the South China area opposite North Vietnam and Laos. Such a build-up would include infantry, aircraft, PT boats and probably some submarines. Some units could be placed in North Vietnam against the possibility of a US invasion of North Vietnam. The possibility also exists that NVN aircraft could operate from South China airfields but communist experience shows a greater preference for AAA and SAMs in the air defense role.

(4) Finally, the possibility must be considered that Red China could use increased US involvement in an attempt to divert some of the attention of the Chinese people from internal difficulties by a more open involvement in North Vietnam. In addition, the possibility exists that China might create some diversionary actions opposite Taiwan or in Northern Thailand and Laos, which would generally fall far short of open hostilities in those areas.

c. Soviet

(1) Under conditions of limited US expansion, Moscow, of course, would denounce the United States for intensifying its "policy of aggression" in Southeast Asia. The Soviets would seek to marshal world opinion against any blocking of Haiphong port by attempting to show that US actions were

a violation of the freedom of the seas. They would probably attempt to increase their land and air shipments to North Vietnam and would continue to make sea shipments to the extent possible through Cam Pha and Hon Gai and by transshipment through Chinese communist ports. Moscow would increase its propaganda against the US bombing activity in direct proportion to the degree that the bombing included additional civilian targets. They would renew pledges of support to Hanoi, and might respond in some demonstrative way to requests for more aid in air defense. This might not include a more overt involvement of Soviet personnel in military and technical advisory and support roles in North Vietnam.

(2) In the event of a moderate escalation of US efforts, the Soviets would urgently seek to ascertain the NVN attitude toward a political settlement and toward Chinese intervention. The Soviets are committed to aid North Vietnam and to help defend it against air attacks, but they would recognize their continued inability to do so effectively. However, they would probably have little choice politically but to try to meet Vietnamese requests for assistance, though they would continue to avoid overt involvement in the conflict and seek to prevent a direct military confrontation with the United States.

(3) Soviet reaction to a complete lifting of constraints of United States actions would be mainly propaganda. Their two major themes would be accusations that the United States was expanding the war into Laos and was escalating the conflict by bombing the airfields. This last tactic would create personal bitterness because of the Soviet commitment to build a viable air defense system in North Vietnam. However, because their sea-borne aid would have been cut off due to the closure of the ports or require transshipment through China, with the latter's cooperation, the Soviets might privately advise the North Vietnamese to de-escalate the conflict.

~~SECRET~~

(-) If the efforts against the NVN ports were successful in stopping aid by sea, the North Vietnamese would probably call upon the CHICOM to allow Soviet aid to be transhipped by rail through China in the interest of supporting a "common cause." The Soviets would be forced to rely completely on Chinese cooperation for further transshipment except for a very limited amount of aid which could be airlifted by alternate air routes. In this instance the Soviets would face a choice between terminating their aid (and perhaps their influence in Hanoi) and making political concessions to the Chinese to gain their cooperation for transit through China. In either instance the Soviet position would be degraded. Actual Soviet involvement would probably be confined to assisting NVN forces with additional Soviet military and technical volunteer advisors. Many areas of United States-Soviet cooperation would be seriously affected and probably result in an across-the-board deterioration of relations between the two nations.

~~SECRET~~

DO-5

Annex O to
Appendix D

~~SECRET~~

ANNEX F TO APPENDIX D--

INTELLIGENCE GAPS AND UNCERTAINTIES

1. (S) The following areas of the NIGHT SONG air defense analysis in North Vietnam involve intelligence gaps or areas of uncertainty where data is incomplete or non-existent.

a. All radar sites are not positively identified and/or located in aerial photography.

b. Filter centers are not positively identified and/or located in aerial photography.

c. An accurate identification or assessment of the material being imported as well as the means of importation is not possible at this time.

d. An accurate identification or assessment of in-country reserves of military material is not possible at this time.

e. The precise location of all SAM support, assembly, test, and check-out facilities is not known.

2. (S) There appears to be a lack of coordinated effort to collate SIGINT and operational intelligence in order to provide in-depth operational and intelligence analysis on the performance and effectiveness of both US and NVN tactics. This analysis probably has the most immediate application at the tactical level.

~~SECRET~~

DP-1

Annex F to
Appendix D

ANNEX Q TO APPENDIX E -

CONCLUSIONS

1. (S) An analysis of the quantity, quality, operation, and effectiveness of the NVN Air Defense System provides the following conclusions:

a. The system provides complete surveillance and early warning coverage for North Vietnam and bordering areas.

b. Radar and AAA presently shows considerable density allowing for absorption of heavy losses and damage without immediate degradation of effectiveness.

c. SAM defenses are expanding. Widespread construction of prepared launching sites allows for frequent, short range, relocations to hinder detection and attack with minimal loss of effectiveness.

d. Jet aircraft are dispersing and airfield construction and improvement presently underway will provide an even greater dispersal.

e. Command and control is adequate and improving.

f. The amount of radar equipment provides a significant ECCM capability through the resulting multi-frequency spectrum available.

g. All components contribute to US losses with the heaviest toll being taken by AAA and ground fire.

h. North Vietnam is almost totally dependent on imports to develop, operate and maintain their air defense system.

i. North Vietnam has a weak technical base for indigenous operation and maintenance of most weapons systems. Foreign assistance is required for the near future.

j. Precise intelligence on the amount and means of importation of military hardware to North Vietnam is incomplete. That information which is available, however, tends to indicate that the majority of military hardware arrives in North Vietnam by rail.

k. Intelligence is available on a large number of air defense components such as radar sites, communications facilities, and SAM sites, airfields POL and military storage areas, lines of communication, logistic facilities and power sources. Much of this target base has already been targeted and an additional large portion is known in sufficient detail to permit photographic search for at least target identification.

l. Destruction or neutralization of vital elements of the NVN air defense system would have a degrading effect on the over all system performance.

m. Intelligence is available to support real-time tactical operations. The means of dissemination are in the development stage with some current applications existing.

n. Future improvements will be in the quality of surveillance radar and quantity of AAA, fire control radar, SAM battalions and MIG aircraft.

o. The NVN Air Defense System, as a system, will be difficult to eliminate or starve unless maximum sustained efforts are applied.

p. Regardless of US pressure, Soviet and CHICOM technical and advisory assistance will continue and probably increase.

q. A significant loss in intelligence may result if NVN Command and Control and Electronic Systems are destroyed.

ANNEX R TO APPENDIX D

BIBLIOGRAPHY

1. Memo for CJCS 26 January 1967 SI-S-106/AP-4. Manning of North Vietnamese Air Defenses.
2. CINCPAC ltr 001235 30 July 1966 (S). SA-2 Effectiveness.
3. SI-S-104/AP-4. The North Vietnam Air Defense System.
4. DIAAP-4 Fact Sheets, North Vietnam.
5. DIAAP-3A North Vietnam Radar Expansion.
6. DIA Radar CEPs by type.
7. Factors Affecting Air Ops...J-3 Study Group (TS).
8. DIAAP-1-435-2-4-66 INT POL Consumption in North Vietnam (S).
9. JSTPS DASMC 66-44543 Air Defenses, Soviet and Asian Communist Blocs, JCS S1OP (S).
10. NPIC/R-267/66 Southeast Asia Activity Report. Communications Facilities North Vietnam (C).
11. DIAAP 3A7 PAF 210-0175/003 North Vietnam EOB (S).
12. 7AF-D10-66-01098 Air Defense System, North Vietnam (S).
13. JCS Southeast Asia Air Operations Study Group Report on Factors Affecting Combat Air Operations and Aircraft Losses in Southeast Asia (TS) November 1966.

~~SECRET~~

APPENDIX E

WEAPON SYSTEMS AND MUNITIONS

1. (S) This appendix identifies selected weapons systems, munitions, and equipments which are available or will be available in the future for use by United States Forces against all elements of the NVN Air Defense System. The purpose of this appendix is to provide sufficient detail on the characteristics, capabilities, and availability of these equipments to allow for preliminary recommendations for their future tactical employment and to identify potential equipment shortages and deficiencies.

2. (S) The air defense threat is composed of airborne intercept aircraft, antiaircraft artillery (AAA), small arms and automatic weapons, and surface-to-air missiles (SAM). Essential to effective use of these hardware systems are the communications, radars, electronics, personnel, and supplies necessary for their employment. The hardware considered in this appendix is, therefore, any equipment capable of detecting, degrading, nullifying, or destroying any of the elements of the NVN Air Defense System. These include airborne platforms and systems, air-to-air and air-to-ground munitions, sensors, cameras, and passive and active electronic warfare equipment.

~~SECRET~~

ANNEX A TO APPENDIX E

AIRCRAFT

1. (S) General

a. The current inventory of aircraft available for use against North Vietnam include the following by general categories:

FIGHTER ATTACK

NAVY

A-1 H/J
A-4B/C/E
A-6A
F-4B
F-8

AIR FORCE

F-4C
F-105D

RECONNAISSANCE

NAVY

RA-3B
RF-4B
RF-8A/G
RA-5C

AIR FORCE

RF-101
RF-4C

ELECTRONIC WARFARE

BOMBER

AIR FORCE

B-52

NAVY

EA-1F
EA-3B
EA-6A
EF-10B

AIR FORCE

EB-66B/C
EC-47
C-130A/B
RC-135

EARLY WARNING AND CONTROL

NAVY

E-1B
E-2A
EC-121M

AIR FORCE

RC-121D

TANKERS

NAVY

EKA-3B
KA-3B
KC-130

AIR FORCE

KC-135A

b. Other aircraft in use in Southeast Asia such as the A-1E, F-5, F-100 and F-104, are not included in this discussion. The F-5 and the F-104 are not included in this section since they will not be in the US inventory in Southeast Asia after FY 67. The other aircraft are particularly adapted to and are urgently required for close air support and in-country operations. They offer no advantages not present in

~~SECRET~~

the aircraft listed for use by US Forces against North Vietnam.

c. Unfortunately, the present inventory aircraft have proven quite vulnerable to small arms, automatic weapons, and light antiaircraft artillery. This is due primarily to aircraft design criteria which has stressed aerodynamic and weapon system performance, reliability, and maintainability rather than combat survivability. There is little evidence to indicate that this is not also true for the next generation of aircraft such as the F-4D/E/J, A-7A/D, and the F-111A/B.

2. (S) Aircraft Attrition

a. A primary motivation for the NIGHT SONG Study is the potential for increased losses of aircraft and pilots in future operations against North Vietnam, due to probable qualitative and quantitative improvements in the NVN Air Defense System.

b. Analyses of aircraft losses in operations against North Vietnam provide the following interesting conclusions:*

(1) In spite of an effective and ever expanding NVN Air Defense System, there has been a significant downward trend in aircraft loss rates on strike missions in North Vietnam.

(2) The loss rate due to hit-caused control failure has been significantly lower for the A-4 aircraft which has a mechanical back-up flight control system.

* See Op-05W/OEG, December 1966, Analysis of US Navy, Marine Corps, and Air Force Fixed Wing Aircraft Damage and Losses in Southeast Asia (SECRET).

~~SECRET~~

EA-2

Annex A to
Appendix E

(3) The pilot recovery ratio has remained relatively constant at 35 percent for aircraft lost over North Vietnam.

(4) No statistically significant difference is apparent in the loss rate of single versus twin-engine aircraft.

(5) The F-8 has a loss rate significantly higher than that of any other aircraft type on similar missions. The reasons are not known, but vulnerability of the control system is suspected.

(6) For all aircraft, the average damage to loss ratio is 5.1 to 1.

(7) Over 70 percent of aircraft combat losses have been due to automatic weapons and light AAA.

(8) Aircrew recovery is a function of the time the aircraft remains controllable after being hit. The aircrew was recovered in 93 percent of the cases where the aircraft was controllable for five or more minutes.

(9) Ninety percent of aircraft losses were due to hits below 7,000'. Twenty-eight percent were below 1000'.

(10) Seventy-six percent of Air Force and 70 percent of Navy losses were during the attack phase with 25 percent AF and 23 percent Navy losses against bridge targets.

(11) Fire associated losses accounted for 75 percent of Air Force losses and 50 percent of Navy.

3. (S) Aircraft Improvements

a. In FY 68, the A-7A and F-4J will be available to the Navy and the F-4D to the Air Force. The A-7A will offer an increased flexibility for interdiction because of its large number of external stores stations and greater fuel capacity. The F-4J is a higher

~~SECRET~~

performance follow-on to the F-4B and incorporates a look-down capability in its radar systems. The Air Force F-4D will have an improved air-to-ground weapons delivery capability due to its weapon release computer, lead computing stabilized optical sight, and air-to-ground radar ranging.

b. After FY 68, the F-111A, A-7D, and F-4E will begin entering the Air Force inventory. The F-111A will have extended range and will provide for all-weather operations in support of interdiction efforts and air-to-air combat. It will be capable of the full spectrum of non-nuclear missions. The A-7D is a light attack fighter with an extended radius of action or long loiter time over the target area. Eight external stores stations will allow it to carry wide variety of conventional ordnance in loads up to 15,000 pounds for air-to-surface visual weather delivery. The F-4E will have an improved air-to-air capability with the addition of an internal 20mm cannon, the APQ-120 Fire Control System, an optical sight, and improved J-79 engines.

c. The introduction of E-2B will provide an improved carrier-based early warning and control aircraft, with extensive electronics and communications equipment. The EA-6B will be available in FY 70 with primary mission of tactical jamming and/or deception of early warning, acquisition, and track-while-scan radar.

d. The major improvements forthcoming in the aircraft posture are the increase in electronic warfare platforms with greater sophistication in detection and jamming capability, and system improvements for greater accuracy and capability in air-to-ground and air-to-air munitions delivery. In all categories of air-to-air, bombing, reconnaissance, re-fueling, and electronic warfare, the major equipment deficiencies and shortages exist in the systems carried aboard the aircraft and not in the availability and characteristics of the aircraft themselves.

~~SECRET~~

EA-4

Annex A to
Appendix E

4. (S) Aircraft Systems Capability Requirements.
Greater accuracy in weapons delivery (day, night, and all-weather) is an urgent requirement not presently limited by the airborne platform, but by the quality and availability of the avionic and ground systems. Systems to increase bombing accuracy (day, night, and all-weather) should be expedited on an urgent basis for incorporation in aircraft now in production.

a. A6A. An increase in all-weather attack capability is required in order to:

- (1) Maintain strike effort during bad weather periods (NVN attack sorties decreased by 48 percent during November and December 1966 as compared to relatively good weather months of August and September).
- (2) Maintain a uniformly distributed and continuous interdiction effort.

An increase in the A6 force levels will help to satisfy the requirement as soon, and as effectively and inexpensively as possible. For instance, analysis indicates that a 33 percent increase in the A6A Carrier Air Wing Complement (from nine to twelve airplanes) results in a 66 percent increase in sorties and a 20 percent increase in sortie rates. The primary factor seems to be that the increase in aircraft does not result in a corresponding increase in aircraft down for supply and maintenance. According to CINCPACFLT* the typical accountability of assigned A6s at the beginning of the flying day is:

	<u>9 A6A</u>	<u>12 A6A</u>
Maintenance Check	1	1
NORS	1	1
Battle Damage (50% of Time)	1	1
Routine Unscheduled Maint. (Airframe, engine, avionics)	1 to 2*	1 to 2*
Up and available for flight	4 to 5	7 to 9

* CINCPACFLT 202228Z Nov 66

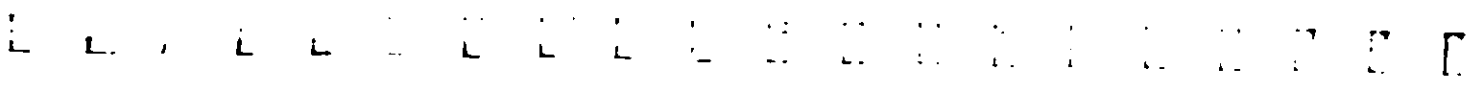

This increased number of available aircraft provides a greater flexibility in meeting schedules resulting in a higher sortie rate as shown in the table below which is an actual comparison between squadrons on YANKEE STATION in 1966 with aircraft of the same configuration and comparable support and training:

Nine versus Twelve A6A Aircraft

	<u>VA 65</u>	<u>VA 85</u>	<u>VA 35</u>	<u>Combined VA 85/35</u>
Number of A6A	12	9	9	9
Days YANKEE STATION	100	56	29	85
Aircraft Days YANKEE	1200	504	261	765
	(100X12)	(9X56)	(9X29)	
Scheduled Sorties	1312	542	263	805
Sorties Flown	1268	418	232	650
Sorties Flown/Day	12.68	7.46	8.00	7.65
Sked Sorties/Aircraft/Day	1.09	1.07	1.01	1.05
Flown Sorties/Aircraft/Day	1.05	0.81	0.89	0.85

The effect of employing the A6A as a pathfinder for the A7 aircraft in marginal weather was examined. This tactic has already been employed in Southeast Asia. The following criteria were used:

Summary of Criteria Used

Weather Conditions and Aircraft Utilization

- VFR - 5000' ceiling/5M: Visibility or better - All attack aircraft may be utilized.
- IFR - 1000' ceiling/1½M: Visibility or worse - Only A6A attack aircraft may be utilized.
- Marginal - Between VFR and IFR - A7 aircraft may be operated with one A6 PATHFINDER per each four A7s.

Conditions A and B

- A - All A6 available for PATHFINDER during marginal weather.
- B - Eight A6 sorties per day reserved for special missions (Condor, ARM, Critical night targets, etc.)

Daily Sortie Rates

- A7A - 1.7 sorties per unit possessed A/C per day (estimated from A4).
- A6A - 9 possessed -- 1.0 sorties per A/C per day.
- 12 possessed -- 1.25 sorties per A/C per day.

Miscellaneous

1.7 hour standard deck cycle and up to 300 mi. combat radius. Increased cycle time and range would reduce sortie totals arithmetically.

F-4 sorties are not included. This omits some small increase in the VFR sorties effort, but would not effect marginal or IFR sorties since these cases are already A6A limited.

Hanoi weather for a 30-day period for both the average annual and worst month (April) was as follows:

	<u>April</u>	<u>Annual</u>
VFR	7	14
IFR	5	3
Marginal	18	13

Sorties generated and the payload carried under the stated criteria were computed. A comparison of the proposed complement of 9 A6As and 42 A7As with a complement of 12 A6As and 28 A7As revealed the following:

		<u>9 A6 + 42 A7</u>		<u>12 A6 + 28 A7</u>	
Condition A	Sorties	1418	6835	1640/+15.6	8130/+17.9
	April			1736/-0.2	8550/+3.2
	Annual Av.	1738	8280		
Condition B	Sorties	842	4230	1287/+52.8	6535/+54.4
	April			1481/+12.0	7410/+15.9
	Annual Av.	1322	6390		

In other words the 33 percent increase in A6s offset the 33 percent decrease in A7As and resulted in a significant increase in sorties generated especially during the month of supposedly worst weather. Although there was some increase in A6A VFR sorties, the greatest gain is due to more efficient utilization of the A7 during IFR and marginal weather. There is no consideration of night versus day in this exercise which would further reduce the A7 effectiveness if operating without a PATHFINDER. Of perhaps equal significance to the gain in effectiveness due to the increase in A6s is the fact that the distribution of the attack effort is more uniform over the range of weather and darkness. The impact of the A6 in Southeast Asia is also portrayed by the following:

Attack Operations
Utilization Analysis

YANKEE STATION January 1967
(CORAL SEA, ENTERPRISE, KITTY HAWK, TICONDEROGA)

	<u>F4</u>	<u>F8</u>	<u>A1</u>	<u>A4</u>	<u>A6</u>
Ave Possessed A/C	50	22	23	82	8.5
Total A/C - Days	1,550	686	713	2,542	264
Strike Sorties	134	22	30	672	216
Armed Recce Sorties	243	89	75	1,312	19
Flak Support Sorties	30	34	---	88	---
Total Attack Sorties	407	145	105	2,072	235
Total Attack Sorties/ Aircraft/Day	.26	.21	.14	.81	.89
Strike Sorties/Aircraft/ Day	.09	.03	.04	.27	.82

The above figures demonstrate the relative effectiveness of A6A in terms of strike and total attack sorties during a poor weather month. The above tables actually discount the total effectivity of the A6A by not taking into account:

(3) Relative effectivity of Armed Recce vs Strikes.

(4) Relative effectivity of A6 vs A4 strike sorties (4:1 payload alone).

~~SECRET~~

(5) Degradation or diversion of visual sorties due to weather.

This consideration is separately developed by CINCPACFLT in an earlier analysis: "During a two month period under consideration. (November - December) a total of 5047 USN ROLLING THUNDER sorties were flown over a period of 154 CVA days (The latter figure does not include stand-downs). Forty-five CVA days were A6A equipped and a total 389 A6A sorties were flown. The two A6A squadrons now in 7th FLT flew nearly eight percent of the total Navy ROLLING THUNDER attack sorties, and expended roughly 25 percent of the ordnance." The above figures reflect the actual value of the A6A in at least two respects. Six hundred fifty three sorties, included in the above totals, were weather diverts into RP I; these were generally radar controlled drops that contributed little to a cohesive interdiction program. Consequently the A6A PROVIDED EVEN A HIGHER FRACTION OF THE NAVY EFFORT THAN INDICATED ABOVE. Moreover, a large number of the total sorties flown in Navy packages were prevented by weather from accomplishing their assigned mission, while A6A ordnance was usually delivered as planned. The requirement in the Navy for an increased allweather attack capability is evident from a DECREASE BY 48 PERCENT OF NVN ATTACK SORTIES DURING NOVEMBER AND DECEMBER AS CONTRASTED TO THE RELATIVELY GOOD WEATHER MONTHS OF AUGUST AND SEPTEMBER 1966. In addition to using the A6 for its all-weather attack alone, the A6 has many advantages such as its use as a SHRIKE delivery vehicle during poor weather conditions. In view of the demonstrated capability of the A6, CINCPACFLT has recommended increasing the squadron complement from nine to twelve A6s and further increasing the complement to 15 once squadron strength of 12 has been achieved. CINCPACFLT also states,* "Many of the more important targets are so heavily defended by flak emplacements and automatic weapons that the cost of aircraft attrition becomes inordinately high during daylight VFR attacks. By using the cover of darkness or adverse weather conditions along with electronic hampering devices, the enemy defenses can

* CINCPACFLT 090037Z Mar 1967

~~SECRET~~

EA-9

Annex A
Appendix E

be considerably nullified." Statistics on relative vulnerability of all aircraft on a day versus night basis are inconclusive. There appears to be no significant difference between day and night losses. However, the A6 attrition rate for 1966 was not significantly different from the loss rate for A4/F4 attack missions despite consistent employment of A6 against the more heavily defended targets. Aircraft damages and losses are even more difficult to assess properly. However, for strikes on North Vietnam during 1966, the following A6A experience was noted:

	<u>Day*</u>	<u>Night</u>
Combat Sorties	2286	1323
Combat Losses	7	3
Loss Rate/1000 Sorties	3.06	2.27
Damage Rate/1000 Sorties	12.6	0.8

Despite the small data base (which represents most of the population) the difference in damage rate, at least, is significant. It is also quite possible that if the data could be appropriately broken down into day VFR and Night/IRF** categories there would be a more significant difference in both losses and damages.

It is interesting to note that in almost three years of fleet operation, the A6A has not suffered a carrier landing accident. It is generally credited with the best carrier suitable flying characteristics of any jet aircraft in the fleet. Perhaps one of the most important advantages of the A6 is its capacity for expansion and growth giving it the capability of absorbing the space and weight requirements for new sensors and weapons such as LLLTV, FLIR, Standard Arm, and Condor. The Navy is at present attempting to gain approval for an increase in the A6A force level. This effort should be supported.

* Includes both day visual and IFR sorties. All losses were under visual conditions.

** A very small sample of sortie data from OPREP 4s indicates that A6A night targets are as hard, based on route package location, as their day targets.

b. EA6A/B. Advances in air defense systems primarily associated with electronic equipments have posed an ever increasing threat to the survivability of strike aircraft. Defensive electronic penetration aids and countermeasure equipment have long been a requirement in strategic, deep strike and reconnaissance aircraft, but this requirement has seldom been adequately met. The effective air defense system of North Vietnam, especially in RP V and V-, has served to focus long needed attention on the requirement for ECM on tactical strike aircraft. The significant decrease in aircraft loss rates evidenced in both the Navy and the Air Force, as discussed elsewhere in this report, attests to the effectiveness of our, so-far limited, ECM efforts, and supports the requirement for autonomous protection and for specially configured electronics warfare aircraft. The autonomous ECM capability, whether jamming or deceptive, is optimized against the point defense system. The current threat spectrum is broader and more sophisticated than can be handled automatically by the single pilot strike aircraft. Specifically, an airborne ECM operator is needed to assist in detecting and analyzing hostile electromagnetic signals and to then select an immediate jamming or deceptive response; hence the requirement for specially configured electronic warfare aircraft. In order to provide this necessary support for strike aircraft today, we are faced with improvising through the use of airframes that are old and are not performance compatible with the aircraft to be supported and whose jamming equipment is of such low power that they are only minimally effective. Neither the quality nor the quantity of ECM assets have kept pace with the rising effectiveness of air defense systems. The WILD WEASEL (F-105F) program is certainly a step in the right direction; however, the inventory of Navy electronic warfare aircraft is confined, with a few exceptions such as the EA3B and EF-10B reciprocating engine EA-1F and EC-121M aircraft equipped with a detection and jamming capability which is little better than WWII state-of-the-art. It is, therefore, necessary to confine the use of these aircraft to operations against a very small portion of the threat spectrum,

~~SECRET~~

and in a stand-off role in a prepositioned location which will be traversed by strike aircraft proceeding to or returning from a target area. The EF10-B EW aircraft was deployed to Southeast Asia with the Marine Corps in April 1965 even though it was 15 years old and the service life had to be further extended. Notwithstanding the limited capability of these aircraft, the effectiveness which they have provided in support of current Southeast Asia operations has amply demonstrated the validity of the concept involved and the requirement to improve and increase the force levels of EW aircraft. In 1963, the Marine Corps was authorized to procure 12 EA6As, to replace the EF-10B. These 12 EA6As were delivered in mid 1965 and five were almost immediately deployed to Southeast Asia. The remaining seven were retained in CONUS to provide a training base and to meet depot maintenance requirements. Efforts to increase the assets have been fruitless. The EA6A fulfills the specially configured EW aircraft concept by providing an extensive passive and active ECM capability, which can accompany and protect single or multiple elements of strike aircraft into the immediate target area during all conditions of visibility and weather. In order for the Marine Corps to meet the increasing EW requirements of CTF 77 and in the DMZ and in RP I, and to make its entire force structure as well as the EA6A force structure more operationally cost effective at least 15 additional EA6A aircraft systems are urgently needed. Of these 15 aircraft, 12 would immediately augment Southeast Asia operating and pool aircraft, and three would be allocated as attrition replacement aircraft. No increase would be required in the seven aircraft now in CONUS. The Navy, in considering the mix of capability which must be provided to the Carrier Air Wing, determined that a minimum of four EW aircraft per wing was necessary. Past decisions, right or wrong, are now being implemented and the EA6B is currently under development for the Navy and no EA6As are being procured. Many improvements over the EA6A will be achieved, including, automatic detection and analysis of electronic emissions, coordinated and selective use and control of

~~SECRET~~

EA-12

Annex A to
Appendix E

active jammers to reduce interference, narrow bandwidth jammers with steerable antennas to increase effectiveness, etc. A concerted effort is now being made by the Navy to increase the EA6B force level. This effort should be supported and in addition the development should be accelerated since a definite gap now exists in a vital requirements area.

5. (S) Aircraft Survivability

a. While changes in tactics, increased use of electronic warfare, flak suppression, and other techniques may reduce the probability of aircraft being hit by enemy fire, we could further reduce aircraft losses by concentrating on increasing the survivability of aircraft which are hit.

b. Several studies have been made in this area on the RF/F-4C, F-105, and RF-101. With specific instructions to disregard efforts which would reduce the chances of the aircraft being hit, the manufacturers of each of the above aircraft were asked to recommend actions which would increase the survivability of their aircraft assuming they were hit by munitions ranging from 7.62mm to 37mm high-explosive incendiary shells with striking velocities up to 4000' second. Recognizing that efforts to reduce an aircraft's vulnerability usually resulted in penalties incurred in weight, drag, fuel capacity, maneuverability, range and/or cost, the studies cited above analyzed each recommendation to increase survivability in terms of its effectiveness in relation to costs and other penalties.

c. The studies categorized aircraft damages as: (1) that which would cause the aircraft to go out of control within five seconds after being hit (very low chance of pilot recovery although loss of aircraft) (2) out of control within five minutes (some chance of pilot recovery although loss of aircraft) and (3) damage which would allow the aircraft to proceed no more than 100nm and land, but aircrew recovery is high. Obviously, the most productive improvements are those which would prevent or decrease the causes which place an aircraft in the first two categories.

~~SECRET~~

However, fire and explosion and loss of flight controls are the most common hazards in categories one and two, accounting for approximately 75 percent of all losses. Fuselage tanks, though less vulnerable than wing tanks, offer the increased hazard of fuel leaks within the internal engine and airframe sections. The vulnerability of any fuel tank increases greatly as fuel is used from it. Several of the studies concluded, therefore, that a tank filler such as RETICULATED FOAM (SECRET) had the greatest potential for reducing explosions with the minimum performance penalties and the highest ratio of effectiveness to cost. Specifically, for the F-4C, it was concluded that the above modification, along with a self-sealing number one tank, armor for the hydraulic bay area, and electrical/hydraulic back-up packs, could yield a 48 percent reduction in loss rate with a 221 pound increase in take-off weight.

The Republic Aircraft Division of Fairchild Hiller has similarly concluded that a modification package on the F-105 consisting of (1) self-sealing tank and internal filler, (2) third hydraulic system, (3) external void filler, (4) bomb bay, engine access, and shroud fire extinguishers, (5) minimum armor for crew, and (6) revised fuel system plumbing could yield a 73 percent reduction in the aircraft's vulnerability to small arms and light AAA. The total weight penalty is approximately 1,380 pounds and rough cost estimates are \$46,000 per aircraft.

d. With F-4 replacement costs approximately \$2.5 million, these modifications should be evaluated with minimum delay and those deemed to have a high potential of effectiveness in relation to their costs and performances penalties should be implemented on an urgent expedited basis.

e. The conclusions of the above studies further indicate that changes in fuel management procedures may greatly reduce the fire and/or explosion hazard by allowing only the least vulnerable tanks to be less than full in areas of the greatest concentration of flak.

~~SECRET~~

AIRCRAFT DEPLOYMENT SCHEDULES^{a/}

US NAVY

US AIR FORCE

a/ See Tables 1 and 2

EA-15

Annex A to
Appendix E

TABLE 1

U S A DEPLOYMENT SCHEDULE

	1967												1968											
	APR	MAY	JUN	JUL	AUG	SEP	OCT	NOV	DEC	JAN	FEB	MAR	APR	MAY	JUN	JUL	AUG	SEP	OCT	NOV	DEC			
CORAL SEA																								
ORISKANY																								
BON HOWAR RICHARD																								
TICONDEROGA																								
KITTY HAWK																								
ENTERPRISE																								
HARCOCK																								
RANGER																								
CONSTELLATION																								
INTREPID																								
FORRESTAL																								
AMERICA																								

CHARACTERISTICS FOR NAVY AIRCRAFT
CURRENTLY IN SOUTHEAST ASIA ^{a/}

A-1H/J
A-4B/C/J
A-6A
F-4B
F-8E
RA-3B
RF-4B
RF-8A/G
RA-5C

E-1B
E-2A
EA-1F
EA-3B
EA-6A
EC-121
EF-10B
EKA-3B

a/ See Tables 3 through 21

EA-16

Annex A to
Appendix E

~~SECRET~~

TABLE 2

U S A F AIRCRAFT DEPLOYMENT

SOUTH VIETNAM

BASE	AIRCRAFT TYPE	MAR 1967	DEC 1967	JUL 1968
CAN RANH BAY	F-4C	72	72	72
DA NANG	F-4C	54	54	54
	C-130		6	6
KHA TRANG	EC-47	15	15	15
TAN SON NHUT	RF-4C	36	52	52
	RF-101	16	0	0
	EC-47	17	17	17
PLEIKU	EC-47	15	15	15

THAILAND

KORAT	F-105	72	36	36
	F-4D		36	36
NAM PHONG	EC-121		21	21
TA KHLI	F-105	54	54	54
	EB-66B	13	13	13
	EB-66C	15	15	15
	KC-135	10	10	10
UBON	F-4D		18	18
	F-4C	54	36	36
	EC-121	4	6	6
UDORN	F-4D		18	18
	RF-4C	24	24	24
	RF-101	16	16	16
U-TAPAO	KC-135	25	25	25
	B-52		15	15
	KC-135 (Radio Relay)	2	5	5
	EC-121D	4	4	4

~~SECRET~~

EA-15b

Table 2 to
Annex A to
Appendix E

TABLE 4

MISSION AND DESCRIPTION																								
<p>The A4B airplane is a lightweight, high-performance, carrier-based, jet-powered attack airplane designed for dive, glide and loft bombing, and interdiction. The airplane is also capable of Bullpup missile attacks and in-flight refueling as a tanker or a receiver. It can operate from CVS and CVA type carriers.</p> <p>The arrangement is conventional with all-metal monocoque structure and three-spar low aspect-ratio wing. Landing gear, flaps and speed-brakes are hydraulically operated. An electrically operated fully adjustable stabilizer is used to trim throughout the normal flight range. The aileron, elevator, and rudder system are hydraulic-power operated. Manual control is provided for emergencies.</p> <p>This airplane does not have folding wings. The aft section of the fuselage is readily removable to permit quick engine change. Pressure fueling is provided.</p>																								
OPERATING DATA		AVAILABILITY/DEVELOPMENT																						
<p>Vmax S.L. 563 kts. Ferry range 1580 N.M. Ceiling (S) 40,200 ft. Time on Sta. (150 mi.) 1.5 hr./ No. per CVA/MCW 24/30</p> <p>5000' 12 MK 81</p>		<p>First Flight.....March 1955 Service Use.....July 1957</p> <p>Inventory FY 67 FY 68 FY 69 FY 70 281 183 15 8</p>																						
WEIGHTS		FUEL AND OIL		DIMENSIONS																				
<p><u>LOADINGS</u></p> <p>Empty 9146 Basic 10,032 Flight Des. 12,504 Combat 15,359 Max. T.O. 22,500 Max. Land. (Arrest) 13,000 (Airfield) 16,000</p>	<p><u>WEIGHT</u></p> <p><u>L.F.</u></p> <p>7.0 5.7 3.9 6.7 5.5</p>	<p><u>NO. TANKS</u></p> <p>1 1</p> <p><u>GAL.</u></p> <p>563 237</p> <p><u>LOCATION</u></p> <p>Wing Fuselage</p> <p>OIL</p> <p>3.2 gal. mounted on engine 4.0 gal. after ASC-118 incorp. Oil Spec.....MIL-L-7808</p>	<p>Span.....27.5 ft. Length.....40.1 ft. Height.....15.0 ft. Max. Tread.....7.8 ft. Turn. Rad. (Nose).....29.5 ft. Wing Area.....260 sq. ft.</p>																					
ELECTRONICS			ORDNANCE																					
<p>AN/ASQ-17 Electronic Control Central providing the following:</p> <table border="0"> <tr> <td><u>Function</u></td> <td><u>Equivalent to</u></td> </tr> <tr> <td>UHF Comm.</td> <td>AN/ARC-27</td> </tr> <tr> <td>IFF</td> <td>AN/APX-6B</td> </tr> <tr> <td>SIF</td> <td>AN/APA-89</td> </tr> <tr> <td>UHF ADF</td> <td>AN/ARA-25</td> </tr> </table> <p>Self Contained Navigation AN/ASN-19A (Dead Reckoning Computer)</p> <p>TACAN.....AN/ARN-21 LAHS.....AERO. 18B Store Arming.....T-249 Hullput (System).....ASM-N-7A Data Link.....AN/APW-67 Radar Beacon.....AN/APN-132 SHOEHORN Alfa.....ALQ-51B/ APR-27B/ AN/APR-30M2/ AN/ALE-29B/</p>			<u>Function</u>	<u>Equivalent to</u>	UHF Comm.	AN/ARC-27	IFF	AN/APX-6B	SIF	AN/APA-89	UHF ADF	AN/ARA-25	<p>Store Station</p> <table border="0"> <tr> <td><u>NO.</u></td> <td><u>LOCATION</u></td> <td><u>LOADING</u></td> </tr> <tr> <td>1</td> <td>Fuselage</td> <td>To 3575 lbs.</td> </tr> <tr> <td>2</td> <td>Inbd. Wing</td> <td>To 2240 lbs.</td> </tr> </table> <p>Guns - 2 MK-12 20mm Launchers - LAU-3A/A, LAU-10/A Bombs - MK-81, 82, 84, 81 Snakeye, 82 Snakeye, MK 79/77-1, Firebomb Bullpup A(-12B), B(-12C) Shrike Rockeye II Walleye Sadeye CBU Mk 4 Gun Pod</p>			<u>NO.</u>	<u>LOCATION</u>	<u>LOADING</u>	1	Fuselage	To 3575 lbs.	2	Inbd. Wing	To 2240 lbs.
<u>Function</u>	<u>Equivalent to</u>																							
UHF Comm.	AN/ARC-27																							
IFF	AN/APX-6B																							
SIF	AN/APA-89																							
UHF ADF	AN/ARA-25																							
<u>NO.</u>	<u>LOCATION</u>	<u>LOADING</u>																						
1	Fuselage	To 3575 lbs.																						
2	Inbd. Wing	To 2240 lbs.																						
<p>Will be in only 20 aircraft</p>																								

TABLE 5

MISSION AND DESCRIPTION														
<p>The A-4C airplane is a lightweight, high-performance, carrier-based, jet-powered attack airplane capable of dive, glide and loft bombing, in-flight refueling (tanker or receiver), carrying an air-to-surface missile and firing conventional guns and rockets. It can operate from CVS and CVA type carriers. Limited all-weather navigational aids are provided.</p> <p>The arrangement is conventional with all metal semi-monocoque structure and three spar low aspect-ratio wing. Landing gear, flaps and speed-brakes are hydraulically operated. An electrically operated, fully adjustable stabilizer is used to trim throughout the normal flight range. The aileron, elevator, and rudder systems are hydraulic-power operated. Manual control is provided for emergencies. An automatic flight control system is provided for pilot relief.</p> <p>The small size of the airplane precludes the need for folding wings. The aft fuselage is readily removable to permit quick engine change.</p>														
OPERATING DATA			AVAILABILITY/DEVELOPMENT											
Vmax S.L. 561 kts. Ferry range 1560 N.M. Ceiling (S) 39,500 ft. Time on Sta. (150 mi.) 1.5 hr. No. per CVA/MCW 24/30 a/ 5000* (12) MK 81			First Flight.....August 1958 First Fleet Delivery.....February 1960 Inventory FY 67 FY 68 FY 69 FY 70 331 277 293 252											
WEIGHTS		FUEL AND OIL		DIMENSIONS										
LOADINGS Empty 9728 Basic 9933 Flight Des. 12,504 Combat 15,528 Max. T.O. 22,500 Max. Land. (Arrest) 14,500 (Airfield) 16,000	L.F. 7.0 5.7 3.9 6.0 5.5	TANKS 1 570 1 240 In-flight fueling provided. OIL 3.2 Gal. mounted on engine 4.0 gal. after ASG-118 incorp. Oil Spec.....MIL-L-7808	LOCATION Wing Fuselage In-flight fueling provided. OIL 3.2 Gal. mounted on engine 4.0 gal. after ASG-118 incorp. Oil Spec.....MIL-L-7808	Span.....27.5 ft Length.....39.4 ft Height.....15.0 ft Max. Tread.....7.8 ft Turn. Rad. (Nose).....20.5 ft Wing Area.....260 sq. ft										
ELECTRONICS			ORDNANCE											
AN/ASQ-17B Electronic Control Central providing the following: UHF Comm.....AN/ARC-27 IFF.....AN/APX-6B SIF.....AN/APA-89 UHF ADF.....AN/ARA-25 Self Contained Navigation (Dead Reckoning Computer).....AN/ASN 19A TACAN.....AN/ARN-21 LABS.....AJ B-3 Store Arming.....T-249 Bullpup (System).....ASN-N-7A Radar.....APG-53A Data Link.....ARW-73 or ARW-67 Shoehorn ALFA.....PLQ-51A/ APR-27A/ ALE-29A/ APR-23A/ APR-30A/ Auto Pilot.....ASN-54W a/ 60% of aircraft			Store Stations <table border="1"> <thead> <tr> <th>NO.</th> <th>LOCATION</th> <th>LOADING</th> </tr> </thead> <tbody> <tr> <td>1</td> <td>Fuselage</td> <td>To 3575 lbs.</td> </tr> <tr> <td>2</td> <td>Inbd. Wing</td> <td>To 2240 lbs.</td> </tr> </tbody> </table> Guns - 2 MK-12 20mm Launchers - LAU-3A/A, LAU-10/A Bombs - MK 81, 82, 83, 84, 81 Snakeye, 82 Snakeye, MK 79/77-1 Firebomb Bullpup A(-12B), B(-12C) Sbrake Rockeye II Waller Sadeye CBU MK 4 Gun Pod			NO.	LOCATION	LOADING	1	Fuselage	To 3575 lbs.	2	Inbd. Wing	To 2240 lbs.
NO.	LOCATION	LOADING												
1	Fuselage	To 3575 lbs.												
2	Inbd. Wing	To 2240 lbs.												

TABLE 6

MISSION AND DESCRIPTION														
<p>The A-4E is a lightweight, high performance, carrier-based, jet powered attack airplane capable of dive, glide and loft bombing in-flight fueling (tanker or receiver), carrying an air-to-surface missile, and firing conventional guns and rockets. It can operate from CVS and CVA type carriers. Limited all-weather navigational aids are provided. The A-4E is an A-4C with a J52 engine and two additional wing weapon stations.</p> <p>The arrangement is conventional with all-metal semi-monocoque structure and three-spar low aspect-ratio wing. Landing gear, flaps and speed brakes are hydraulically operated. An electrically operated, fully adjustable stabilizer is used to trim throughout the normal flight range. The aileron, elevator, and rudder systems are hydraulic-power operated. Manual control is provided for emergencies. An automatic flight control system is provided for pilot relief.</p> <p>The small size of the airplane precluded the need for folding wings. The aft fuselage is readily removable to permit quick engine change.</p>														
OPERATING DATA			AVAILABILITY/DEVELOPMENT											
<p>Vmax S.L. - 574 kts. Ceiling (S) - 40,400 ft. No. on CVA/MCV - 24/30 Ferry range - 1856 N.M. Time on Sta. (150 mi.) - 1.75 hr. ^{a/}</p> <p>^{a/} 5000⁺ 12 MK 81</p>			<p>Navy Authority to Proceed.....1 June 1960 First Flight.....12 July 1961 Fleet Delivery.....December 1962</p>											
			<p>Inventory FY 67 FY 68 FY 69 FY 70 276 228 197 177</p>											
WEIGHTS		FUEL AND OIL		DIMENSIONS										
LOADINGS	LBS	L.F.	NO.	GAL.	LOCATION									
Empty (E)	9624		TANKS											
Basic	10,391		1	560	Wing									
Flight Design	12,504	7.0	1	240	Fuselage									
Combat	16,135	5.4	In-flight fueling provided.											
Max. T.O.	24,500	3.6	OIL											
Max. Land.			5.0 Gal. mounted on engine											
(Arrest)	14,500	6.0	Oil Spec.....MIL-L-7808											
(Airfield)	16,000	5.5												
				<p>Span.....27.5 ft. Length.....41.3 ft. ^{a/} Height.....15.0 ft. Max. Tread.....7.8 ft. Turn. Rad.....20.5 ft. ^{a/} Wing Area.....260 sq. ft.</p>										
				<p>^{a/} Without refueling probe</p>										
ELECTRONICS			ORDNANCE											
<p>Electronics Central AN/ASQ-17B Consisting of:</p> <p>UHF Communications AN/ARC-27 IFF-AN/APX-6 SIF-AN/APN-89 AN/ARA-25</p> <p>Elect. Altimeter.....AN/APN-141(V) Navigation Set.....AN/APN-153(V) TACAN.....AN/ARN-52 NAV. Computer.....AN/ASN-41 UHF Direction Finder.....AN/ARA-25 Radar.....AN/APG-53A G/M Guidance.....AN/ARM-73 LABS.....AN/AJB-3A Auto. Pilot.....AN/ASN-54(V) SHOEHORN ALFA.....AN/ALQ-51B AN/APR-27B AN/APR-23A AN/ALE-89A AN/APR-30MB</p> <p>^{a/} 60% of aircraft</p>			<p>Store Stations</p> <table border="1"> <thead> <tr> <th>NO.</th> <th>LOCATION</th> <th>CAPACITY</th> </tr> </thead> <tbody> <tr> <td>1</td> <td>Fuselage</td> <td>3575 lbs.</td> </tr> <tr> <td>2</td> <td>Inbd. Wing</td> <td>2240 lbs.</td> </tr> </tbody> </table> <p>Guns - 2 MK-12 20mm Bombs - MK 81, 82, 83, 84, 81 SNAKEYE, 82 SNAKEYE, MK 79/77-1 Firebombs, MK-94 Chemical Bomb Launches - LAU-3, LAU-32, LAU-10 CBU - 1, 2, 3 Bullpup - A(-12B), B(12C) Shrike Rockeye II Walleye Sadeye MK 4 Gun Pod</p>			NO.	LOCATION	CAPACITY	1	Fuselage	3575 lbs.	2	Inbd. Wing	2240 lbs.
NO.	LOCATION	CAPACITY												
1	Fuselage	3575 lbs.												
2	Inbd. Wing	2240 lbs.												

~~SECRET~~

TABLE 7

MISSION AND DESCRIPTION							
<p>The A-6A is a medium size, all weather low altitude two-place attack aircraft capable of high subsonic performance and broad mission versatility including tanker capability.</p> <p>At light gross weights it can operate from short unprepared fields, in close support of ground troops, while at higher gross weights, it can operate from C11-1 catapults on long range special weapons strikes against heavily defended fixed targets.</p> <p>An integrated attack-navigation and central digital computer system is provided to find, track and destroy small moving targets and large fixed targets in all weather conditions. HUD displays provide contact analogue, terrain clearance, attack and horizontal situation information in integrated form. Five store stations are provided, inboard of the wing fold point.</p> <p>Irreversible hydraulic flight controls are provided. Longitudinal control is effected by an all movable stabilizer. Lateral control is provided by flaperons while a conventional rudder is used for direction control.</p>							
OPERATING DATA		AVAILABILITY/DEVELOPMENT					
Vmax.....561 kts. Ceiling (C).....41,000 ft. No. per CVA/MAW.....12/30 Ferry route Time on Sta. (150 mi.) 12 SNAKEYE.....3 hr. 30 min. 14 SNAKEYE.....2 hr. 45 min. 30 SNAKEYE.....1 hr. 50 min.		First Flight.....April 1966 Service Use.....Summer 1963 Inventory FY 67 FY 68 FY 69 FY 70 120 187 220 220					
WEIGHTS		FUEL AND OIL		DIMENSIONS			
LOADINGS	LBS	L.F.	No.	TANKS GAL.	LBS.	LOCATION	Wing
Empty	25,298		3	1326	9016	Fuselage	Area.....528.9 sq. ft.
Basic	25,857	6.5/5.8A	5	1018	6923	Wings	Span.....53 ft. 0 in.
Design	36,526		5	1477	10,045	Drop Tanks	MAC.....130.8 in.
Combat	44,791		(300 gal.)				Sweepback (1/4 chord)....25°
Max. T.O. (Field)	60,400						Length.....54 ft. 9 in.
(Cat)	58,600						Height.....16 ft. 2.040 in.
Max. Land. (Field)	33,500						Tread.....11 ft. 0.3 in.
(Arrest)	33,500						
a4 Tip brakes extended							
ELECTRONICS				ORDNANCE			
ATTACK-NAVIGATION-INSTRUMENTS MA-1 Compass System Air Data Computer.....CF729/A Digital Computer (Diane).....AN/ASQ-61 Search Radar.....AN/APQ-92 Track Radar.....AN/APQ-112 Doppler Radar.....AN/APN-153 Inertial Platform.....AN/ASN-31 Radar Altimeter.....AN/APN-141 Bullpup Transmitter.....AN/ARW-73 Integrated Display Subsystem APDS.....AN/ASW-16				Maximum Bomb Capacity: 18,000 lbs. Bombs: MK 81, MK 82, MK 83, MK 84, Fire Bombs, MK 79 Mod-1, MK 77 Mod 1, 260 lb. Fragmentation, MK 81 Snakeye 1, MK 82 Snakeye, MK 94 Chemical Special Weapons: MK 28 Ex Mod-1, MK 57, MK 43, MK-104 Rocket Package: LAU-32A/A, LAU-3A/A, LAU-10A/A Mines: MK 36, MK 50, MK 52 Missiles: AGM-128, AGM-12C (Bullpup A&B), AGM-45A (Shrike), AIM-9D (Sidewinder)			
COMMUNICATIONS COM Package.....AN/ASQ-57 UHF ADF.....AN/ARA-50 UHF Rec. Transmitter.....AN/ARC-52 UHF Stand-by Rec.....AN/ARR-40 IFF.....AN/APX-68 IFF Coder.....AN/APA-89(SIF) TACAN.....AN/ARN-21A ICS.....AN/AIC-14 Data Link.....AN/ARW-67				In addition the following may be carried: MER/TER Racks, CBU-2A/A Aircraft Dispenser A Bomblets, A/A-37R-1 Multiple Bomb Rack, Aero 5A-1 Launcher, A/A-37B-3 Practice Multiple Bomb Rack with MK 106 Mod-3 or MK 76 Mod-5 Practice Bombs, MK 6 Mod-6 Flare, MK 24 Mod-2A Flare			
COUNTER MEASURES INCM.....AN/ALQ-41 INFTM.....AN/ALQ-51 Chaff Dispenser.....AN/AIE-18 Warning Receiver.....AN/AIR-15 Warning Receiver.....AN/AIR-27							

~~SECRET~~

EA-16e

Table 7 to
Annex A to
Appendix E

TABLE 8

MISSION AND DESCRIPTION					
<p>The F-4B is a two-place, twin-jet, general purpose fighter whose primary mission is the destruction of enemy aircraft. The capability to carry and deliver conventional and special weapons enables the aircraft to perform intermediate and long range attack missions. Basic armament is four air-to-air missiles carried semi-submerged under the fuselage plus up to four wing pylon mounted air-to-air missiles. A combination of conventional bombs, nuclear bombs, rocket packages and fuel tanks can be carried on five stations beneath the wing and fuselage. Three external tanks plus a retractable probe for inflight refueling provides for extended range missions.</p> <p>Special features of the F-4B are the swept wing and tail, automatically controlled compression-ramp air inlets, leading and trailing-edge high-lift flaps with boundary layer control. Lateral control is achieved by means of spoilers in combination with ailerons. An all-movable stabilizer provides longitudinal control.</p>					
OPERATING DATA		AVAILABILITY/DEVELOPMENT			
Vmax.....2.23 MN Ceiling.....56,850 ft. No. on CVA/MCM 24/30.....24/30 Ferry range.....1803 N.M Time on Sta (150 mi.).....1.33 hrs.▲		First Flight.....May 1958 Service Use.....June 1961			
▲ / 4 SP III/4 SW/1 Tank		Inventory FY67 68 69 70 408 307 269 274			
WEIGHTS		FUEL AND OIL		DIMENSIONS	
LOADING Empty 27897 Basic 28265 Design 37500 Combat 38507 Max. T.O. (Field) 54800 (Cat) 54800 Max. Land (Field) 38000 (Arrest) 38000 a/ Supersonic	LBS L.F. 8.5/6.5▲ 8.3/6.3	NO. TANKS 6 2 1 2 OIL Integral with Engine 5.15 Gal (Tank Capacity per Engine) Specification....MIL-L-7808D	GAL 1356 630 600 740	LOCATION Fuselage, Bladder Wings, Integral Fuselage, Ext, Drop Wing, Ext, Drop	Wing Area.....530 Sq. Ft. Span.....38.4 Ft. M.A.C.....16.04 Ft. Sweepback (27° Chord)....45° Incidence.....1° Dihedral - Inner 0° Outer Panel...12° Length.....58.2 Ft. Height.....16.3 Ft. Wheelbase.....23.3 Ft. Tread.....18.2 Ft.
ELECTRONICS			ORDNANCE		
CADC.....A/A24G CNI.....AN/ASQ-19 AFCS.....AN/ASA-32 Nav Computer.....AN/ASN-39 Altimeter.....AN/APN-141 Fire Cont Sys.....AMCS AERO-1A Includes Radar.....AN/APQ-72 Radar Set Group.....AN/APA-157 IR Detecting Group.....AN/AAA-4 All-Altitude Bombing Sys.....AN/AJB-3A Space Provisions for installation.AN/ASW-21() of Data Link* Warning Set.....APR-30() Warning Set.....APR-27() Chaff Dispenser.....ALE-29() ECM Set.....ALQ-51 or ALQ-100() ECM.....ALQ-91() *Data Link installed in 12 airplanes. ** IFF Interrogator APX-76() *** IFE (Interim Interrogator) GAINTIME ** Presently installed in 12 A/C VF213 Deployed *** Presently installed in 24 A/C VF 92/93 deployed			Four Sparrow III Missiles on Fuselage Fus In'bd. Out'Bd. CL Wing Wing Air-to-Air Missiles Sparrow III 2 Sidewinder 4 Special Weapons MK-28 (EX) 1 MK-43 1 MK-57 1 Conventional Bombs MK-81 6 6 12 MK-82 6 6 12 MK-83 3 4 4 Rocket Packages Aero 7D(19 2.75" Rockets per Pkg.) 3 6 6 LAU LOA (4 5.00" Zuni Rockets per Package) 3 6 6 Practice Dispenser Aero 8A 1 Gun Pod MK-4 1		

TABLE 9.

MISSION AND DESCRIPTION			
<p>The F-8E (F8U-PNE) is a single-seat, carrier based jet fighter designed to maintain air superiority during task force strikes and as an attack fighter capable of delivering conventional stores of various types and sizes. The airplane is a development of the F-8D (F8U-2N) with increased armament capabilities and improved ability to detect and destroy targets at night and under all weather conditions. The primary improvements distinguishing the F-8E are: (1) APQ-96 radar for improved detection and attack capability and (2) provisions for mounting stores of various types and sizes on wing pylons. The basic F-8E is the same as the F-8D externally except for the larger nose cone required to accommodate the improved radar and equipment fairing on the wing top centerline in the dorsal area.</p>			
OPERATING DATA		AVAILABILITY/DEVELOPMENT	
Vmax.....1.8 MM/775 KIAS Ceiling.....52,350 feet No. on CVA/ACW.....24/30 Ferry range.....1350 N.M. Time on Sta (150 mi).....1.14 hrs. a/		Inventory a/ FY67 68 69 70 F8E/J 108 37/6 0/74 0/56	
a/ Guns/4 SW		a/ Pipelng not incl. R&D project A/C incl. Bailed A/C not incl.	
WEIGHTS	FUEL AND OIL	DIMENSIONS	
LOADING Empty.....17,836 LBS Basic.....18,423 LBS Design.....26,000 LBS Combat (Guns Incl) 4 G/W.....26,098 LBS 2 MK-84 Bobs.....29,191 LBS 8 Zuni 18 MK-81 Bobs.....30,742 LBS 8 Zuni 18 MK-81 Bobs.....29,232 LBS MAX T.O. Field/Ships.....34,100 LBS MAX Land. Field.....26,000 LBS MAX Land. Ship.....2,000 LBS	LF 514 245 589 Fuel cap us'bl 1348Gal/9,166lb Fuel Spec MIL-F-5624C Fuel Grade JP-5 Oil cap tot 8.5Gal us'bl 3.0GI Oil Spec MIL-L-7908C	LOCATION Fuselage, bladder main system Fuselage, bladder transfer system Wing integral, transfer system 1348Gal/9,166lb MIL-F-5624C JP-5 8.5Gal us'bl 3.0GI MIL-L-7908C	
		Wing Area.....375 sq. ft. Span.....35'8" M.A.C.....141.0" Sweepback & Chord.....42° Length.....55'11.6" Height.....15' 9.1" Tread.....9' 8"	
ELECTRONICS		ORDNANCE	
INTEGRATED ELECTRONIC CENTRAL.....AN/ASQ-17B (contains functions of AN/ARC-27A, AN/APX-6B and AN-ARA-25) CODER GROUP.....AN/APA-89 RADIO SET (TACAN).....AN/ARN-52 RADAR ALTIMETER.....AN/APN-32 GYRO STABILIZED MAGNETICALLY SLAVED COMPASS.....MA-1 ARMAMENT CONTROL SYSTEM.....AN/AWG-1 (includes AN/APQ-96, Radar Set and EX-16, Aircraft Fire Control System) AUTOPILOT.....CV/AES-6 I.R. SYSTEM.....AN/AAS-15 FUSELAGE CONTROL.....AN/AW-1 SPECIAL WARNING RECEIVER.....AN/APR-27 DECM.....AN/AIQ-51 CHAFF DISPENSER.....AN/ALE-29 Warning Set.....AN/APR-3QW()		No. DESCRIPTION LOCATION 4 20-MM Aircraft Guns, Fuselage MK-12 Front Section 500 20-MM Ammunition Rounds 2 or 4 Sidewinder Air-To-Air Missiles Carried Each side of Fuselage Externally on Pylons 4 or 8 Zuni Air-To-Ground Missiles Carried Each side of Fuselage Externally on Pylons 8 MK 81 Bombs Carried Wing Pylons Externally on Pylons 8 MK 82 Bombs Carried Wing Pylons Externally on Pylons 2 MK 83 Bombs Carried Wing Pylons Externally on Pylons 2 MK 84 Bombs Carried Wing Pylons Externally on Pylons	

SECRET

TABLE 10

MISSION AND DESCRIPTION					
<p>The RA-3B airplane is a long range, high performance photographic-reconnaissance airplane for day and night missions. The airplane operates from land bases and from carriers. It is a conventional, swept-wing airplane with two turbo-jet engines enclosed in under-wing nacelles. Normal crew consists of three: a pilot, a photoreconnaissance pilot and a photo technician-runner.</p> <p>The tricycle landing gear, arresting gear, wing-fold and tail-fold mechanisms, single-slotted wing flaps, fuselage speed brakes, and power mechanisms for sudder, elevator and ailerons are operated by hydraulic power. The horizontal stabilizer is adjustable for trim in-flight. Leading-edge slats are actuated automatically by aerodynamic loads. Anti-skid braking is provided. The JATO installation accommodates twelve bottles. The cockpit and camera compartment are pressurized to 7.5 P.S.I. differential.</p> <p>Photographic provisions consist of the pressurized camera compartment with twelve camera stations. The compartment also houses camera controls, camera door controls and film storage.</p>					
OPERATING DATA			AVAILABILITY/DEVELOPMENT		
Vmax S.L. 555 Kts. Ceiling (S) 38,900 feet No. on CVA/HCW Ferry range 2370 N.M. Time on Sta. (150 mi.) 4.5 hr.			Contract: NOa(s) 55-205. 5 Airplanes First Flight: July 1958 Contract: NOa(s) 57-181. 25 Airplanes First Fleet Delivery: August 1959 Inventory FY 67 FY 68 FY 69 FY 70 19 18 16 -		
g/5000' retain tank					
WEIGHTS		FUEL AND OIL		DIMENSIONS	
LOADING	LBS	L.F.	GAL.	No. Tanks	Location
Empty	40,852		3114	2	Fuselage
Basic	41,617		3293	2	
Destin	55,942	3.40	4412		
Combat	61,608	3.09			
Max T.C. (land)	78,000	2.44	Fuel Grade JP-4 or JP-5		
Max T.P. (Cat)	73,000	2.60	Fuel Spec MIL-F-5624		
Max Land(land)	56,000		/ Self-sealing		
Max Load (Car)	50,000		OIL		
			GAL.	No. Tanks	Location
			11	2	Integral
			Oil Spec...MIL-L-7808 with eng		
Wing Area 79 sq. ft.			Span 7.25 ft.		
MAC 140.14 in.			Sweepback 36°		
Length 74.7 ft.			Height 22.8 ft.		
Tread 10.4 ft.					
ELECTRONICS			ORDNANCE		
UHF Homing AN/ARR-40 VHF Trans-Receiver AN/ARC-27A IFF Transponder AN/APX-6B & APA-89 Radio Altimeter AN/APN-22 TACAN AN/ARN-21 HF Receiver AN/ARC-18 Radio Compass AN/ARM-6 Search Radar AN/ASB-1B NAV AN/ASN-6 VOR AN/ARN-14E VHF AN/ARC-1 VHF (C.F.E.) Tape Recorder AN/ALQ-41 DECM AN/ALQ-51 AN/ALQ-55 AN/APR-27 AN/ALE-29 AN/ARW-30W			IR Sensors being installed CAMERAS KA-40A KA-46A KA-47A KA-53A		

SECRET

EA-16h

Table 10 to Annex A to Appendix E

~~SECRET~~

TABLE 11

MISSION AND DESCRIPTION								
<p>The RF-4B is a two-place, twin-jet, carrier based tactical reconnaissance aircraft. The primary mission of this aircraft is all-weather, high-low, day-night selective reconnaissance operations for both prebriefed and post-strike mission. For extended range missions, both centerline and external wing tanks can be carried. The airplane can be refueled in flight.</p> <p>Optical sensors, including framing and panoramic cameras, are located in three camera stations in the nose of the aircraft. Electronic sensors include forward looking radar, side looking radar, and an infrared, reconnaissance set. Associated reconnaissance capabilities include in-flight processing of film, photoflash ejection for night Photoflash, ejection of the low altitude film cassettes, a photographic control set and HF communications set for extended communications range.</p> <p>The RF-4B features high-lift flaps with boundary layer control and automatically controlled compression-ramp air inlets. Electronic gear includes the CNI installation, the Central Air Data Computer, the Navigational Computer, the AFCS and the Electronic Altimeter.</p>								
OPERATING DATA		AVAILABILITY/DEVELOPMENT						
Vmax.....1296 KN Climb (C).....55,500 ft. No. on CVA/MCW.....0/9 Ferry range.....1740 N.M.		Letter Contract..September 1963 Mock UP.....July 1963 First Flight.....Scheduled for February 1965						
		Inventory FY 67 FY 68 FY 69 FY 70 32 30 28 25						
WEIGHTS		FUEL AND OIL		DIMENSIONS				
LOADINGS	LBS	L.F.	NO.	TANKS	GALS	LOCATION	Wing	Area.....530 sq ft
Empty	28,002		6	1273		Fuselage, Bladder	Span.....38.4 ft	
Basic	29,217		2	630		Wings, Integral	MAC.....16.04 ft	
Design	37,500	8.5/6.5a/	1	600		Fuselage,Ext.,Drop	Sweepback 25% Chord)..45°	
Combat	37,994	8.4/6.4a/	2	740		Wing,Ext.,Drop	Incidence.....1°	
Max. T.O.							Dihedral(In. Panel).....0°	
(Field)	54,800						(Out. Panel).....12°	
(Cat)	54,800						Length.....62.9 ft	
Max. Land.							Height.....16.3 ft	
(Field)	38,000						Wheelbase.....23.2 ft	
(Arrest)	34,000						Tread.....18.3 ft	
a/ Supersonic								
			OIL Integral w/Engines..5.15 Gal. (Useable tank capacity per engine) Spec.....MIL-L-7808D					
ELECTRONICS				ORDNANCE				
ANI Set.....AN/ASQ-88 Communications.....AN/ARC-105 Sound Recorder.....RO-254/ASQ CADC.....32-47106a/ Navigational Computer.....AN/ASN-46 AFCS.....AN/ASA-32D IR Detecting Set.....AN/AAS-18 Backup Attitude Ref. Set.....53-87555a/ Inertial Navigation Set.....AN/ASN-56 Radar Mapping Set.....AN/ARQ-102 Radar Set.....AN/ARQ-99 Electronic Altimeter Set.....AN/APN-159 Auxiliary Data Annotation Set (MCD).....32-87805a/ Data Recording Camera Set.....KS-74A Aircraft Camera Mount Set.....LS-58A Aircraft Camera Parameter Control.....LA-311A Photoflash Camera Control Detector.....LA-285A Radar and Homing Warning.....APR-30 Chaff Dispenser.....ALE-29 ECM Pds.....ALQ-81, ALQ-88 Beacon.....APN-154 Warning Receiver.....APR-27				CAMERAS KA-55 KA-56 KA-7L				
a/ SCD No.; "AN" No. not yet assigned								

~~SECRET~~

~~SECRET~~

TABLE 12

MISSION AND DESCRIPTION					
<p>The RF-8A/G is a photographic reconnaissance airplane. It is designed to fly general day reconnaissance missions, special missions for beach and amphibious mapping and charting, and night reconnaissance.</p> <p>The RF-8 is similar to the F-8 fighter version except for (1) front fuselage "coking" and flats to facilitate the photographic and inflight refueling (IFR) equipment, (2) the strike camera fairing on the bottom centerline of the fuselage and (3) removal of the gun humps, the RF-8 is a single-place swept-wing airplane having a high variable incidence wing and a low unit horizontal tail.</p>					
OPERATING DATA			AVAILABILITY/DEVELOPMENT		
Vmax Ceiling (C) No. on CVA-41/27/MCW 4/0 ^{a/} Ferry range 1490 N.M.			First Flight January 1957 Service Use November 1957		
^{a/} Replaced by RF-4B in FY 68			Inventory FY 67 FY 68 FY 69 FY 70 56 40 25 17		
WEIGHTS		FUEL AND OIL		DIMENSIONS	
<u>LOADINGS</u>	<u>LBS.</u>	<u>L.F.</u>	<u>GALS.</u>	<u>NO. TANKS</u>	<u>LOCATION</u>
Empty	16,795		637	3	Main Fuselage
Basic	17,564		285	5	Aft Fuselage
Design	24,000	6.4	575	1	Wing
Combat	23,752		Fuel Grade J P-5		
Max T.O.(Field)	27,822		Fuel Spec (appl) MIL-F-5624		
(Cat)	27,822				
Max Land(Field)	23,500				
(Arrest)	20,000				
			Wing Area 375 sq. ft. Span 35' 8" MAC 141 Sweepback & chord 42° Length 54' 6" Height 15' 9" Tread 9' 8"		
ELECTRONICS			ORDNANCE		
VHF Navigation Receiver Installation AN/ARN-21 UHF Transmitter Receiver AN/ARC-27A UHF Direction Finder AN/ARA-25 IFF Transponder AN/APX-6B Coder AN/APA-89 Radar Altimeter AN/APN-22 Navigation Computer AN/ASN-41 Doppler Radar Navigation AN/APN-153 TAS Computer CP-826/A ECM AN/ALQ-51 Special Warning Receiver AN/APR-27 Chaff Dispenser AN/ALE-29 Radar Hosing and Warning AN/APR-29					

~~SECRET~~

EA-16j

Table 12 to
Annex A to
Appendix E

TABLE 13

MISSION AND DESCRIPTION																											
<p>The primary mission of the RA-5C airplane is tactical reconnaissance of hostile areas from sea level or high altitudes by day or night regardless of weather or enemy defenses. Capabilities include photographic missions, attack/photographic missions, and electronic countermeasure missions. Alternate capabilities of the RA-5C include the destruction of hostile land or sea targets from sea level or high altitudes by day or night.</p> <p>The RA-5C is an improved version of the A-5A twin-engine, carrier-based, two-place attack bomber with increased radius of action and multi-sensor reconnaissance capabilities. Other features of this airplane, similar to the A-5A are: swept-back wing (with droopable leading edges and spoiler-slot-deflector lateral controls), all moveable horizontal and vertical tails, irreversible hydraulic power with artificial feel for all controls, and a linear bomb bay with rearward weapon ejection to insure weapon separation at all possible speeds, reverse attitudes and altitudes.</p>																											
OPERATING DATA			AVAILABILITY/DEVELOPMENT																								
Vmax.....1147 KN Ceiling (C).....47,300 No. on CVA-59.....6 Ferry range.....2670 NM			First Flight Prototype #3.....June 1962 First Fleet Delivery Date.....October 1963 Inventory FY 67 FY 68 FY 69 FY 70 64 65 56 69																								
WEIGHTS		FUEL AND OIL		DIMENSIONS																							
LOADINGS	LBS	L.F.	NO. TANKS	GALS	LOCATION																						
Empty	37,850		2	1430	Wing																						
Basic	38,570		4	1285	Fuselage																						
Design	49,329	4.35nz	3	885	Armament Tunnel																						
Combat	55,617	3.85nz																									
Max. T.O. (Field)	80,000	2.00nz	OIL																								
(Cat)	80,000	-5.27nz	Capacity.....	5.30 (gals.)																							
Max. Land. (Field)	58,000	1.95nz	Grade.....	C																							
(Arrest)	50,000	3.7nz	Spec. (Appl.).....	MIL-I-7808																							
Wing Area.....753.7 sq. ft.			Span.....53' - 0"																								
MAC.....18' - 9"			Sweepback.....37.5°																								
Length.....76' - 6"			Height.....19' - 4"																								
Tread.....11' - 7.5"																											
ELECTRONICS			ORDNANCE																								
AN/ASB-12 Inertial Bomb Nav Mapping Radar TV System Inertial Navigator Analog-Digital Computer AN/ASQ-56A-CNI Communications, Navigation and Identification System Autopilot Supporting Systems Air Data Computer Augmented Flight Control System AN/APN-120(XN-2) Radar Altimeter AN/ASN-54 (APC) AN/ASN-26 Master Flight Reference System ICS - Intercommunications System AC Electrical Power System DECM - Electronic Countermeasures AN/ALQ-41, AN/ALQ-51 DECM System AN/APR-18 Passive Warning System AN/APR-27 Engine Inlet Duct Control System ECM System.....AN/APD-61 IR - Programmed for 1968 Radar (SLR).....AN/APD-7 Cameras Station 1 KA-51, 6" 2 KA-50A, 1 3/4"; KA-51A, 6"; KA-62 3 PECH 4-1 KA-51A, 6"; KA-57A, 3" PAN 4-2 KA-57A, 3" PAN; KA-58A 18" PAN 4-3 KA-51A, 6"(2); KA-53A, 12"(2)			EXTERNAL ARMAMENT <table border="1"> <thead> <tr> <th>NO.</th> <th>LBS</th> <th>DESCRIPTION</th> </tr> </thead> <tbody> <tr> <td>2</td> <td></td> <td>Mk-57</td> </tr> <tr> <td>2</td> <td></td> <td>Mk-28 Special Weapon</td> </tr> <tr> <td>2</td> <td></td> <td>Mk-43 Special Weapon</td> </tr> <tr> <td>4</td> <td>1000</td> <td>Mk-83 G.P.</td> </tr> <tr> <td>4</td> <td>2000</td> <td>Mk-84 G.P.</td> </tr> </tbody> </table> TRAINING <table border="1"> <thead> <tr> <th>NO.</th> <th>DESCRIPTION</th> </tr> </thead> <tbody> <tr> <td>4</td> <td>Practice Bomb Container Aero 8A-1A</td> </tr> </tbody> </table> 1/ Carries (16) Mk-76s or Mk-89s or Mk-106s			NO.	LBS	DESCRIPTION	2		Mk-57	2		Mk-28 Special Weapon	2		Mk-43 Special Weapon	4	1000	Mk-83 G.P.	4	2000	Mk-84 G.P.	NO.	DESCRIPTION	4	Practice Bomb Container Aero 8A-1A
NO.	LBS	DESCRIPTION																									
2		Mk-57																									
2		Mk-28 Special Weapon																									
2		Mk-43 Special Weapon																									
4	1000	Mk-83 G.P.																									
4	2000	Mk-84 G.P.																									
NO.	DESCRIPTION																										
4	Practice Bomb Container Aero 8A-1A																										

~~SECRET~~

TABLE 14

MISSION AND DESCRIPTION					
<p>The Grumman E-1B is an all-weather carrier-based AEW/AIC aircraft equipped to detect and report distant airborne targets and vector interceptors into attack positions. It is designed to carry a four-man crew: pilot, co-pilot and tactical director, and two radar operators.</p> <p>The E-1B is a propeller-driven twin-engine, high-wing monoplane designed for operation from CVA-34 and superior class carriers. It is equipped for catapult and arrested landing operations, and carries a 20-ft. diameter top-mounted radome. It contains a specialized complement of electronic equipment (including radar relay, ECM, and height finding). It is equipped with slotted type flaps outboard and split inboard. Normal controls are augmented by circular arc spoilers for additional lateral control, and by rudder boost for directional control in the event of engine failure at low flight speeds.</p>					
OPERATING DATA			AVAILABILITY/DEVELOPMENT		
Vmax.....197 @ 4000' Cruising.....15,800 No. on CVA/CVS.....3 or 4 Ferry range.....900 Time on Sta.....(150 mi.) 2.3			First Flight.....17 December 1956 Service Use.....June 1959 Inventory FY 67 FY 68 FY 69 FY 70 65 52		
WEIGHTS		FUEL AND OIL		DIMENSIONS	
LOADINGS	LBS	L.F.	NO. TANKS	GALS	LOCATION
Empty	20,638		2	753	Wing
Basic	20,892				
Design	24,800	3			
Combat	24,800				
Max. T.O. (Field)	27,400				
(Cat)	27,400				
Max. Land. (Field)	24,700				
(Arrest)	24,700				
			OIL		
			Capacity (Gals.)...32		
			Grade.....1100		
			Spec. (Appl.).....MEL -L-6082		
					Wing Area.....506 sq. ft.
					Span.....72 ft. 4 in.
					MAC.....7 ft. 3 in.
					Length.....45 ft. 4 in.
					Height.....16 ft. 10 in.
					Tread.....18 ft. 6 in.
					Prop Grd Clear...11 in.
					Radome (Top-Mounted)(Dia)...20 ft.
ELECTRONICS			ORDNANCE		
UHF.....AN/ARC-52 (2) HF.....AN/ARC-38A Interphone.....AN/AIC-14 UHF Dir. Finder Group.....AN/ARA-25 Marker Beacon Receiver.....AN/ARN-12 Radar Set (Altimeter).....AN/APN-22 Radar Ident Set (IFF).....AN/APX-6B Radar Recognition Set.....AN/APX-7 Coded Group.....AN/AP1-89 Radio Set (TACAN).....AN/ARN-21 LF ADF.....AN/ARD-13 Radar System.....AN/APS-82 Radar Indicators.....IP-414/APA-125 Radar Relay Transmitter.....AN/ART-28 Navigational Computer Set.....AN/ASN-28 UHF Relay.....AN/ARC-97 (2) Navigational Computer Group.....AN/ASA-24 Compass System.....MA-1 Passive ECM Receivers			NONE		

~~SECRET~~

~~SECRET~~

TABLE 15

MISSION AND DESCRIPTION		
<p>The Grumman E-2A Hawkeye is an all-weather, carrier-based AEW/CIC airplane that patrols task force defense perimeters to provide early warning of approaching enemy aircraft and to vector interceptors into attack position. In addition to this primary AEW function, the Hawkeye can also provide strike and traffic control, area surveillance, search and rescue guidance, navigational assistance, and communications relay.</p> <p>The Hawkeye is designed for a crew of five: pilot, co-pilot, radar operator, air-control operator, and combat information center operator. The specialized complement of electronic equipment makes it feasible for three operators to search, identify, and track targets as well as control interceptions. AEW/CIC digital information can be relayed automatically, and an additional UHF communications automatic relay system relieves the crew of "middleman" duty.</p>		
OPERATING DATA		AVAILABILITY/DEVELOPMENT
Vmax.....301 Kts. @ 12,400' No. per CVA.....4 Ferry range.....1329 Time on Sta. (200 mi.).....4.3		First Flight.....October 1960 Service Use.....March 1964 Inventory FY 67 FY 68 37 45
WEIGHTS	FUEL AND OIL	DIMENSIONS
LOADINGS Empty LBS L.F. Design 41,996 3 Basic 36,208 Combat (60% fuel) 44,785 Max. T.O. (Cat) 49,638 Land. (40% fuel) (Arrest) 42,358	No. Tanks.....(2) Integral Location.....C.S. Wing Total Capacity....1784 gals. (usable) Fuel Grade.....JP-4 or JP-5 Spec. (appl.)....MIL-J-5624 OIL Capacity.....6.2 gals./ engine (usable) Spec. (appl.)....MIL-L-7808	Area.....700 sq ft Span.....80 ft 7 in Span Folded....29 ft 4 in MGC.....112.64 in Length.....56 ft 4 in Height.....18 ft 3.75 in (Rotodome raised) Height.....16 ft 5.5 in (Rotodome retracted) Tread.....19 ft 5.8 in Prop Grd Clear.(3 pt att)28 in Radome (diameter)..24 ft
ELECTRONICS		ORDNANCE
TACTICAL Rotodome.....AN/APA-143 Search Radar Set.....AN/APS-96 IFF Interrogator.....RT-26.B/APX-7 Computer Detector.....CP-413/ASA-27 Computer Indicator Group.....AN/ASA-27 Data Transmission System.....AN/ASW-14A Multi-Purpose Communication Sys.....AN/ASQ-52 Inflight Performance Monitor.....AN/ASM-33A COMMUNICATION UHF Communication System.....AN/ARC-52 HF Communication System.....AN/ARC-94 Intercommunication Set.....AN/AIC-14 Integrated Elec Control CNI Package.....AN/ASQ-58 NAVIGATION Inertial Navigation System.....AN/ASN-36 Air Data Computer.....A/A24G-13 Doppler Navigation Radar Set.....AN/APN-153v Compass System.....MA-1 LF Automatic Direction Finder.....AN/ARD-13 FLIGHT CONTROL & INSTRUMENTS AFCS.....AN/ASW-15 Radar Altimeter.....AN/APN-22		NONE.

~~SECRET~~

EA-16m

Table 15 to
Annex A to
Appendix E

TABLE 16

MISSION AND DESCRIPTION					
<p>The EA-1F is a dual purpose airplane, capable of two distinct missions; one, that of radar reconnaissance airplane, detecting enemy radar installations and, secondly, that of a radar countermeasures airplane that jams enemy radar during an attack mission by a group of bombers.</p> <p>The EA-1F is a kit-modification to the A-1F airplane. Crew consists of four: a pilot and navigator in the cockpit and two ECM operators in a rear compartment. The airplane is designed to operate from all classes of aircraft carriers or land bases.</p> <p>The airplane is conventional in design and structure incorporating a single reciprocating engine, folding wings, conventional landing gear and catapult and arrested landing equipment. Provisions are incorporated for the carrying of fuel tanks and various stores required for the missions on the bomb racks, and for installation of 4-20mm guns in the inner wings.</p>					
OPERATING DATA			AVAILABILITY/DEVELOPMENT		
Vmax S.L.....268 kts. No. per CVA.....4 Ferry range.....1800 N.M. Time on Sta. (150 mi.).....7.0 hrs.			First Flight.....October 1956 Service Use.....July 1957		
5/ 5000'			Inventory FY 67 FY 68 FY 69 FY 70 33 29 28 14		
WEIGHTS		FUEL AND OIL		DIMENSIONS	
LOADINGS	LBS	M.F.	NO. TANKS	GALS	LOCATION
Empty	12,097		1	380	Fuselage
Basic	15,932		1	150 or	Ctr. Drop
Design	17,000	6.4		300	
Combat	19,395	5.6	2	150 or	Wing Drop
Max. T.O. (Field)	25,000			300	
(Cat)	25,000				
Max. Land. (Field)	21,000				
(Arrest)	17,500				
All weights are calculated			OIL		
			Capacity.....	39 Gals.	
			Grade.....	1120	
			Spec.....	AN-O-8	
Wing Area.....400.3 sq. ft.			Span.....50 ft.		
MAC.....8.4 ft.			Length.....40.0 ft.		
Height.....15.8 ft.			Tread.....13.9 ft.		
Prop Grd Clear...6 in.					
ELECTRONICS			ORDNANCE		
UHF Trans.-Rec.....AN/ARC-27A(2) MHF Trans.-Rec.....AN/ARC-2 Radio Altimeter.....AN/APM-22 Marker Beacon.....AN/ARN-12 IFF.....AN/APX-6 IFF Coder.....AN/APA-89 I.F. ADF.....AN/ARN-6 UHF ADF.....AN/ARA-25 Radar Search.....AN/APS-31C LAB Radar Bombsight.....AN/APA-16 LAB R-R Adapter.....MX-476/APA-16 ECM Rec.....AN/AVQ-2A ECM DF.....AN/APA-69A ECM Rec.....AN/APR-13			Does not normally carry ordnance. Provisions for a total of 12 Aero 14 bomb racks on outer wings and 4-20mm wing guns with 200 rounds of ammunition each.		
PROVISIONS VHF Trans.-Rec.....AN/ARC-1 Bomb Director.....MK-3 MOD-5 ECM.....AN/ALA-3 (2) ECM.....AN/ALR-3 (2) ECM.....AN/ALT-2 (Ext; (2) CNAFF.....MX-900(1)/A (Ext) ECM.....AN/ALT-7 AN/ALT-6B AN/APA-69 AN/TLA-2 AN/ALT-2					

TABLE 17

MISSION AND DESCRIPTION						
<p>The principal mission of the EA-3B airplane is effective search for enemy radar. It can operate from land bases and from carriers.</p> <p>The airplane is conventional with two turbo-jet engines in under-wing nacelles. Provisions are incorporated for a crew of seven: a pilot, a navigator-assistant pilot, a gunner-radioman, four ECM operators including an evaluator.</p> <p>The tricycle landing gear, arresting gear, wing-fold and tail-fold mechanisms, single-slotted wing flaps, fuselage speed brakes, and power mechanisms for rudder, elevator and ailerons are operated by hydraulic power. The horizontal stabilizer is electrically adjustable for trim in-flight. Leading edge slats are actuated automatically by aerodynamic loads.</p>						
OPERATING DATA				AVAILABILITY/DEVELOPMENT		
Vmax S.L. 557 kts. Ceiling (S) 37,000 No. on CVA Ferry range 2380 Mi. Time on Sta. (100 mi.) 4.58				First Flight 12-10-58 First Flight Delivery November 59		
ag/ 5000'				Contract: NOa(s) 55-205 Five airplanes NOa(s) 57-181 Eight airplanes NOa(s) 57-181 Amendment #2 14 May 1958 Twelve airplanes (cambered leading edge wing)		
Inventory				FY 67 FY 68 FY 69 FY 70 18 18 18 18		
WEIGHTS			FUEL AND OIL			DIMENSIONS
LOADINGS	LBS	L.F.	NO. TANKS	GALES	LOCATION	Wing Area 779 sq. ft.
Empty			2	3114	Fuselage	Span 72.5 ft.
Basic	42,347		2	1298	Wing	MAC 140.14 in.
Design	55,942	3.40				Sweepback 36°
Combat	61,593	3.09				Length 76.4 ft.
Max. T.O. (Land)	78,000	2.44	NO. TANKS	OIL GALS	LOCATION	Height 23.4 ft.
(Cat)	73,000	2.60	2	11	Integral w/eng.	Tread 10.4 ft.
Max. Land (Land)	56,000					
(Carrier)	50,000		Spec.....	MIL-L-7808		
ELECTRONICS				ORDNANCE		
UHF Xmr-Rec..... AN/ARC-27A IFF..... AN/APX-68 AN/APA-89 Radar Altimeter..... AN/APN-22 TACAN..... AN/ARN-21 Radio Compass..... AN/ARN-6 Search Radar..... AN/ASB-1B Video Omni-Range..... AN/ARN-14E VHF Xmr-Rec..... AN/ARC-1 Pulse Analyzer..... AN/ALA-3 Countermeas. Rec..... AN/ALR-8 Radar Rec..... AN/ALR-3 Direction Finder..... AN/APA-69A Signal Analyzer..... AN/APA-74 Radar Rec..... AN/APR-9B Radar Rec..... AN/APR-13 Range Rec..... AN/ARC-5 HF Xmr-Rec..... AN/ARC-18 Radio Rec..... AN/ARR-40 Radio Direction Finder..... AN/ARA-25 I.C.S. - Transistorized I.C.S. (DAC) By Retrofit: Radar Set..... AN/APX-17S Comm. Set..... AN/ALR-14 DECM..... AN/ALQ-35/41/51 ECM..... AN/ALQ-55				NONE		

TABLE 18

MISSION AND DESCRIPTION					
<p>The EA-6A is a two-place tactical electronic counter measures version of the A-6A intruder all-weather, low-altitude, attack aircraft. Its primary mission is to support strike aircraft and ground troops by suppressing enemy electronic activity and to obtain tactical electronic intelligence within the combat area utilizing detecting, locating, classifying, recording and jamming techniques.</p> <p>The EA-6A has limited all-weather attack capability with conventional and special weapons.</p> <p>High lift devices are slotted flaps, and leading edge slats. Anti-skid brakes on main wheels are provided. Nose wheel tow catapulting is used. A speed brake is located aft on each side of the fuselage. Side by side ground level ejection seats are provided for the pilot and ECM operator.</p>					
OPERATING DATA		AVAILABILITY/DEVELOPMENT			
Vmax S.L. 450 kts. Ceiling (S) 38,000 ft. No. on CVA/MCW 0/9 Ferry range 2200 N.M. Time on Sta. (150 mi.) 4.0 hr.		Inventory FY 67 FY 68 FY 69 FY 70 9 8			
WEIGHTS		FUEL AND OIL		DIMENSIONS	
LOADINGS Empty 29,000 Basic 48,058 Design 40,950 5.0 Combat 41,715 Max. T.O. (Field) 54,571 (Cat) 54,571 Max. Land. (Field) 36,061 (Arrest) 36,061 All weights are estimated		NO. TANKS 3 1309 8900 Fuselage 5 1023 6857 Wings 5 1482 10,075 Drop Tanks (300gal)		Wing Area 528.9 sq. ft. Span 53 ft. MAC 130.8 in. Sweepback (1/4 chord) 25° Length 55 ft. 5.8 in. Height 15 ft. 5.9 in. Tread 10 ft. 10.5 in.	
		OIL Capacity 5 gals./eng. 10 gals. Spec (Appl) MIL-L-7808			
ELECTRONICS			ORDNANCE		
ELECTRONIC COUNTER MEASURES Warning Receiver AN/ALR-15 (4) Detection System AN/ALQ-53 Chaff Dispenser AN/ALE-18 (2) Chaff Dispenser Pod AN/ALE-32 Repeater Jammer AN/ALQ-41 Repeater Jammer AN/ALQ-51 (2) Comm Jammer AN/ALQ-55 Jamming Pod AN/ALQ-31/76 Recorder - Reproducer AN/UWH-6 (2)			Maximum Bomb Capacity: 18,000 lbs. Bombs: Mk 81, Mk 82, Mk 83, Mk 84, Fire Bomb Mk 79 Mod-1 Rocket Package: LAU-32A/A, LAU-34B/A, LAU-3A/A, ALU-10A Aero-6A, Aero-70		
ATTACK NAVIGATION INSTRUMENTS Compass System MF-1 Navigation Computer AN/ASN-66 Vertical Ref. System AN/AJA-8 Search Radar AN/APQ-103 Doppler Radar AN/APN-153 Radar Altimeter AN/APN-141 AFCS AN/ASN-16 Air Data Computer CP-817 Integrated Display Subsystem AVA-1			In addition, the following may be carried: ECM Pods: AN/ALQ-31, AN/ALT-2 Pod, Practice Bomb Containers, A/A 378-3 PNRB w/Mk 76 and Mk 89		
COMMUNICATIONS CNI Package AN/ASQ-57 UHF ADF AN/ARA-50 UHF Rec./Trans AN/ARC-52 UHF Stand-By Rec AN/ARR-40 IFF AN/APX-6B IFF Coder AN/APA-89(GIF) TACAN AN/ARN-21A ICS AN/AIC-14 Data Link AN/ASW-21					

TABLE 19.

MISSION AND DESCRIPTION						
<p>The EC-121 is a land based special search and airborne early warning airplane. As a combat information center, the EC-121 provides an airborne platform for the direction of tactical aircraft.</p> <p>The configuration features Fowler flaps, control surface boosters, rubber de-icing boots and a fully pressurized fuselage.</p> <p>The EC-121 airframe is a military adaption of the commercial Lockheed model 1049 Super Constellation. It carries a crew of 28.</p>						
OPERATING DATA			AVAILABILITY/DEVELOPMENT			
			First Flight.....June 1953 Service Use.....April 1955			
WEIGHTS		FUEL AND OIL		DIMENSIONS		
LOADINGS	LBS	cu ft.	NO. TANKS	GALS	LOCATION	
Empty	83,671		7	6550	Wing	
Basic	86,423		2	1200	Tip Tanks	
Design	130,000	2.50	1	1000	Fuselage	
Combat	116,010					
Max. T.O.	156,500	2.25				
Max. Land.	122,000					
			OIL Capacity (gals.)...30+ Grade.....120 Spec.....MIL-O-6082		Wing Area.....1650 sq. ft. Span.....123' 5" MAC.....14' -8" Sweepback(L.E.)...7.5° Length.....116' -2" Height.....27' -0" Tread.....28' -0" Prop Grd Clear...20"	
ELECTRONICS			ORDNANCE			
Search Radar.....AN/APS-20 Radar Incl Equip.....AN/APA-56 Radar Relay Trans.....AN/ART-28 Radar Relay Receiver.....AN/ARR-27A Radar Height Finder.....AN/APS-45 IFF Interrog Resp.....AN/APX-7 UHF Direction Finder.....AN/ARA-25 ECM Receiver.....AN/APR-9B ECM Panoramic Ind.....AN/ALA-2 Radar Indicator Grp.....AN/APA-81 ECM Signal Analyzer.....AN/APA-74 ECM Receiver.....AN/APR-13 Marker Beacon Receiver.....AN/ARN-12 Radar Altimeter.....AN/APN-22 Loran Receiver.....AN/APN-70 Radio Compass.....AN/ARN-6/DPA-70A Glide Slope Receiver.....AN/ARN-18 VOR Receiver.....AN/ARN-14 Navigation Set TACAN.....AN/ARN-21 IFF Transponder.....AN/APX-6(6B) HF Receiver.....AN/ARR-41 HF Transmitter Rec.....AN/ARC-119 UHF Transmitter Rec.....AN/ARC-27 Flight Crew ICS.....AN/AIC-10 Emergency Keyer.....AN/ARA-26 VHF Transmitter Rec.....AN/ARC-1 Coder Group.....AN/APA-89 Doppler Nav.....AN/APN-153						

TABLE 20

MISSION AND DESCRIPTION								
<p>The EF-10H is a two place twin engine, straight wing all-weather electronic warfare aircraft. It has the capability of conducting both active and passive electronic counter-measures.</p> <p>Side by side accommodations are provided for the pilot and a radar operator. The airplane is conventional in structure with all-metal two-spar wing and semi-monocoque fuselage. Tricycle landing gear, slotted flaps and wing folding are hydraulically operated. Hydraulically operated fuselage speed-retarding brakes with hand controls are provided. There are provisions for maneuvering or to increase the angle of descent. Pilot escape provisions are furnished both through the power operated escape hatch and through a special high speed bail-out chute on the bottom of the fuselage.</p>								
OPERATING DATA		AVAILABILITY/DEVELOPMENT						
<p>Max. 350 kts. @ 10,000 ft. Combat Radius..... 350 nm/1 hr. TOS</p>								
WEIGHTS		FUEL AND OIL		DIMENSIONS				
<p><u>LOADINGS</u> Empty 17,200 Max. T.O. 28,350 Max. Fuel 11,650</p>	<p><u>LBS</u></p>	<p><u>NO.</u> <u>TANKS</u> 1(Seal) 650 1(Seal) 290 1(Seal) 410 2 300</p>	<p><u>GALS</u></p>	<p><u>LOCATION</u> Fuse., Fwd. Fuse., Ctr. Fuse., Aft. Wing, Drop</p>	<p><u>Wing</u> Area..... 400 sq. ft. Span..... 59' - 0" Folded Span..... 26' - 10" Length..... 45' - 5" Height..... 16' - 1" Height..... 16' - 6" Tread..... 10' - 6" MAC..... 8' - 4"</p>			
		<p><u>OIL</u> Capacity (Gals.)... 4.0 Grade..... 1010 Spec..... MIL-D-6081</p>						
ELECTRONICS			ORDNANCE					
<p>Comm & ICS..... Navigation..... IFF..... Radar..... TALAAM..... ECM..... Misc.....</p>	<p>AN/ARC-27 (2) AN/AIC-4A AN/APN-1 AN/ARA-25 AN/ARN-6 AN/APX-6 AN/APA-39 AN/ARN-21 AN/ALA-3 AN/ALQ-2 AN/ALH-3 AN/ALR-8 AN/ALT-2 (2) AN/ALT-6 AN/APA-69C AN/INR-6</p>			<p><u>NO.</u> 4</p>	<p><u>SIZE</u> 20 mm</p>	<p><u>LOCATION</u> Nose</p>	<p><u>GUNS</u> Mk. 20 Mod. 0 Gunsight</p>	<p><u>RDS.</u> 800</p>

TABLE 21

MISSION AND DESCRIPTION					
<p>The principle mission of the EKA-3B airplane is to provide attack aircraft with tanking and electronic warfare support near the target area.</p> <p>The airplane is conventional with two turbo-jet engines in under wing nacelles. Provisions are incorporated for a crew of three: a pilot, navigator-EWO, and ECM operator.</p> <p>The tricyclic landing gear, arresting gear, wings-fold and tail-fold mechanisms, single-slotted wing flaps, fuselage speed brakes, and power mechanisms for rudder, elevator and ailerons are operated by hydraulic power. The horizontal stabilizer is electrically adjustable for trim in-flight. Leading edge slats are actuated automatically by aerodynamic loads.</p>					
OPERATING DATA			AVAILABILITY/DEVELOPMENT		
Vmax S.L. 557 kts. Ceiling (S) 37,000 No. on CVA 2(planned) Ferry range 2380 mi. Time on Sta.(350 mil) 2.5			Contract NOa(s) Eighteen airplanes (cambered leading edge) First Flight; Jan 67 First Flight Delivery: June 67		
Aircraft production 2/mo starting in June 1967			Inventory FY 67 FY 68 FY 69 FY 70 2 18 18 18		
WEIGHTS		FUEL AND OIL		DIMENSIONS	
Loading LBS L.F. Empty Basic 43,500 Design 57,100 Combat Max T.O. (Land) 78,000 (Cat) 73,000 Max Land (Land) 56,000 (Carrier) 50,000	GAL No. TANKS LOCATION 3087 2 FUSELAGE 1298 2 Wing 1200 1 Bomb Bay OIL GAL No. TANKS LOCATION 11 2 Integral Oil Spec. MIL-L-7808 with eng.	Wing Area 779 Sq Ft Span 72.5 Ft MAC Sweepback. 36° Length 76.4 Ft Height 23.4 Ft Tread 10.4 Ft			
ELECTRONICS			ORDNANCE		
UHF Xmt-Res AN/ARC-27A Iff. AN/APX-68, AN/APX-89 Radar Altimeter. AN/APN-22 TACAN. AN/ARN-21 Radio Compass. AN/ARN-6 Video Omni-Range AN/ARN-14E VHF Xmt-Rec. AN/ARN-1 HF Xmt-Rec. AN/ARC-38B Panoramic-Receiver(D/F). AN/ALR-28 Chaff Dispenser. AN/ALE-2 Control Receiver AN/ALR-30 Control Receiver AN/ALR-29 Radar Warning Rec. AN/ALA-32 Signal Analyzer AN/ALA-3 Direction Finder C-7317/AL ECM ALT-27, ALQ-92 DECM ALQ-41, 51, 100 Antenna Control. DAC-723971 Navigation System. AN/ASN-66 Navigation Radar AN/APN-153(V) Radio Receiver. AN/ARR-40 Radio D/F. AN/ARA-25 I.C.S. Transistorized I.C.S. (DAC)			None. Bomb Bay Space is utilized by installation of two ALE-2 Chaff Dispensers, ECM equipment racks and a tanker package. Tanker transfer rate is 420 gal/min.		

CHARACTERISTICS FOR NAVY AIRCRAFT^{a/}
TO BE DEPLOYED TO SOUTHEAST ASIA DURING
FY 1968

a/ See Tables 22 and 23

EA- 17

Annex A to
Appendix E

TABLE 22

MISSION AND DESCRIPTION						
<p>The A-7A is a single-place, carrier-based, turbofan, light attack airplane derived from the F-4 crusader series. The airplane is designed to provide high attack utility and flexibility for close support and interdiction missions. Features to expedite maintenance and minimize turnaround are important design characteristics.</p> <p>The A-7A has fixed wing incidence and a highlight system composed of leading edge flaps and single slotted trailing edge flaps. Lateral control is provided by outboard ailerons and inward spoilers. Superior stability and control qualities over the entire aircraft speed envelope, including transonic, are feature of the A-7A.</p>						
OPERATING DATA				AVAILABILITY/DEVELOPMENT		
<p>Vmax S.L. 595 Kts. Ceiling (C) 42,500 Ft. Alt. on OVA/MCW 42/80 Ferry Range 2,452 N.M. Time on Sta (150 N.M.) 3.0 hrs. ^A/ 5.0 hrs. ^B</p>				<p>Contract March 1964 First Flight September 1965 Fleet Intro. October 1966 First Deploy November 1967</p>		
<p>A/ 12 MK 81 SE B/ 12 MK 81 SE + (4) 300 Gal. tanks</p>				<p>Inventory FY 67 FY 68 FY 69 FY 70 86 242 420 596</p>		
WEIGHTS		FUEL AND OIL			DIMENSIONS	
<p>Empty 15,497 Basic 15,982 Max Take-Off (Field) (Catapult) 38,000 Max Landing (Field) (Arrested) 25,300</p>	<p>Limit L. F. 7.0 7.0</p>	<p>No. of Tanks 6 1 Fuel Grade JP-5 Fuel Spec OIL 5.0 Gal. Oil Spec MIL-L-23699</p>	<p>Location Fuzsiage Wing Wing</p>	<p>Wing Area 375 Sq Ft Span Max. 38.73 Ft Span Folded 23.77 Ft Aspect Ratio 4 Sweep & Chord 35° MAC 130.13 in Length 46.07 Ft Height 15.98 Ft Max Tread 9.5 Ft</p>		
ELECTRONICS				ORDNANCE		
<p>Radar AN/APQ-116 Data Link ASW/25 Central Air Data Computer Automatic Pit Control Sys. ASW-26 Roll/Pitch Trim System Approach Power Compensating System Gear Gear Steering System CHL Doppler Radar AN/APN-153(V) Navigation Computer AN/ASN-41 Radar Altimeter AN/APN-141 Tacan AN/ARN-52(V) Nav Sys Rollier Map 4-Inch Remote Att Ind Sys Alt & Heading Reference AN/ASN-50 Radar Beacon (X-Band) AN/APN-154 IIRF Radio Set AN/ARC-51A IIRF ADF AN/ARA-50 IIRF Auxiliary Receiver AN/ARR-69 IFF AN/APX-64 Integrated Pit Instrumentation System ADI (4060AL)</p>				<p>Maximum Bombload 14,840 MK-81, MK-82, MK-83, MK-84, MK-79, GLADEYE, SADEYE, WETEYE, ROCKEYE 1, ROCKEYE 11, WALLEYE, BULLPUP A, BULLPUP B, SHRIKE, LAU 3A/A, LAU 10/A LAU 31/A, MK-28, MK-43, MK-57, AERO 10, Aero 18A, Aero 14b, Aero 4A-1, MK-12, CBU-1A or -2, AN/ALQ-31A, AN/ALQ-31B, AN/ALQ-81, D70% Buddy, 385 Buddy, SIDEWINDER-1A & 1C-1R, MK-76, MK-89, MK-106, MK-44, LAU-33, M-117A1, BLU-24, MK-77, SUU-25, MK-122</p>		
<p>ECM Radar Warning and Warning Sys. AIR-25/27 Countermeasure ALQ-100 (Pod) AN/ALQ-88</p>						
<p>Weapons Control Weapons Release Computer CP-741/A Electrical Fuzing AN/AW-2 Radio Command Cont Trans Sight Unit AN/ARW-77 Weapons Monitor & Control T-375 Weapons Electrical Package A/A34B/2A Weapons Release Programmer AW-1</p>						

TABLE 23

MISSION AND DESCRIPTION																																																																																			
<p>The F-4J is a two-place, twin-jet, general purpose fighter whose primary mission is the destruction of enemy aircraft. The increased capability to carry and deliver conventional and special weapons enables the aircraft to perform intermediate and long range attack missions. Basic armament is four air-to-air missiles carried semi-submerged under the fuselage plus up to four wing pylon mounted air-to-air missiles. A diverse combination of bombs can be carried on five stations beneath the wing and fuselage. Three external tanks plus a retractable probe for inflight refueling provides for extended range missions. The AWG-10 Missile Control Subsystem provides the necessary guidance and control functions in the launching of air-to-air missiles. A Multiple Weapons Subsystem and an All-Altitude Bombing Computer are used for delivery of conventional bombs and rockets.</p>																																																																																			
OPERATING DATA		AVAILABILITY/DEVELOPMENT																																																																																	
<p>Vmax 2.28 N.M. Ceiling 58,900 feet No. per CVA/MAW 24/30 Ferry range 1870 1956A/ Time on Sta (150 mi.) 1.72 hrs.B/ a/ Until flt. test complete consumption increased 5% by Spec. b/ 1/4 SP III/4SW/1 Tank</p>		<p>Configuration Change Auth DEC 1954 First Flight Prototype (Mod.F-48) MAR 1966 First Flight Production (Sched) MAY 1966</p> <p>Inventory FY 67 FY 68 FY 69 FY 70 46 246 322 307</p>																																																																																	
WEIGHTS		FUEL AND OIL		DIMENSIONS																																																																															
<p>Load LB Sub Sum Empty 29,745 Basic 30,113 Design 37,500 8.5 6:5 Combat 40,614 7.9 6.0 Max T.P.(Field) 56,000 (Cat) 56,000 Max Land(Field) 46,000 14 P/Sec (Arrest) 38,000</p>		<p>No. Tanks Gal. Location 7 1368 Fuselage,Bladder 2 630 Wing, Integral 1 600 Fuselage,External Drop 2 740 Wing,External, Drop OIL Drop Grad JP4 or JP5 Spec MIL-F-5624B-1 Integral with Eng 5.15gal (Us'ble Tank Cap per Eng) Spec MIL-L-7808D</p>		<p>Wing Area 530 Sq Ft Span 38.4 Ft MAC 16.04 Ft Sweepback(+ chord) 45° Incidence 4° Dihedral Inner 0° Outer 41° Length 58.3 Ft Height 15.8 Ft Wheelbase 23.3 Ft Tread 17.6 Ft.</p>																																																																															
ELECTRONICS			ORDNANCE																																																																																
<p>CADC A/A24G() CNI Systems AN/ARM-86 TACAN AN/ANA-90 ADF LS-45/AIC 3500 Channel UHF Comm. IFF Transponder KY-532/ASQ ARCC AN/ASA-32() Navigational Computer AN/ASN-33() Altimeter AN/APN-141 Missile Control Sys AWG-10 Includes Radar AN/APG-59 Missile Control Grp. OA-6822 All-Altitude Bombing Sys. AN/AJB-7 Vertical Ref Set AN/ASN-70 Space Provisions for installation of Data Link AN/ASW-25() Warning Set APR-30() Warning Set APR-27() Chaff Dispenser ALE-29() DECM Set ALQ-51 or ALQ-100() ECM Set ALQ-91() IFF Interrogator APX-26()</p>			<p>Four SPARROW III Missiles on Fuselage</p> <table border="1"> <thead> <tr> <th rowspan="2"></th> <th colspan="2">Inboard</th> <th rowspan="2">Outboard</th> </tr> <tr> <th>Fusc.</th> <th>Wing</th> </tr> </thead> <tbody> <tr> <td>Air-to-Air Missiles</td> <td></td> <td></td> <td></td> </tr> <tr> <td>SPARROW III</td> <td></td> <td>2</td> <td></td> </tr> <tr> <td>SIDELINDER</td> <td></td> <td>4</td> <td></td> </tr> <tr> <td>Special Weapons</td> <td></td> <td></td> <td></td> </tr> <tr> <td>MK-28(EX)</td> <td>1</td> <td></td> <td></td> </tr> <tr> <td>MK-43</td> <td>1</td> <td></td> <td></td> </tr> <tr> <td>MK-57</td> <td>1</td> <td></td> <td></td> </tr> <tr> <td>Conventional Bombs</td> <td></td> <td></td> <td></td> </tr> <tr> <td>MK-81</td> <td>6</td> <td>6</td> <td>12</td> </tr> <tr> <td>MK-82</td> <td>6</td> <td>6</td> <td>12</td> </tr> <tr> <td>MK-83</td> <td>3</td> <td>4</td> <td>4</td> </tr> <tr> <td>Rocket Packages</td> <td></td> <td></td> <td></td> </tr> <tr> <td>Aero 7D(19-2.75" rockets per pkge)</td> <td>3</td> <td>6</td> <td>6</td> </tr> <tr> <td>LAU 10A(4-5.00" ZUNI rockets per package)</td> <td>3</td> <td>6</td> <td>6</td> </tr> <tr> <td>Practice Dispenser</td> <td></td> <td></td> <td></td> </tr> <tr> <td>Aero 8A</td> <td>1</td> <td></td> <td></td> </tr> <tr> <td>Gun Pod</td> <td></td> <td></td> <td></td> </tr> <tr> <td>MK-4 (20mm)</td> <td>1</td> <td></td> <td></td> </tr> </tbody> </table>				Inboard		Outboard	Fusc.	Wing	Air-to-Air Missiles				SPARROW III		2		SIDELINDER		4		Special Weapons				MK-28(EX)	1			MK-43	1			MK-57	1			Conventional Bombs				MK-81	6	6	12	MK-82	6	6	12	MK-83	3	4	4	Rocket Packages				Aero 7D(19-2.75" rockets per pkge)	3	6	6	LAU 10A(4-5.00" ZUNI rockets per package)	3	6	6	Practice Dispenser				Aero 8A	1			Gun Pod				MK-4 (20mm)	1		
	Inboard		Outboard																																																																																
	Fusc.	Wing																																																																																	
Air-to-Air Missiles																																																																																			
SPARROW III		2																																																																																	
SIDELINDER		4																																																																																	
Special Weapons																																																																																			
MK-28(EX)	1																																																																																		
MK-43	1																																																																																		
MK-57	1																																																																																		
Conventional Bombs																																																																																			
MK-81	6	6	12																																																																																
MK-82	6	6	12																																																																																
MK-83	3	4	4																																																																																
Rocket Packages																																																																																			
Aero 7D(19-2.75" rockets per pkge)	3	6	6																																																																																
LAU 10A(4-5.00" ZUNI rockets per package)	3	6	6																																																																																
Practice Dispenser																																																																																			
Aero 8A	1																																																																																		
Gun Pod																																																																																			
MK-4 (20mm)	1																																																																																		

CHARACTERISTICS FOR NAVY AIRCRAFT^{a/}
TO BE DEPLOYED TO SOUTHEAST ASIA AFTER
FY 1968

E-2B
EA-6B

a/ See Tables 25 through 26

EA-18

Annex A to
Appendix E

TABLE 25

MISSION AND DESCRIPTION			
<p>The Grumman E-2B HAWKEYE is an improved version of the E-2A all weather, carrier based AEW/CIC airplane. This airplane patrols task force defense perimeters to provide early warning of approaching enemy aircraft and to vector interceptors into attack position. In addition to this primary AEW function the HAWKEYE can also provide strike force control, air traffic control, surface surveillance (over water), data relay, EHCOC, ASW coordination, control of mine forces and tactical deception.</p> <p>The HAWKEYE is designed for a crew of five: pilot, co-pilot, radar operator, air-control operator, and combat information center operator.</p> <p>Operable from all angle deck CVA-19 and superior class carriers, the E-2B is catapulted with a nose, tow catapult system. Automatic wingfold and rotodome lowering permit hangar deck servicing. The E-2B also has a limited capability for operating from CVS-10 class carriers.</p> <p>The airplane may be easily identified by the rotodome of 24 feet diameter and four vertical tails. The flight controls are powered by two independent hydraulic systems.</p>			
OPERATING DATA		AVAILABILITY/DEVELOPMENT	
		First Flight (E st.) August 1968 Service Use (E st) July 1970 First Deployment June 1971	
WEIGHTS		FUEL AND OIL	DIMENSIONS
LOADING Empty 37,595 Design 45,125 Basic 38,917 Combat (40% fuel) 46,357 Max L.O. Catapult 51,517 Landing Arr (40% fuel) 41,037 Source: Contractor Estimated	Lbs. 3 L.O.	No. tanks Location C.S. Wing Total Cap 1748 Gal/stus' b1 Fuel Grade JP-4 or JP-5 Spec (appl) MIL-J-5624 OIL Capacity 6.2 Gals/eng (us/bl) Spec (appl) MIL-L-7808	Wing Area 700 Sq Ft Span 80' 7" Span Folded 29' 4" MAC 112.64" Length 56' 4" Height (Roto raised) N.A. Height (Roto Retract) N.A. Tread 19' 5.2" Prop Ground Clearance 2ft
ELECTRONICS		ORDNANCE	
TACTICAL Rotodome AN/APA-164 Search Radar Set N.A. IFF Interrogator APX-69 Radar Detection Proc. N.A. IFF Detection Proc. N.A. Computer Indicator Grp. N.A. Data Transmission Sys AN/ART-36 AN/ARP-66 ID-902/AR Multipurpose Comm. Sys AM/AWQ-99 Signal Conditioner & Readout N.A. COMMUNICATION IFF Comm. Sys AN/ARC-51A HF Comm. Sys. AN/ARC-104 Intercommunication Set. AN/AIC-14A NAVIGATION Advanced Inertial Navig Sys N.A. Air Data Computer A/A24G-13 Doppler Navig Radar Set AN/APN-153V Computer Sys AN/ASN-76 LF Auto Direction Finder AN/ARN-83 FLIGHT CONTROL & INSTRUMENTS APCC AN/ASW-15 Radar AN-APN-171		None	

TABLE 26

MISSION AND DESCRIPTION					
<p>The primary mission of the EA-6B is tactical jamming. Its purpose is to degrade the enemy's air-defense system through active jamming of his radars, thereby enhancing the effectiveness and survivability of strike aircraft. Radars to be jammed include ground-controlled-intercept, early-warning, acquisition, and track-while-scan types. To minimize the exposure of the EA-6B, jamming operations are performed as far from the objective area as is feasible and, in most cases, outside the lethal range of ground-to-air (AAA and SAM) weapons. Therefore, the Tactical Jamming Mission is accomplished by either a Stand-off Jamming Loiter Profile (short-range jamming), depending on the tactical situation.</p>					
OPERATING DATA			AVAILABILITY/DEVELOPMENT		
			First Flight (Feasibility Prototype) April 1967 Service Use January 1970 Total planned procurement 95 aircraft		
WEIGHTS		FUEL AND OIL		DIMENSIONS	
LOADINGS	LBS	L.F.	No. Tanks	Gals.	Lbs. Location
Empty	34,231		3	1295	2805 Fuselage
Design	51,000	5.5	5	1018	6923 Wings
Max T.O. (Field)	65,000		5(300gal)	1482	10,075 Drop Tanks
(Cat)	65,000				Fuel Grade JP-5
Max Landing (Field)	45,500				Fuel Spec (appl) MIL-F-5624C-1
(Arrested)	45,500				OIL
			Capacity	5 gal/eng	10 gal
			Spec (appl)	MIL-L7808	
Wing Area			.528.9 Sq ft		
Span			.53 ft		
MAC			.130.8 in		
Sweep (± chord)			.25°		
Length			.59' 4.5"		
Height			.15' 3"		
Tread			.10' 10"		
ELECTRONICS			ORDNANCE		
COMMNAVIDENTSYSTEM Radar AN/APQ-103 Doppler AN/APN-153 Altitude AN/ASN-50 Electronic Central AN/ASQ-57 Intercom AN/AIC-14A Defensive Electronic Counter Measures (DECM) Jammer AN/ALQ-41 Jammer AN/ALQ-100 Chaff Dispenser AN/ALE-29 System Integration Rec. Jammer AN/ALQ-55(Mod) Flight Control APCS AN/ASW-16 Electronic Weapons Systems Tactical Jamming Sys(TJS) . . . AN/ALQ() Surveillance Receiver Jammer Pods (5) Displays Jammer Pod AN/ALQ-76			No ordnance. Aircraft carries Jamming pods (TJS) and AN/ALQ-76.		

CHARACTERISTICS FOR US AIR FORCE^{a/}
AIRCRAFT CURRENTLY IN SOUTHEAST ASIA

F-4C
F-105D/F
RF-4C
RF-101
EB-66B/C
EC-47
RC-121D
RC-135
C-130A/B
KC-135A
B-52

a/ See Tables 27 through 38

TABLE 27

MISSION AND DESCRIPTION		
F-4C		
<p>The F-4C is a two place, twin jet, all-weather air-to-air intercept fighter w/4 Sparrow and 4 Sidewinder missiles. Intercept radar has 200NM. Gun sight is fixed and cannot compute lead for externally mounted gun. Visual attack w/conventional and nuclear externally mounted stores. Navigation aids: TACAN, UHF/ADF, Inertial Navigation System and limited radar ground mapping. Air refuelable. Automatic flight control system with control stick steering. The aircraft is manned by two pilots.</p>		
OPERATING DATA		AVAILABILITY/DEVELOPMENT
Ferry Range.....1780nm Refuel.....Unlimited Cmbt Ceil.....51,800' Cmbt Wg.....42,476# Cmbt Config.....2/370s+4 Sparrows Rate of Clb.....36,750 FPM Top Speed.....2.2 Mach		Total Inventory FY 67.....457 None in production SEA Attrition Approx 90/Year DEPLOYMENT DaNang.....54 Ubon.....54 Cam Ranh Bay.....72
WEIGHTS	FUEL AND OIL	DIMENSIONS
Max. Gross.....58,000 lbs. Int Fuel Only.....46,415 lbs. Max. Land Wt.....46,000 lbs. T.O. Roll Max Wt...5100' Design limits can be exceeded for special missions.	Start Unit.....Air Cartridge JP-4.....3,112 gal. Internal.....1,889 gal.	
ELECTRONICS		ORDNANCE
RHAW.....APR 25; APR 26 Gain Time.....108 F-4C Sky Spot.....X-Band Trans. Jammer.....4RC-160A-1 Loran-D.....65 F-4C All MODs for incorporation of Improved Navigation Computer		SUU.....16 Gun POD SUU.....25 Flare Pod CBU.....24 Wild Weasel.....36 A/C for SEA AIM.....4D (Falcon) replacing AIM-9 (Sidewinder) (See external stores loading chart)

TABLE 28

MISSION AND DESCRIPTION		
F-105D/F		
<p>The principal mission is that of an all-weather fighter-bomber. R-14A Search and Ranging radar used in conjunction with the AN/APN-131 Doppler Navigator permits navigation and weapon delivery on any target regardless of route or weather. A radar terrain avoidance mode permits a pilot to let down through weather in unfamiliar territory. Air refueling capability. High angle bomb delivery includes manual, radar ranging, or pressure ranging modes.</p> <p>The F-105F, a development of the F-105D, is a two-place aircraft. It is 31 inches longer and weighs approximately 1500 lbs. more than the D. Mission capability is approximately the same, except that the F-105F is primarily used in the Wild Weasel program.</p>		
OPERATING DATA		AVAILABILITY/DEVELOPMENT
Ferry Range.....1917NM Refuel.....Unlimited Cmbt. Conf.....2x450 TKS 6M117s Cmbt. Hnd.....506NM Cmbt T.O. Wt.....50,231 lbs		No further production SEA Attrition FY 67 (EST).....174 Current Inventory.....252 DEPLOYMENT Korat-72/Takhli-54.....Current Korat-36/Takhli-54.....2/64 Korat (F only).....8 (Wild Weasel) Takhli (F only).....7
WEIGHTS	FUEL AND OIL	DIMENSIONS
Max T.O.....52,838 lbs T.O. Dis.....6,500'	Internal (W B/B tk).....1550 gal. Total w/2x450 tks.....2450 gal. Total w/2x450+1x650 tks..3100 gal.	
ELECTRONICS		ORDNANCE
HMF-DF-ILS-TACAN IFF/SIF-Doppler-Fire Control System RHAW (APR 25/26) ER-133 QRC-160A-1 QRC-272		AIM-9 AGM-12 AGM-45 (F only) MK 81 MK 82 MK 83 M-117 BLU-1B LAU-3 CBU-2 CBU-24 M-61 M-118 CBU-1 CBU-3 MLU-10/B SUU-25 Flare Pod

TABLE 29

MISSION AND DESCRIPTION		
RF-4C		
A two-place, twin engine jet reconnaissance aircraft. Provides day and night all-weather air reconnaissance. Uses visual, photographic, radar, infrared, or electronic sensory means for pre-strike targeting, post-strike assessment, and other reconnaissance necessary for accomplishment of the theater mission.		
OPERATING DATA		AVAILABILITY/DEVELOPMENT
Ferry Range.....1850NM Cmbt Ceiling.....56,000' Speed Mach.....2.21 T.O. Max.....4,000' Air Refuelable . Lo-lo-lo-434NM radius		FY-67.....216 Max FY-70 (Avail for Cmbt).....288 Production Rate (By End FY 67).....8/Month Attrition Est SEA.....32/Yr DEPLOYMENT Tan Son Nhut.....36 Udorn.....24 After Oct 67 Tan Son Nhut.....52 Udorn.....24
WEIGHTS	FUEL AND OIL	DIMENSIONS
Max.....52,424 lbs Internal.....42,734 lbs	JP-4	
ELECTRONICS		ORDNANCE
RHAW.....APR 25/26 ELRAC.....AN/ALR-17 QRC-160A-1 QRC-272		SENSORS Forward Oblique Frame Left and Right Oblique.....KS-72 Lo-Alt Panoramic.....KA-56 Hi-Alt.....KA-55 Mapping.....T-11 Illumination.....M-112A or M-123 Side-looking Radar.....AN/APQ-102 IR-AN/AAS-18

TABLE 30

MISSION AND DESCRIPTION		
RF-101		
<p>A single place, twin engine jet aircraft capable of performing long range high/low altitude day reconnaissance. Through use of visual and photographic sensory means the RF-101 is capable of providing pre-strike, post-strike and surveillance reconnaissance in support of the theater mission.</p>		
OPERATING DATA		AVAILABILITY/DEVELOPMENT
Ferry Range.....1864NM Ceiling.....51,000 ft Hi-Lo-Hi.....637NM Low.....457NM Air Refuelable		Total Inventory.....84 ANG-54 None in production SEA Attrition.....17/Yr DEPLOYMENT Tan Son Nhut.....16 Udorn.....16
WEIGHTS	FUEL AND OIL	DIMENSIONS
Empty.....25,335 lbs Cmbt.....35,751 lbs	JP-4 Total.....2,250 gal External.....900 gal	
ELECTRONICS		ORDNANCE
GPT.....AN/ASN-6 Radar Warning.....AN/APS-54 APS-54 Nav Computer.....AN/ASN-7 AN/APN-102 RHAW.....APR 25/26 ECM ALQ-51		CAMERAS Forward Oblique Frame.....FS-72 Left & Right Oblique Frame.....FS-72 Vertical Panoramic.....KA-56A Hi-Alt Split Vertical Sta.....2KA-1 Alt Cameras, Vertical Sta.....T-11 KA-18A

TABLE 31

MISSION AND DESCRIPTION		
EB-66B		
<p>The EB-66B aircraft is an electronic warfare support aircraft combining passive and active electronic countermeasures. Intercept, analyze, and D/F electronic emitters within a frequency band from 65mc to 10,750mc. Nine jamming transmitters and two chaff dispensers cover all radar frequencies presently active in NVN. Jammers are controlled by four EMOs who divide the frequency spectrum. Performs broad band barrage jamming and presently has no passive capability other than a wide open warning receiver. Twenty-three jamming systems and two chaff dispensers covering all frequencies employed by NVN.</p>		
OPERATING DATA		AVAILABILITY/DEVELOPMENT
Crew.....Pilot, Navigator, EMO		DEPLOYMENT
		Takhi.....13
WEIGHTS	FUEL AND OIL	DIMENSIONS
Empty.....42,186 lbs Design.....78,000 lbs Combat.....59,300 lbs	JP-4 5,387 gal 5,487 gal (internal)	
ELECTRONICS		ORDNANCE
ALT-15L ALT-15H ALT-16 QRC-65 ALT-13 ALT-22 AIR-18 APS-54 QRC-218 ALE-2		

TABLE 32

MISSION AND DESCRIPTION				
<p align="center">EB-66C</p> <p>The EB-66C aircraft is an electronic warfare support aircraft combining passive and active electronic countermeasures. Intercept, analyze, and D/F electronic emitters within a frequency band from 65mc to 10,750mc. Nine jamming transmitters and two chaff dispensers cover all radar frequencies presently active in NVN. Jammers are controlled by four EWOs who divide the frequency spectrum.</p> <p>Orbit is established perpendicular to the entry path of the strike aircraft to provide jamming coverage.</p>				
OPERATING DATA		AVAILABILITY/DEVELOPMENT		
		<p align="center">DEPLOYMENT</p> <p>Takhlil.....15</p>		
WEIGHTS	FUEL AND OIL	DIMENSIONS		
Max Gross.....83,000 lbs Normal Load.....53,000 lbs	JP-4 5,312 gal 902 gal (Ext)			
ELECTRONICS		ORDNANCE		
<table border="0"> <tr> <td style="vertical-align: top;"> ACTIVE QRC-114 ALT-15L/H ALR-18 APS-54 QRC-279 ALE-1 QRC-218 </td> <td style="vertical-align: top;"> PASSIVE APR-14 ALA-6 ALA-5 ANH-2 APR-9 APA-74 WTR-128/129 WAS-656 WKD-2 </td> </tr> </table>		ACTIVE QRC-114 ALT-15L/H ALR-18 APS-54 QRC-279 ALE-1 QRC-218	PASSIVE APR-14 ALA-6 ALA-5 ANH-2 APR-9 APA-74 WTR-128/129 WAS-656 WKD-2	
ACTIVE QRC-114 ALT-15L/H ALR-18 APS-54 QRC-279 ALE-1 QRC-218	PASSIVE APR-14 ALA-6 ALA-5 ANH-2 APR-9 APA-74 WTR-128/129 WAS-656 WKD-2			

TABLE 33

MISSION AND DESCRIPTION		
EC-47		
The primary purpose of the EC-47 is detection and location of low power HF transmitters operated by hostile forces.		
OPERATING DATA		AVAILABILITY/DEVELOPMENT
Cruise.....145 kts 7-hrs		47 being modified for SEA plus 6 attrition/trng aircraft No further production DEPLOYMENT SVN.....47 in place by 31 Mar Tan Son Nhut Pleiku Nha Trang
WEIGHTS	FUEL AND OIL	DIMENSIONS
Design.....26,000 lbs	100/130 802 gal	
ELECTRONICS		ORDNANCE
ARD-18 ARC-27 ARC-44 ARA-25 AIX-25 Radio Receivers: 2 each G186B 2 each G113F Tape Recorder: 0-176/184		

TABLE 34

MISSION AND DESCRIPTION		
<p style="text-align: center;">EC-121D</p> <p>Operates as an Airborne Early Warning (AEW) airplane and/or Special Search or Patrol operations.</p> <p>This aircraft is equipped with the latest electronics including search radar, height finder radar, and radar relay transmitters. This equipment enables the aircraft not only to effectively search for and locate hostile aircraft and surface vessels, but also to determine the range and altitude of hostile aircraft.</p>		
OPERATING DATA		AVAILABILITY/DEVELOPMENT
T.O. Roll (for 50 ft obstacle design weight).....5000' 200 KIAS for Approx 20 hrs		Total.....43 EC-121D Committed to North American Air Defense DEPLOYMENT SEA Ubon.....4 A/C U-Tapao.....4 A/C Nam Phong Dec 67-21
WEIGHTS	FUEL AND OIL	DIMENSIONS
Empty.....80,611 lbs Design.....130,000 lbs	115/145 Total 8,750 gal Oil Grade 1100	
ELECTRONICS		ORDNANCE
Search Radar.....AN/APS-95 Height Finder.....AN/APS-45-103 Radar Identifier.....AN/APX-25 IFF/SIF.....AN/APX-7849 Grnd Pos Ind.....AN/APX-57 Az-Rg Ind.....IP-2294-2&230 IJHF/DF.....AN/ARA-25		

TABLE 35

MISSION AND DESCRIPTION		
RC-135		
<p>The principal mission of the RC-135 is long range, high altitude, airborne communications reconnaissance and limited electronic intelligence collecting and recording ground station radio and radar emissions. The RC-135 is derived from the KC-135.</p>		
OPERATING DATA		AVAILABILITY/DEVELOPMENT
Speed.....445 kts Ceiling.....40,000 + Air-Refueling for 12 + hour missions		Total FY 67.....4 Currently Being Modified.....5 Total.....9 A/C DEPLOYMENT FY 68 Yokota AB, Japan.....6
WEIGHTS	FUEL AND OIL	DIMENSIONS
Design.....301,000 lb	JP-4 Total 29,026 gal	
ELECTRONICS		ORDNANCE
VHF/UHF Receivers.....G-1000/1034 Elec Recon.....AN/APN-17 Pen Rcvr.....G-1099 DF.....AN/ARR-6 DF.....AN/ALA-6 Recorders.....G/1001/1132,1171 AN/ALH-4 Secure Digital Comm.....AN/ARC-106		

TABLE 36

MISSION AND DESCRIPTION		
<p style="text-align: center;">C-130 A/B</p> <p>This aircraft is being modified for airborne communications reconnaissance and limited electronic intelligence collection.</p>		
OPERATING DATA		AVAILABILITY/DEVELOPMENT
Crew.....2 Operating Positions.....10 Ceiling.....35,000' Cruise.....285 kts		A/C Modified for this Mission.....18 <p style="text-align: center;">DEPLOYMENT</p> FY 68 Da Nang.....6
WEIGHTS	FUEL AND OIL	DIMENSIONS
Design.....135,000 lbs	JP-4 6960 lbs	
ELECTRONICS		ORDNANCE
VHF/UHF Receivers.....G-100/1034 HF Receiver System.....G-1013 Panoramic Receiving System.....G-1099 Direction Finder.....G-1003 Recording Systems.....1132 & 1171		

(5) CBU/ADU

CBU-2 Anti-Mat
CBU-12 Smoke/Incend
CBU-14 Anti-Mat
CBU-24/29 Anti-Pam
ADU-253B W/BLU-3B Cannisters
ADU-272B W/BLU-26/B Cannisters

(6) AIR-TO-GROUND MISSILES

AGM-12C (BULLPUP B)
AGM-45A (SHRIKE)
(WALLEYE)

(7) AIR-TO-AIR MISSILES

AIM-4D (FALCON)
AIM-7D/E (SPARROW)
AIM-9D (SIDEWINDER)

(8) SURFACE-TO-AIR MISSILES

RIM-2E (TERRIER)
RIM-8 (TALOS)
RIM-24 (TARTER)
(HAWK)

2. (S) Deficiencies

a. There is currently a requirement for certain munitions that have not been satisfied by present development and production efforts. Specifically, these deficiencies include the SHRIKE air-to-ground missile, the CBU-24 flak suppression munition, heavier bombs in the 2000 - 3000 pound category, and bomb fuzes of the proximity and long-delay category. SHRIKE missiles with an improved marking warhead are presently being used in Southeast Asia. However, production to satisfy CINCPAC requirements will not be realized until November 1967. The CBU-24/B loaded with BLU-26/B bomblets has been highly effective as a flak suppression weapon. The demand for the munition far exceeds the present production schedule. As a result, the CBU-24/B is severely

~~SECRET~~

ANNEX B TO APPENDIX E
MUNITIONS

1. (S) General

The current types of munitions in Southeast Asia are listed below. Those listed are preferred munitions and do not include available quantities of substitute or older items, which are no longer in production and which may be expended as operationally required.

(1) BOMBS

M1A2 100 lb Frag
MK-81 250 lb
MK-82 500 lb
M-117 750 lb
MK-83 1,000 lb (No longer in production)
MK-84 2,000 lb
M-118 3,000 lb (No longer in production)
BLU-31 750 lb Land Mine

(2) ROCKETS

2.75" Rocket Motor
5" Zuni

(3) GUN CARTRIDGES

7.62 MM (Air Force)
20 MM MK-11/12 (Navy)
20 MM M39/61 (Air Force)

(4) FIRE BOMBS

BLU 1/27 750 lb Napalm
MK 77 500 lb Fire Bomb
BLU 23/32 (No longer in production)

~~SECRET~~

EB-1

Annex E to
Appendix E

~~SECRET~~

rationed and is considered to be one of the most critical supply items. Production of the CBU-24/B increases monthly with a level-off of 8000 units per month scheduled by February 1968. Heavy bombs in the 2000 - 3000 pound category are also rationed. The M-118 (3000 lb) GP bomb is no longer in production. Current allocated expenditure of approximately 250 units per month should conserve the M-118 stock through CY 68. Production output of the M-84 (2000 lb) bomb will begin in September 1967 and will reach its planned output of 1500 units per month by December 1967. The BLU-34/B, 3000 pound demolition bomb, is scheduled for 1000 per month output with initial operational capability by September 1967.

b. The FMU-57/B low altitude proximity fuze, which will enhance the lethality of standard low-drag bombs against soft targets, is presently in development and test and is scheduled for operational use by February 1968. The FMU-56/B high altitude proximity fuze is being developed for use with the CBU-24/B. Use of this fuze will provide dispenser burst altitudes which are independent of delivery attitude, altitude, and airspeed. The FMU-35/B long-delay electronic bomb fuze has been developed for use with general purpose bombs. Firing delays ranging from 20 minutes to 36 hours can be set. Adequate quantities to satisfy CINCPAC requirements will be available in November 1967.

3. (S) Future Improvements

a. Munitions improvements scheduled to occur between now through FY 67 have been previously discussed. Of primary concern will be the monthly production increase of the SHRIKE and CBU-24/B munitions.

b. During FY 68, production will satisfy CINCPAC requirements for CBU-24/Bs by February 1968 and the MK-84 bomb by December 1967. A proximity fuze is being developed for the BLU-26/B bomblet, which will detonate the munition approximately two to eight feet above the ground. Testing is presently being conducted. Successful completion of these tests should provide a dual-bursting capability for the

~~SECRET~~

EB-3

Annex E to
Appendix E

~~SECRET~~

BLU-26/B during FY 68. The FMU-56/B, high altitude proximity fuze for the CBU-24/B dispenser, will be available during early FY 68.

c. The BLU-31 (750 lb) land mine bomb replaces the MLU-10/B. First combat employment availability will be November 1967. The FMU-30/B land mine fuze, used with the BLU-31/B, is a pressure sensitive fuze for use against trucks and tanks as well as railway engines. Production of fuzes equates to BLU-31 production.

d. The WALLEYE is an air-to-surface homing glide weapon incorporating a contrast tracking television system for guidance. Production increases each month until leveling off at 500 units per month by December 1967. Operational test and evaluation of the WALLEYE/F-4D (COMBAT EAGLE) begins in March 1967 with Southeast Asia deployment scheduled for June 1967.

e. Two missiles currently in development are the Standard ARM, an air-to-surface missile, and the Talos ARM, a surface-to-surface missile. Both are antiradiation types. Although no production has been authorized for the Standard ARM, both could be available for operational use during FY 68, if funds were provided.

f. Stimulated by the emphasis on non-nuclear munitions in the early 1960's and the added directions provided by the lessons learned during actual combat operations, the development organizations of all Services are investigating many new weapons for future combat employment. Discussed below are some of those munitions, now in development and available post FY 68, that would improve our current effectiveness against the air defense system of North Vietnam.

(1) The AIM-54A PHOENIX air-to-air missile is designed to provide an advanced capability in air defense missions and is planned for use on the F-111B. Six missiles, each weighing about 1000

~~SECRET~~

EB-4

Annex B to
Appendix E

~~SECRET~~

pounds. will be carried on the F-111B. The PHOENIX Missile System will provide an almost simultaneous launch capability against six different targets.

(2) The AGM-53A CONDOR air-to-ground missile is an advanced medium range, optically guided weapon, which utilizes a high performance, restartable propulsion system. It has a 600 pound warhead with an over-all weight of 1700 pounds. The missile employs a television seeker and data link to relay a television picture of the surface in front of the missile to the control operator in the launch aircraft. The seeker can be locked-on the target by the operator when the missile nears the target.

(3) Establishing the feasibility of weaponizing the fuel-air explosive (FAE) phenomenon is underway. One of the advantages of this munition is the total lethality to exposed or lightly sheltered personnel within or nearby to the fuel-air cloud. Compared with a bomb containing the same weight of TNT, the FAE weapon is vastly more effective against exposed personnel. Although the TNT creates higher overpressures near the point of detonation of the bomb, the overpressure of the blast decays at greater ranges with the cube of the radial distance. The greater yield of the FAE weapon results from the large area over which the explosive mixture can be distributed and from the greater energy yield per unit weight because the required oxygen is supplied by the surrounding air.

(4) A hard structure warhead is being developed capable of defeating hard targets such as heavy bridge piers, tunnels, underground control and storage facilities, and dams. Present bombs do not penetrate the target sufficiently or effectively before detonation. The hard structure munition is visualized to have an electro-optical guidance system, rocket propulsion, and a launch-and-leave capability. The warhead employs a two-stage explosion concept. The primary stage explodes on

~~SECRET~~

EB-5

Annex B to
Appendix E

impact causing damage to the target surface by cratering, scabbing, or penetration. The secondary stage penetrates or perforates the target and explodes.

(5) An aerial cratering device, deployed from a dispenser, is being developed for use against runways, roads, and other horizontally surfaced targets. The device is designed to penetrate a minimum of 12 inches of reinforced concrete and to produce a crater at least three feet in diameter beneath the penetrated surface. The type of damage caused by the aerial cratering device is more difficult to repair than the simple craters produced by munitions presently available. It is anticipated that 40 of these munitions could be carried in a SUU-13/A dispenser.

4. (S) The following section lists munitions broken down into three time frames: currently employed in Southeast Asia, available for employment in FY 68, and available for employment after FY 68. In addition, programmed schedules for certain selected munitions are shown.

a. While biological and gas munitions are applicable to this study, they have not been included in these listings since political constraints make use of these munitions highly unlikely.

b. A glossary of munitions abbreviations used herein follows:

GLOSSARY OF MUNITIONS TERMINOLOGY

<u>Abbreviation</u>	<u>Definition</u>
ADU	Adapter Unit
AGM	Air launched, Surface attack, Guided missile
AIM	Air launched, Aerial intercept, Guided missile
AIR	Air launched, Aerial intercept, Unguided rocket

~~SECRET~~

<u>Abbreviation</u>	<u>Definition</u>
AN-Preceding desig.	Army-Navy standard item (e.g., AN-M166 Fuze)
Anti-PAM	Anti-Personnel and Materiel (Former desig. for Napalm Fire Bomb)
AP	Armor Piercing
APF	Armor Piercing Fragmentation
API	Armor Piercing Incendiary
ATLM	Anti-Tank Land Mine (Redesignated AVLM)
AVLM	Anti-Vehicle Land Mine
BDU	Bomb, Dummy Unit
BLU	Bomb, Live Unit
BZ	Chemical agent, incapacitating
CBU	Cluster Bomb Unit
CL	Chemiluminescent agent
CS	Chemical agent, riot control
FAE	Fuel-Air Explosive (Navy, formerly FAX)
FAX	Fuel-Air Explosive (USAF)
FFAR	Folding Fin Aerial Rocket
FMU	Fuze, Munitions Unit
FRAG	Fragmentation (Bomb)
GAM	Guided Aircraft Missile (Obsolete)
GAR	Guided Aircraft Rocket (Obsolete)
GAU	Gun, Aircraft Unit
GB	Chemical agent, lethal
GMG	Gatling Machine Gun
GP	General Purpose (Bomb)
GPU	Gun, Podded Unit
HC	Chemical agent, smoke (Harmless Cloud)
HE	High Explosive
HEAT	High Explosive Anti-Tank (2.75" FFAR Warhead)
HEI	High Explosive Incendiary
HLT	Head Light Tracer
HVAR	High Velocity Aircraft Rocket
LAU	Launcher, Aircraft installed Unit
LC	Light Case (Bomb)
M	Army standard item (e.g., M117 GP bomb)
MAU	Miscellaneous Armament Unit
MBR	Multiple Bomb Rack

~~SECRET~~

EB-7

Annex B to
Appendix E

~~SECRET~~

Abbreviation

Definition

MER	Multiple Ejector Rack
MG	Machine Gun
MK	MARK, Navy Standard item (e.g., MK-24 Flare)
MLU	Miscellaneous Live Unit
MOD	Modification, Navy standard item (e.g., MK-24 Mod 3 Flare)
MXU	Miscellaneous Unit not otherwise covered
NAPALM	An incendiary mixture, basic to tank-type fire bombs
PWP	Plasticized White Phosphorus (Smoke-Incendiary filler)
R-Following desig.	Retarded (e.g., M117R)
RBM	Rocket Boosted Munition
RIM	Ship launched, Aerial intercept, Guided missile
RMG	Revolver Machine Gun
SAP	Semi-Armor Piercing
SUU	Suspension and Release Unit
T	Army test item (e.g., T56E5 GP Bomb)
TDU	Target Device Unit
TFD	Tactical Fighter Dispenser
TFDM	Tactical Fighter Dispenser Munitions
TER	Triple Ejection Rack
WAAPM	Wide area Anti-Personnel Mine
WDU	Warhead Unit (e.g., WDU-4/A 2.75" FFAR Flechette warhead)
WP	White Phosphorus (Smoke-incendiary filler)
X-Preceding desig.	Experimental stage (e.g., XAGM-69A)
Y-Preceding desig.	Prototype stage (e.g., YRIM-66A)
Z-Preceding desig.	Conceptual stage (e.g., ZAGM-63A)

~~SECRET~~

EB-8

Annex B to
Appendix E

~~SECRET~~

MUNITIONS CURRENTLY AVAILABLE FOR SOUTHEAST ASIA

EXPLOSIVE BOMBS a/

AN-M57A1 250# GP
MK 81 250# GPLD
MK 81RA 250# GPHD
AN-M64A1 500# GP
MK 82 500# GPLD
MK 82R 500# GPHD
M117 750# GPLD
AN-M65A1 1000# GP
MK 83 1000# GPLD
AN-M59A1 1000# SAP
MK 84 2000# GPLD
M118 3000# GPLD

FIRE BOMBS b/

BLU-10/B 250#
BLU-23/B 500#
BLU-32/B 500#
MK 77 500#
M 78, 79 750#
BLU-1/B 750#
BLU-27B 800#

MUNITIONS DISPENSERS c/

CBU-1/A, 1A/A Ejector Sys
CBU-2/A, 2A/A, 2B/A Ejector Sys
CBU-3/A, 3A/A Ejector Sys
CBU-7/A Ejector Sys
CBU-14/A, 14A/A Ejector Sys
CBU-23/B Cluster Bomb
CBU-25/A, 25A/A, 25B/A Ejector Sys
SADEYE Cluster Bomb

DISPENSED SUBMUNITIONS d/

BLU-3/B Bomblet
BLU-4/B Bomblet
BLU-7/B Anti-Armor
BLU-18/B Bomblet
BLU-24/B Jungle Bomblet
BLU-26/B Bomblet
M40 Bomblet

GUN PODS e/

SUU-11/A, 11A/A 7.62mm
SUU-12/A, 22/A .50 cal
SUU-16/A 20mm
MK 4 20mm
NAVAL GUNS 5", 6", & 8"

ROCKETS f/

2.75" FFAR
5.0 FFAR (ZUNI)

MISSILES g/

AGM-12C BULLPUP B
AGM-45A SHRIKE
AGM-62A WALLEYE
AIM-4D, F, G FALCON
AIM-7D, E, F SPARROW
AIM-9B, C, D SIDEWINDER
AIM-26B FALCON
RIM-2C, D, F TERRIER
RIM-8E TALOS
RIM-24B, C TARTAR

a/ See tables 1 through 12
b/ See tables 13 through 18
c/ See tables 19 through 26
d/ See tables 27 through 33
e/ See tables 34 through 38
f/ See tables 39 through 40
g/ See tables 41 through 54
h/ See tables 54A through 54D

MINES, WATER h/

Mk 25
Mk 36
Mk 50
Mk 52

~~SECRET~~

TABLE 1

MUNITIONS DATA SHEET		BOMBS													
DESIGNATION		CATEGORY OF BOMB	PHYSICAL CHARACTERISTICS												
MODEL AN-M57A1		Air-to-Air	LENGTH 47.8" 62.5"												
NAME 250 Lb GP		TARGETS	DIAMETER 10.8" 10.8"												
SERVICE USAF		Anti-materiel	SPAN 14.9" 15.0"												
MANUF.		Anti-personnel	WEIGHT 272 lb (M106) 289 lb (M126)												
WEAPON CHARACTERISTICS		PERFORMANCE CHARACTERISTICS													
WARHEAD		RANGE													
FILLER 136 lb Tritonal		ALTITUDE													
FUZING Contact, delay, or proximity		FLIGHT TIME													
KILL MECH. Blast and fragmentation		ACCURACY													
LETHAL AREA		Pk (SINGLE SHOT)													
LAUNCH CHARACTERISTICS		USING AIRCRAFT													
SUSPENSION 14" lugs		T-28													
DELIVERY MODE Dive or level		A-1E													
RELEASE MODE Single, stick or salvo		B-26													
LIMITATIONS 480 KIAS, 6 g's		B-57													
STABILIZATION	FUZES	STATUS Inventory													
Fins	Nose	<table border="1"> <tr><td>DATE</td><td></td><td></td><td></td><td></td><td></td></tr> <tr><td>NO</td><td></td><td></td><td></td><td></td><td></td></tr> </table>		DATE						NO					
DATE															
NO															
M106 Box fin for internal carriage	AN-103A1 M163														
	AN-140A1 M164														
	AN-139A1 M188														
M126 Conical fin for external carriage	Mk283 Mod C AN-M166														
	Mk284 Mod 1 AN-M168														
	M904E1														
	Tail														
	AN-M100A2 M172														
	M112A2 M175														
	M123A1														
OPERATING SEQUENCE															
REMARKS															
															

TABLE 2

MUNITIONS DATA SHEET		BOMBS
DESIGNATION MODEL Mx81 NAME 250 lb GP LD SERVICE USN/USAF MANUF.		PHYSICAL CHARACTERISTICS LENGTH 74.1 in DIAMETER 9.0 in SPAN 12.61 in WEIGHT 260 lb
WEAPON CHARACTERISTICS WARHEAD FILLER 96 lb H-6 FUZING Contact, delay or proximity KILL MECH. Fragmentation & blast LETHAL AREA		PERFORMANCE CHARACTERISTICS RANGE ALTITUDE FLIGHT TIME ACCURACY P _K (SINGLE SHOT)
LAUNCH CHARACTERISTICS SUSPENSION 14" lugs DELIVERY MODE Dive or level RELEASE MODE Single, stick or salvo LIMITATIONS Mach 1.3, + 6 to -2 g's		USING AIRCRAFT A-1E T-28 B-26 B-57 A-7A F-100 F105 F-4C F-111
STABILIZATION	FUZES Nose W500E1 AN-M103A1 M163 AN-M139A1 M164 AN-M140A1 M188 Mk243 Mod 0 W910 Mk244 Mod 1 AN-M166 FWD-26/B AN-168 FWD-35/B T811 W500E2 FWD-26/B W500E3 FWD-35/B W910 FWD-35/B	STATUS Inventory (Navy) Procurement (USAF) AVAILABILITY DATE NO
OPERATING SEQUENCE		
REMARKS <div style="text-align: center;">  </div>		

~~SECRET~~

TABLE 3

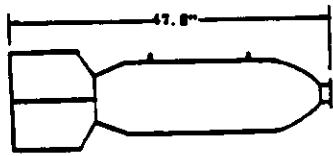
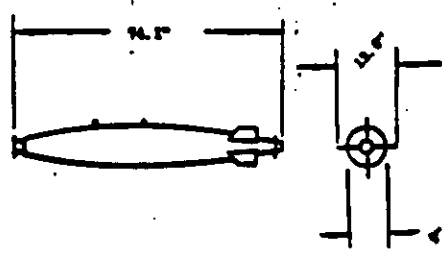
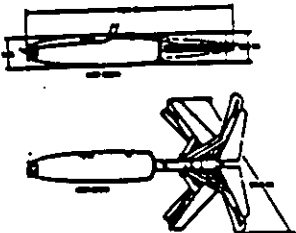
MUNITIONS DATA SHEET		BOMBS																
DESIGNATION MODEL Mx81 R NAME SNAKEYE I SERVICE USN MANUF.		CATEGORY RETARDED OF BOMB AIR-CO OF TYPE TARGETS Anti-materiel Anti-personnel	PHYSICAL CHARACTERISTICS LENGTH 75.2" DIAMETER 9.0" SPAN 12.8" (retracted) WEIGHT 295 lb 54.3" extended fin span															
WEAPON CHARACTERISTICS WARHEAD FILLER 96 lb H-6 FUZING Contact, delay, proximity KILL MECH. Blast and fragmentation LETAL AREA		PERFORMANCE CHARACTERISTICS RANGE ALTITUDE 100 ft (min) FLIGHT TIME ACCURACY Pk (SINGLE SHOT) a/																
LAUNCH CHARACTERISTICS SUSPENSION 14" lugs DELIVERY MODE Dive or low level RELEASE MODE Single, stick or salvo LIMITATIONS 600 kts Retarded or unretarded release option		USING AIRCRAFT F-100 F-105 F-4C F-111 A-7A T-28 A-1E B-26 B-57																
STABILIZATION <u>Fins</u> Mx 14 Mod O retarding tact easy on standard Mx 81 GP	FUZES Nose R904E1 FNU-26/B FNU-35/B FNU-54/B Tail FNU-54B	STATUS Inventory AVAILABILITY DATE NO																
OPERATING SEQUENCE																		
REMARKS a/ Single-pass Pk estimates for single bomb/stick of 6																		
Lt tank A/c in' revet Wood barracks FOL tanks	<table border="1"> <thead> <tr> <th></th> <th>Unretard</th> <th>Retarded</th> </tr> </thead> <tbody> <tr> <td></td> <td>.04/.15</td> <td>.09/.28</td> </tr> <tr> <td></td> <td>.01/.05</td> <td>.02/.14</td> </tr> <tr> <td></td> <td>.01/.02</td> <td>.03/.09</td> </tr> <tr> <td></td> <td>.01/.02</td> <td>.04/.13</td> </tr> </tbody> </table>		Unretard	Retarded		.04/.15	.09/.28		.01/.05	.02/.14		.01/.02	.03/.09		.01/.02	.04/.13		
	Unretard	Retarded																
	.04/.15	.09/.28																
	.01/.05	.02/.14																
	.01/.02	.03/.09																
	.01/.02	.04/.13																

~~SECRET~~

EB-9c

Table 3 to
Annex B to
Appendix E

~~SECRET~~

TABLE 4

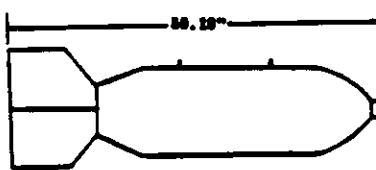
MUNITIONS DATA SHEET		BOMBS	
DESIGNATION MODEL AN-M64A1 NAME 500 lb GP SERVICE USAF WARUF.		CATEGORY OF BOMB Air-to-Surface TARGETS Anti-materiel Anti-personnel	
		PHYSICAL CHARACTERISTICS LENGTH 59.16" 72.1" DIAMETER 14.0" 14.0" SPAN 18.9" 19.6" WEIGHT 551 lb (M109) 586 lb (M128)	
WEAPON CHARACTERISTICS WARHEAD FILLER 283 lb Tritonal FUZING Contact, delay or proximity KILL MECH. Blast & fragmentation LETHAL AREA		PERFORMANCE CHARACTERISTICS RANGE ALTITUDE FLIGHT TIME ACCURACY P _R (SINGLE SHOT)	
LAUNCH CHARACTERISTICS SUSPENSION 14" lugs DELIVERY MODE Dive or level RELEASE MODE Single, stick or salvo LIMITATIONS 550 KIAS, 4 g's		USING AIRCRAFT T-28 A-1E B-26 B-57 F-100	
STABILIZATION Fins M109 Box fin for internal carriage M128 Conical fin for external carriage	FUZES None AN-M103A1 M163 AN-M139A1 M164 AN-M140A1 M188 Mx243 Mod 0 AN-M166 Mx244 Mod 1 AN-M168 M904E1 T411 AN-M101A2 M133 M113A1 M172 M124A1 M175	STATUS Inventory AVAILABILITY DATE NO	
OPERATING SEQUENCE			
REMARKS 			

~~SECRET~~

EB-9d

Table 4 to
Annex B to
Appendix E

~~SECRET~~

TABLE 5

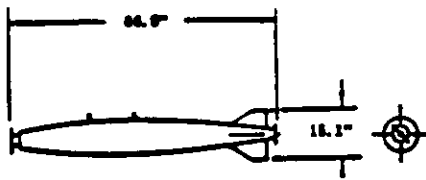
MUNITIONS DATA SHEET		BOMBS			
DESIGNATION MODEL Mx B2 Mod 1 NAME 500 lb GPLD SERVICE USN/USAF MANUF.		CATEGORY LOW DRAG OP EPFB Air-to- TARGETS surface Anti-materiel Anti personnel			
WEAPON CHARACTERISTICS WARHEAD FILLER 192 lb Tritonal FUZING KILL MECH. Blast & fragmentation LETHAL AREA		PHYSICAL CHARACTERISTICS LENGTH 86.9" DIAMETER 10.75" SPAN 15.1" WEIGHT 531 lb			
LAUNCH CHARACTERISTICS SUSPENSION 14" lugs DELIVERY MODE Dive or level RELEASE MODE Single, stick or salvo LIMITATIONS Mach 1.3 (max), +6 to -2 g's		PERFORMANCE CHARACTERISTICS RANGE ALTITUDE FLIGHT TIME ACCURACY P _R (SINGLE SHOT)			
USING AIRCRAFT A-1E T-28 B-26 B-57 A-7A F-100 F-105 F-4C F-111		STATUS Inventory (Navy) Procurement (USAF)			
STABILIZATION		FUZES None M902E1 AN-M103A1 M163 AN-M139A1 M164 AN-M140A1 M188 Mk243 Mod 0 M910 Mk244 Mod 1 AN-M166 FPU-26/B AN-M168 FPU-35/B Tail M905 FPU-26/B M906 FPU-35/B		AVAILABILITY DATE NO	
OPERATING SEQUENCE					
REMARKS <div style="text-align: center;">  </div>					

~~SECRET~~

EB-9e

Table 5 to
Annex B to
Appendix E

~~SECRET~~

TABLE 6

MUNITIONS DATA SHEET		BOMBS																	
DESIGNATION MODEL Mk 82 R NAME SNAKEYE I SERVICE USN MANUF.		PHYSICAL CHARACTERISTICS LENGTH 89. " DIAMETER 10.8" SPAN 15.0" (retracted) WEIGHT 571 lb 65.0" extended fin span																	
WEAPON CHARACTERISTICS WARHEAD FILLER 192 lb Tritonal FUZING Contact, delay or proximity KILL MECH Blast & fragmentation LETHAL AREA		PERFORMANCE CHARACTERISTICS RANGE ALTITUDE 100 ft (min) FLIGHT TIME ACCURACY Pk (SINGLE SHOT) Rema5ks (1)																	
LAUNCH CHARACTERISTICS SUSPENSION 14" lugs DELIVERY MODE Dive or low level RELEASE MODE Single, stick or salvo LIMITATIONS 600 KIAS, 100 ft min alt Retarded or unretarded release optional		USING AIRCRAFT F-100 F-105 F-4C F-111 A-7A B-57 A-1E T-28 B-26																	
STABILIZATION Mk 15 Mod 0 retarding tail Assy on standard Mk 82 OP		FUZES Nose: M90M2 FPU-54/B Tail: FPU-54/B																	
		STATUS Inventory Production Available AVAILABILITY DAY: <table border="1"><tr><td> </td><td> </td><td> </td><td> </td><td> </td><td> </td><td> </td><td> </td></tr></table> NO: <table border="1"><tr><td> </td><td> </td><td> </td><td> </td><td> </td><td> </td><td> </td><td> </td></tr></table>																	
OPERATING SEQUENCE																			
REMARKS																			
(1) Single-pass Pk estimates for single bomb/stick of 6																			
	Unretard	Retard																	
Lt tank	.06/.23	.11/.32																	
A/c in revetment	.02/.05	.02/.14																	
Wood barracks	.01/.04	.03/.10																	
Girder bridge	---/.01	.01/.01																	
POL tank	.01/.03	.04/.17																	

~~SECRET~~

EB-9f

Table 6 to
Annex B to
Appendix E

TABLE 7

MUNITIONS DATA SHEET		BOMBS			
DESIGNATION MODEL M117 NAME 750 lb GP SERVICE USAF MANUF.		CATEGORY OF BOMB Air-to-surface TARGETS Anti-materiel (1) Anti-personnel			
		PHYSICAL CHARACTERISTICS LENGTH 86.4 " DIAMETER 16.0 " SPAN 22.8 " WEIGHT 820 lb			
WEAPON CHARACTERISTICS WARHEAD FILLER 386 lb Tritonal FUZING Contact, delay or proximity KILL MECH. Blast & fragmentation LETHAL AREA		PERFORMANCE CHARACTERISTICS RANGE ALTITUDE FLIGHT TIME ACCURACY PK (SINGLE SHOT)			
LAUNCH CHARACTERISTICS SUSPENSION 14" lugs DELIVERY MODE Dive or level RELEASE MODE Single, stick or salvo LIMITATIONS 600 KIAS (max) Impact angle 735° to prevent ricochet		USING AIRCRAFT F-100 F-105 F-4C F-111 B-52 B-57 B-26 A-1E A-7A			
STABILIZATION		FUZES Nose W904E1 Mx283 Mod 0 M163 Mx284 Mod 1 M164 AN-M166 AN-M140A1 M-188 AN-M139A1 AN-M166 AN-M109 PMU-26/B M910 PMU-35/B Tail W905 PMU-26/B W906 PMU-35/B M100 M162		STATUS Inventory AVAILABILITY DATE NO	
OPERATING SEQUENCE					
REMARKS (1) Effective against concrete up to 4 ft thick					
					

TABLE 9

MUNITIONS DATA SHEET		BOMBS																
DESIGNATION MODEL Mx 83 NAME 1000 lb GP LD SERVICE USN MANUF.		PHYSICAL CHARACTERISTICS LENGTH 118.4" DIAMETER 14.0" SPAN 19.6" WEIGHT 985 lb																
WEAPON CHARACTERISTICS WARHEAD FILLER 445 lb H-6 FUZING Contact, delay or proximity KILL MECH. Blast & fragmentation LETHAL AREA		PERFORMANCE CHARACTERISTICS RANGE ALTITUDE FLIGHT TIME ACCURACY P _x (SINGLE SHOT) Remarks (1)																
LAUNCH CHARACTERISTICS SUSPENSION 14" lugs DELIVERY MODE Dive or level RELEASE MODE Single, stick or salvo LIMITATIONS Mach 1.3, +6 to -2 g's		USING AIRCRAFT F-100 F-105 F-4C F-111 A-7A B-57																
STABILIZATION	FUZES Nose W904E1 AN-M139A1 W163 AN-M160A1 W164 AN-M103A1 W188 M224 Mod 0 W910 M224 Mod 1 AN-W166 PMU-26/B AN-W168 PMU-35/B Tail W905 PMU-26/B W906 PMU-35/B W916	STATUS Inventory (Navy) Production Available, out of production AVAILABILITY DATE NO																
OPERATING SEQUENCE																		
REMARKS (1) Single-pass P _x estimates <table border="1" style="margin-left: 20px;"> <thead> <tr> <th></th> <th>1 Bomb</th> <th>Stick of 6</th> </tr> </thead> <tbody> <tr> <td>Lt tank</td> <td>.10</td> <td>.15</td> </tr> <tr> <td>A/C in revetment</td> <td>.02</td> <td>.02</td> </tr> <tr> <td>Wood barrack</td> <td>.02</td> <td>.03</td> </tr> <tr> <td>POL tank</td> <td>.01</td> <td>.01</td> </tr> </tbody> </table> <div style="margin-left: 20px;">  </div>					1 Bomb	Stick of 6	Lt tank	.10	.15	A/C in revetment	.02	.02	Wood barrack	.02	.03	POL tank	.01	.01
	1 Bomb	Stick of 6																
Lt tank	.10	.15																
A/C in revetment	.02	.02																
Wood barrack	.02	.03																
POL tank	.01	.01																

~~SECRET~~

TABLE 8

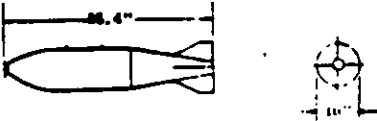
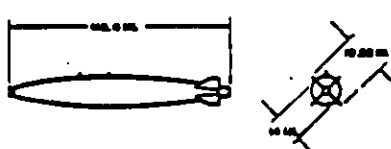
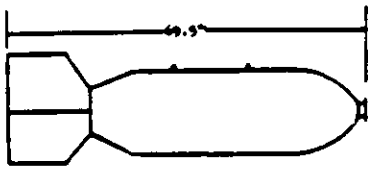
MUNITIONS DATA SHEET		BOMBS	
DESIGNATION MODEL AN-M65A1 NAME 1000 lb GP SERVICE MANUF.		CATEGORY OF BOMB Air-to-surface Targets Anti-materiel	
WEAPON CHARACTERISTICS WARHEAD FILLER 595 lb Tritonal FUZING Impact, delay or proximity KILL MECH. Blast & cratering LETHAL AREA		PHYSICAL CHARACTERISTICS LENGTH 69.5" 91.1" DIAMETER 18.8" 18.8" SPAN 25.4" 26.2" WEIGHT 1104 lb (M113A1) 1205 lb (M129)	
LAUNCH CHARACTERISTICS SUSPENSION 14" lugs DELIVERY MODE Dive RELEASE MODE Single, stick or salvo LIMITATIONS 550 Kts, 2 g's		PERFORMANCE CHARACTERISTICS RANGE ALTITUDE FLIGHT TIME ACCURACY P _R (SINGLE SHOT)	
USING AIRCRAFT A-1E B-26 B-57		STATUS Inventory	
STABILIZATION M113A1 Box fin for internal carriage M129 Conical fin for external carriage		FUZES Nose AN-M103A1 AN-M166 AN-M139A1 AN-M168 AN-M140A1 M163 M2243 Mod 0 M164 M2244 Mod 1 M188 M904M1 Tail (M113A) (M129) AN-102A2 M176 M125A1 M184	
		AVAILABILITY DATE NO	
OPERATING SEQUENCE			
REMARKS <div style="text-align: center;">  </div>			

~~SECRET~~

EB-9h

Table 8 to
Annex B to
Appendix E

~~SECRET~~

TABLE 10

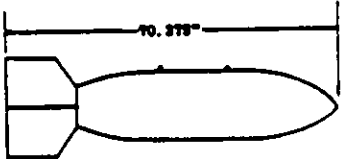
MUNITIONS DATA SHEET		BOMBS																
DESIGNATION MODEL AN-M59A1 NAME 1000 lb SAP SERVICE MANUF.		CATEGORY SAP BOMB Air-to-surface TARGETS Reinforced concrete Light armored ship- ping PHYSICAL CHARACTERISTICS LENGTH 70.38" DIAMETER 15.1 " SPAN 20.72" WEIGHT 1033 lb																
WEAPON CHARACTERISTICS WARHEAD Semi-Armor Piercing FILLER 312.6 lb Picratol or 292.6 lb Amatol FUZING AN-M162 delay KILL MECH. Blast & cratering LETHAL AREA		PERFORMANCE CHARACTERISTICS RANGE ALTITUDE FLIGHT TIME ACCURACY P _K (SINGLE SHOT)																
LAUNCH CHARACTERISTICS SUSPENSION 14" lugs DELIVERY MODE level RELEASE MODE Single, stick or salvo LIMITATIONS		USING AIRCRAFT B-47 B-52																
STABILIZATION M114A1 Box fin, internal carriage only	FUZES	STATUS Inventory AVAILABILITY <table border="1"> <tr> <td>DATE</td> <td></td> <td></td> <td></td> <td></td> <td></td> <td></td> <td></td> </tr> <tr> <td>NO</td> <td></td> <td></td> <td></td> <td></td> <td></td> <td></td> <td></td> </tr> </table>	DATE								NO							
DATE																		
NO																		
OPERATING SEQUENCE																		
REMARKS <div style="text-align: center;">  <p>70.375"</p> </div>																		

~~SECRET~~

EB-9j

Table 10 to
Annex B to
Appendix E

~~SECRET~~

TABLE 11

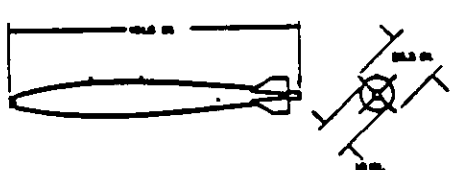
MUNITIONS DATA SHEET		BOMBS																			
DESIGNATION MODEL Mk B4 NAME 2000 lb LD OP SERVICE USN MANUF.		CATEGORY LOW DRAG OF BOMB Air-to-sur-TARGETS face PHYSICAL CHARACTERISTICS LENGTH 151.5" DIAMETER 18.0" SPAN 25.3" WEIGHT 1970 lb																			
WEAPON CHARACTERISTICS WARHEAD FILLER 945 lb H-6 FUZING Contact, delay or proximity KILL MECH. Blast & cratering LETHAL AREA		PERFORMANCE CHARACTERISTICS RANGE ALTITUDE FLIGHT TIME ACCURACY P _k (SINGLE SHOT) Remarks (1)																			
LAUNCH CHARACTERISTICS SUSPENSION 30" lugs DELIVERY MODE Level RELEASE MODE Single, single or salvo LIMITATIONS 600 kts, 4 g's		USING AIRCRAFT B-47 B-52 F-100 F-105 F-8C A-7A F-111																			
STABILIZATION		FUZES None W904M1 AN-M139A1 M163 AN-M140A1 M164 AN-M103A1 M188 Mk243 Mod 0 W910 Mk244 Mod 1 AN-M166 FWD-26/B AN-M168 FWD-35/B Tail W905 FWD-26/B W906 FWD-35/B W910		STATUS Inventory (Navy) Rationed in SEA Production starts Sept 67 (300 units), reaching 1500/month by Dec 67 AVAILABILITY <table border="1"> <tr> <td>DATE</td> <td>1967</td> <td>Jan</td> <td>68</td> <td></td> <td></td> <td></td> <td></td> </tr> <tr> <td>NO</td> <td>300</td> <td>1500</td> <td></td> <td></td> <td></td> <td></td> <td></td> </tr> </table>		DATE	1967	Jan	68					NO	300	1500					
DATE	1967	Jan	68																		
NO	300	1500																			
OPERATING SEQUENCE																					
REMARKS (1) Single-pass P _k estimates, single bomb Lt tank .14 A/c in revetment .02 Wood barracks .03 POL tank .01 																					

~~SECRET~~

EB-9k

Table 11 to
Annex B to
Appendix E

~~SECRET~~

TABLE 12

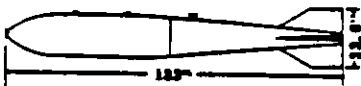
MUNITIONS DATA SHEET		BOMBS													
DESIGNATION MODEL M118 NAME 3000lb Demolition SERVICE USAP MANUF.		CATEGORY DEMOLITION BOMB Air-to-TARGETS surface Anti-materiel PHYSICAL CHARACTERISTICS LENGTH 133" DIAMETER 24.13" SPAN 33.6" WEIGHT 3020 lb													
WEAPON CHARACTERISTICS WARHEAD FILLER 1888 lb Tritonal FUZING Contact, delay or proximity KILL MECH. Blast, cratering LETHAL AREA		PERFORMANCE CHARACTERISTICS RANGE ALTITUDE FLIGHT TIME ACCURACY P _R (SINGLE SHOT)													
LAUNCH CHARACTERISTICS SUSPENSION 30" lugs DELIVERY MODE Level RELEASE MODE Single, stick or salvo LIMITATIONS 600 KIAS, +6 to -2.5 g's		USING AIRCRAFT F-105 F-4C F-100 F-111 A-7A													
STABILIZATION	FUZES None AN-M103A1 M-163 AN-M139A1 M-164 AN-M140A1 M-188 AN-M166 M-904E1 AN-M168 M-910 Mk243 Mod 0 FWD-26/B Mk244 Mod 1 FWD-35/B Tail M-905 FWD-26/B M-906 FWD-35/B M-910	STATUS Inventory Rationed in SEA Production Out of production, BLU-31/B is a possible replacement AVAILABILITY <table border="1"> <tr> <td>DATE</td> <td>MAFOT</td> <td></td> <td></td> <td></td> <td></td> </tr> <tr> <td>NO</td> <td>5594</td> <td></td> <td></td> <td></td> <td></td> </tr> </table>		DATE	MAFOT					NO	5594				
DATE	MAFOT														
NO	5594														
OPERATING SEQUENCE															
REMARKS (1) Designed so that about 65% of the total bomb weight is explosive charge to provide a greater blast effect than a GP bomb of comparable weight. 															

~~SECRET~~

EB-91

Table 12 to
Annex B to
Appendix E

TABLE 13

MUNITIONS DATA SHEET		BOMBS	
DESIGNATION		CATEGORY FIRE	PHYSICAL CHARACTERISTICS
MODEL	BLU-10/B	BOMB TARGETS Anti-materiel Anti-personnel	LENGTH 88.4"
NAME			DIAMETER
SERVICE			SPAN
MANUF.			WEIGHT 250 lb
WEAPON CHARACTERISTICS		PERFORMANCE CHARACTERISTICS	
WARHEAD	Incendiary	RANGE	
FILLER	35 Gal Napalm	ALTITUDE	
FUZING	Impact, nose and tail	FLIGHT TIME	
KILL MECH.	Incendiary effects	ACCURACY	
LETHAL AREA		P_r (SINGLE SHOT)	
LAUNCH CHARACTERISTICS		USING AIRCRAFT	
SUSPENSION	14" lugs	T-28 A-1K B-26 B-57 F-100 F-105 F-4C F-111 A-7A	
DELIVERY MODE	Shallow dive, low level		
RELEASE MODE	Single, paired, or salvo		
LIMITATIONS	600 KIAS, +5 to -2's		
STABILIZATION	FUZES	STATUS	
Unfired aluminum tank developed primarily for aircraft prohibiting use of the heavier BLU-1/B and BLU-23/B	FWU-7/B (nose & tail) M23A1 Igniter (wp)		
		AVAILABILITY	
		DATE	
		NO	
OPERATING SEQUENCE			
REMARKS			
<p>A technical drawing of a cylindrical bomb. A horizontal dimension line above the bomb indicates a length of 88.4 inches. A small rectangular box labeled 'Fuze' is positioned on the side of the bomb, near the front (nose) end.</p>			

TABLE 38

MISSION AND DESCRIPTION		
<p align="center"><u>B-52</u></p> <p>Long range day or night all weather strategic bomber for delivery of nuclear or conventional weapons, and at either high or low altitudes. In addition to its primary bomb-load the aircraft has the capability to carry two air-launched AGM-28 (HOUND DOG) guided missiles, and/or four ADM-20 (QUALL) decoys. The normal crew of six consists of pilot, co-pilot, (2) bombardier-navigators, ECM operator and tail gunner. Automatic cabin pressurization, heating and ventilation are provided for crew. Flight control is accomplished by use of spoilers and ailerons on the wing; elevators on an all-movable horizontal tail and a rudder on a fixed vertical tail surface. The spoilers also function as air brakes used in landing.</p>		
OPERATING DATA		AVAILABILITY/DEVELOPMENT
<p>Speed: Cruise 445K Max Design 495K Altitude: 52,000' Range: Conventional High-Unref 4420 NM, Ref 6567NM</p>		<p>155 B-52D Acft Avail 85 Committed to SIOP Mission 70 Committed to conventional Mission</p> <p>GUAM - 70 U-Tapao (When authorized) - 15</p>
WEIGHTS	FUEL AND OIL	DIMENSIONS
<p>Loading LB Empty 164,486 Design 453,000 Max T.O. 450,000 Max Land 270,000</p>	<p>41,550 gal. JP-4</p>	
ELECTRONICS		ORDNANCE
<p>UHF ARC-34 IFF APX-25 Radar Beacon APN-69 ECM Recvr (1) APN-14 Bombing Sys ASB-15 Nav Recv'r ARN-14 Glide Path ARN-18 Marker Beacon ARN-12 Early Warning APS-9 Chaff ALE-27 TACAN ARN-21 Srch Radr APS-104 Doppler Rado APN-108 ECM Trans (2) ALR-18 ECM Trans (4) ALT-13 ECM Trans (1) ALT-16 ECM Trans (3) ALT-15 ECM Trans (3) ALT-6B</p>		<p>(U) <u>Conventional</u> Nr. 108 MK 82 500# GP Bombs 66 M-117 750# GP Bombs 144 ADU-253 Canisters (BLU-3B) 144 ADU-272 Canisters (BLU-26B)</p> <p>(S) Nr. Type* 4 MK-28 2 MK-41 4 MK-43 2 MK-53</p> <p>* Concurrent w/these internal nuclear loads two AGM-28 missiles may be carried externally.</p>

~~SECRET~~

TABLE 37-

MISSION AND DESCRIPTION		
<p style="text-align: center;"><u>KC-135A</u></p> <p>The principle mission of the KC-135A is the long range aerial refueling of turbine powered aircraft. The aircraft is designed for alternate use as a high performance transport. The crew consists of pilot, co-pilot, navigator, and boom operator.</p> <p>The aircraft is provided with double slotted flaps and partial leading edge flaps. Spoilers are used in conjunction with ailerons for lateral control. The spoilers are also used as speed brakes to provide for high descent rates and decreased landing distances. Power boosted rudder capability on these aircraft will increase the control during low speed flight and ground operations.</p> <p>All body fuel is carried in the lower lobe and on the upper deck aft of the pressurized area, providing a large unobstructed cargo volume on the upper deck.</p>		
OPERATING DATA		AVAILABILITY/DEVELOPMENT
Current fighter - tanker ratio is 8:1 Off load - 8,500 to 12,500 gal.. Re-fuel altitudes 23-26,000'		PACCS Relay - 2 ARC Light - 45 PACAF Fighter Re-fueling - 35 Takhli - 10 U-Tapao - 25
WEIGHTS	FUEL AND OIL	DIMENSIONS
Loading Lb Empty 97,030 (A) Design 300,800 Combat 122,020 Max. T.O. 300,800 Max. Lndg 222,000	Limited by Max. T.O. Gross weight to 30,013 gallons Spec. MIL-F-5624A Grade JP-4	Wing Span 130.8' Sweepback (LE) 37° 33' (25% Chord) 35° Length 136.2' Height 47.1' t read 22.1'
ELECTRONICS		ORDNANCE
Marker Beacon (1) AN/ARN-12 Marker Beacon (2) AN/ARN-32 Navig. Radar (3) AN/APN-82 UHF Navig. (Tacan) (4) AN/ARN-21 Navig. Radar (4) AN/APN-99 H.F. Liaison (5) AN/ARC-65 H.F. Liaison (6) AN/ARC-58 Remotely Beacon (7) AN/APN-134 Interphone AN/AIC-10 UHF Command AN/ARC-34		

~~SECRET~~

EA-19k

Table 37 to
Annex A to
Appendix E

TABLE 39

MISSION AND DESCRIPTION		
<p style="text-align: center;"><u>F-4D</u></p> <p>The F-4D is a two place, twin engine, jet capable of all-weather air-to-air intercept with four Sparrow and four AIM-4D Falcon missiles. Intercept radar has a 200NM range with target lock-on of 50NM. Improved gun sight offers lead computing capabilities and radar-ranging for improved air-ground accuracy. Externally mounted gun pod only. Visual attack w/ conventional and nuclear externally hung weapons. Navigation aids: TACAN, UHF/DF, Inertial Navigation System, limited radar ground mapping. Air Refuelable. Automatic flight control system w/control stick steering. Manned by two pilots.</p>		
OPERATING DATA		AVAILABILITY/DEVELOPMENT
Ferry Range: 1713NM Refuel: unlimited Cmt Cell: 53,650' Cmt Wt: 42,813# Cmt Config: 2-370's Rate of climb: 36,500' FPM		FY-67 production 518 FY-68 production 207 SEF attrition: ESI FY-68-36 FY-69-151 Korat 2/68 36A/C Udorn 2/68 18A/C
WEIGHTS	FUEL AND OIL	DIMENSIONS
Max Gross: 58000# Int. Fuel only: 46,110# Max Land wt: 46,000# T.O. Roll Max wt: 4500! * Design limits-can be exceeded for special missions	JP-4 Total 3,229 gal Internal 1,889 gal Start: Air unit cartridge	
ELECTRONICS		ORDNANCE
RHAW... APS 107 Main Time - 72 F-4D's Sky Spot X-Band receiver (All MUDs to be incorporated) QRC-334 (TDA) QRC-160-1 QRC-160-R		CBU-24 SUU-25 Flare Pod Wild Weasel: 36 A/C for SEA - MOD Wall Eye Missile (See external stores loading chart.)

CHARACTERISTICS FOR US AIR FORCE AIRCRAFT^{a/}
TO BE DEPLOYED TO SOUTHEAST ASIA
DURING FY 1968

F-4D

a/ See Table 39

EA-20

Annex A to
Appendix E

TABLE 40

MISSION AND DESCRIPTION		
A-7D		
<p>The USAF A-7D is a single-place, single engine, light attack fighter airplane produced by Ling-Tempo-Vought. Powered by the Allison TF-41 nonafterburning turbofan engine which provides a high subsonic level flight capability, and an extended radius of action with a long loiter time over the target area. Armament includes M61 gatling type 20mm cannon capable of 6000 rounds/minute. Eight external stores station provide the capability to carry a wide variety of conventional ordnance in loads up to 15,000 pounds. Aircraft will deliver air-to-surface non-nuclear weapons in visual weather.</p>		
OPERATING DATA		AVAILABILITY/DEVELOPMENT
One Pilot Ferry Range.....3,370nm Speed (w/payload).....525 kts Combat Ceiling.....40,000' T.O. Roll.....4,380' Air Refueling Provisions		Now in Production First AF Delivery - July 68 (test with TF-41 engine) Deliveries - FY 69-80 FY 70-71 - 238/Yr First opnl. wing - June 1969 DEPLOYMENT SEA - Possible FY 70
WEIGHTS	FUEL AND OIL	DIMENSIONS
T.O. Gross.....38,342 lbs (8,200 lbs payload) Combat Max.....45,000 lbs	JP-4 1500 gal (internal)	
ELECTRONICS		ORDNANCE
Radar Beacon.....APN-154 Doppler Radar.....APN-153 Radar Altimeter.....APN-141 Nav Computer.....ASN-41 Radar Homing & Warning.....APS-107R Strike Camera.....KB-18 Bullpup Command TMxTR.....ARW-77 Secure Voice.....KY-28 IFF/SIF.....APX-64 ECM Control.....U-487		GP Bombs Firebombs Mines Rockets C/B Dispensers Eye Series weapons Bullpup Sidewinder Maverick Shrike M61 A1 Cannon External Tanks

CHARACTERISTICS FOR US AIR FORCE AIRCRAFT^{a/}
TO BE DEPLOYED TO SOUTHEAST ASIA
AFTER FY 1968

A-7D
F-4E
F-111A

a/ See Tables 40 through 42

EA-21

Annex A to
Appendix E

TABLE 41

MISSION AND DESCRIPTION		
F-4E		
<p>The F-4E is a two-place, twin engine, jet fighter. Capabilities: all-weather, air-to-air intercept and missile combat with 4 Sparrows and 4 Falcon missiles, also internal 20MM cannon and lead computing sight. Improved radar for low level lock-on capability. Radar has 200NM range and 50NM target lock-on capability. Visual employment of conventional and nuclear external mounted weapons plus internal 20MM cannon. Larger engine and more fuel improves entire performance envelope. Navigational aids are: TACAN, SHF/DF, improved navigation computer and limited radar ground mapping.</p> <p>Air refuelable; also has automatic flight control system with control stick steering. Manned by two pilots.</p>		
OPERATING DATA		AVAILABILITY/DEVELOPMENT
Ferry Range.....1950 Refuel.....Unlimited Cmbt Ceiling.....57,000 Cmbt Weight.....41,109 lbs Cmbt Config.....4 Sparrow Max Climb Mach.....2.25		Production.....Aug 67-Jul 71 FY 69.....125 FY 70.....171
WEIGHTS	FUEL AND OIL	DIMENSIONS
Max Gross.....58,000 lbs ^{a/} Int Fuel Only.....46,000 lbs ^{a/} Max Land Wt.....46,000 lbs T.O. Roll(Max Wt)4300 ft ^{a/} Design limits can be exceeded for special missions	JP-4 Total.....3324 gal Oil.....MIL-L-7808 Oil Cap.....10.3 Start.....Air Unit Cartridge	
ELECTRONICS		ORDNANCE
Fire Control Sys Cords.....APQ-120 Optical Sight.....ASG-22 Other Gear & Mods same as F-4D		Same as F-4D except: Internal 20MM Cannon

TABLE 42

MISSION AND DESCRIPTION		
F-111A		
<p>The F-111A is a tactical fighter with characteristics which will provide all-weather operations for close support, interdiction and penetration missions. Used in secondary role for the defense of tactical environment. Uses full spectrum of nuclear and non-nuclear tactical armaments and air-to-air GAR type infrared missiles which can be carried on the eight external store stations. Long ferry range allows non-stop deployment. Two pilots.</p>		
OPERATING DATA		AVAILABILITY/DEVELOPMENT
Max Speed.....1.2 S.L., 2.5 @ alt Ferry Range.....3,260 (Int Fuel) Combat Ceiling.....57,680 In-Flight Refueling		In Production Delivery to Operational Units Approx 1/month Oct 67 Building to Approx 12/month by End CY 68 DEPLOYMENT First TFW at Cannon AFB, N.M.....Early FY 69
WEIGHTS	FUEL AND OIL	DIMENSIONS
Design Mission...80,449 lbs Empty Wt.....43,509 lbs	JP-4 4,641 gal (internal)	
ELECTRONICS		ORDNANCE
HHAW APS-109 IR Warning & Decoy Flares ALH-73 AIL-25 MSN & Trf Control JHE/HF MK 11 Ground to Air Data Link		Weapons Bay Gun AIM-4D Missile LAU - 1/A RKT Launcher CBU-24/B (24) MK-82 Walleye MK I Mod 0(6) NVC Ear Wpns

~~SECRET~~

TABLE 14

MUNITIONS DATA SHEET		BOMBS	
DESIGNATION MODEL BLU-23/B NAME SERVICE USAF MANUF.		CATEGORY FIRE BOMB Air-to-surface TARGETS Area targets Personnel, light structures, vehicles, emplacements, etc.	
WEAPON CHARACTERISTICS WARHEAD Incendigel FILLER 75 gal Napalm FUZING Incendiary effects KILL MECH. LETHAL AREA		PHYSICAL CHARACTERISTICS LENGTH 119" DIAMETER 15.75" SPAN WEIGHT	
LAUNCH CHARACTERISTICS SUSPENSION 14" lugs DELIVERY MODE Shallow dive or low level RELEASE MODE Single, paired or salvo LIMITATIONS 600 KIAS, +5 to -2 g's		PERFORMANCE CHARACTERISTICS RANGE ALTITUDE FLIGHT TIME ACCURACY P _R (SINGLE SHOT)	
USING AIRCRAFT A-1E T-28 B-26 B-57 F-100 F-105 F-80 F-111		STATUS Production	
STABILIZATION Unfinned, bolted aluminum tank		FUZES PMU-7/B (nose & tail)	
		AVAILABILITY DATE NO	
OPERATING SEQUENCE			
REMARKS Developed primarily for SAW aircraft prohibited from using the heavier BLU-1/B/BLU-27/B because of pylon load limitations. Bolted Aluminum tank loaded in the field.			

~~SECRET~~

EB-9n

Table 14 to
Annex B to
Appendix E

TABLE 15

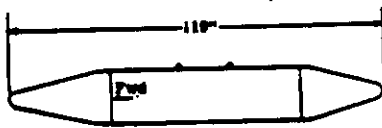
MUNITIONS DATA SHEET		BOMBS	
DESIGNATION		CATEGORY PIRE	PHYSICAL CHARACTERISTICS
MODEL	BLU-32/B	BOMB Air-to-surface	LENGTH 119"
NAME		TARGETS area targets Personnel, light structures, vehicles, emplacements, etc.	DIAMETER 15.75"
SERVICE	USAF		SPAN
MANUF.			WEIGHT 595 lb
WEAPON CHARACTERISTICS		PERFORMANCE CHARACTERISTICS	
WARHEAD	Incendiary	RANGE	
FILLER	67 gal Napalm B	ALTITUDE	
FUZING	Impact, nose & tail	FLIGHT TIME	
KILL MECH.	Incendiary effects	ACCURACY	
LETHAL AREA		P_K (SINGLE SHOT)	
LAUNCH CHARACTERISTICS		USING AIRCRAFT	
SUSPENSION	14" lugs	A-1E	
DELIVERY MODE	Shallow dive or low-level	T-28	
RELEASE MODE	Single, paired or salvo	B-26	
LIMITATIONS	600 KIAS, +5 to -2 g's	B-57	
		F-100	
		F-105	
		F-8C	
		F-111	
STABILIZATION	FUZES	STATUS Production	
Unfinned	FNU-7/B		
		AVAILABILITY	
		DATE	
		NO	
OPERATING SEQUENCE			
REMARKS			
A welded version of the BLU-23/B, delivered prefilled with NAPALM-B.			
			

~~SECRET~~

TABLE 16

MUNITIONS DATA SHEET		BOMBS	
DESIGNATION MODEL MK 77, 78, 79 NAME Fire Bombs SERVICE USN MANUF.		CATEGORY FIRE BOMB Air-to-Surface TARGETS Anti-materiel/ Personnel	
WEAPON CHARACTERISTICS WARHEAD INCENDIJEL FILLER NAPALM FUZING Impact, nose and tail KILL MECH. Incendiary effects LETHAL AREA		PHYSICAL CHARACTERISTICS LENGTH (MK77) (MK78,79) DIAMETER SPAN WEIGHT 500 lb 750 lb	
LAUNCH CHARACTERISTICS SUSPENSION DELIVERY MODE Shallow dive or low-level RELEASE MODE Single, paired, or salvo LIMITATIONS 600 KIAS		PERFORMANCE CHARACTERISTICS RANGE ALTITUDE FLIGHT TIME ACCURACY Pk (SINGLE SHOT)	
STABILIZATION		USING AIRCRAFT	
FUZES		STATUS Inventory	
		AVAR ABILITY DATE NO	
OPERATING SEQUENCE			
REMARKS			

~~SECRET~~

EB-9p

Table 16 to
Annex B to
Appendix E

~~SECRET~~

TABLE 17

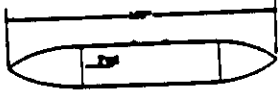
MUNITIONS DATA SHEET		BOMBS	
DESIGNATION MODEL BDU-1/B NAME 750 lb NAPALM SERVICE USAP MANUF.	CATEGORY FIRE BOMB Surface-to-Air TARGETS Area targets Personnel, light structures, vehicles, emplace- ments, etc	PHYSICAL CHARACTERISTICS	
		LENGTH	(Unfin) 130 in (Finned) 130 in
		DIAMETER	18.5 in
		SPAN	19.7 in
		WEIGHT	694 lb
WEAPON CHARACTERISTICS		PERFORMANCE CHARACTERISTICS	
WARHEAD INCENDIJEL		RANGE	
FILLER 100 gal napalm		ALTITUDE	
FUZING Impact, nose & tail		FLIGHT TIME	
KILL MECH. Incendiary effects		ACCURACY	
LETAL AREA		Pk (SINGLE SHOT)	
LAUNCH CHARACTERISTICS		USING AIRCRAFT	
SUSPENSION 14" lugs		P-100	
DELIVERY MODE Shallow dive, or low level		P-105	
RELEASE MODE Single, paired or salvo		P-40	
LIMITATIONS 600 KIAS, 5 g's, external carriage only		P-111	
		A-7A	
		A-1E	
		T-26	
		B-26	
		B-57	
STABILIZATION	FUZES (Nose & Tail)	STATUS Inventory	
Unfinned	FWD-7/B		
A stabilizing fin is currently under development to provide a more reproducible trajectory.	M23A1 igniter (WP)		
		AVAILABILITY	
		DATE	
		NO	
OPERATING SEQUENCE			
REMARKS			
Bolted aluminum tank loaded in the field. 110 gal. tank.			
			

~~SECRET~~

EB-9q

Table 17 to
Annex B to
Appendix E

~~SECRET~~

TABLE 18

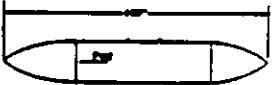
MUNITIONS DATA SHEET		BOMBS							
DESIGNATION MODEL BLU-27/B ^{a/} NAME 750 lb Napalm Bomb SERVICE USAF MANUF.	CATEGORY FIRE BOMB Air-to-Surface TARGETS Area targets Personnel, light structures, vehicles, emplacements, etc.	PHYSICAL CHARACTERISTICS (Unfinned) (Finned) LENGTH 130 in 138 in DIAMETER 18.5 in 18.5 in SPAN - 19.7 in WEIGHT 800 lb							
WEAPON CHARACTERISTICS WARHEAD INCERDIJEL FILLER 100 gal NAPALM-B FUZING Impact, nose and tail KILL MECH. incendiary effects LETHAL AREA		PERFORMANCE CHARACTERISTICS RANGE ALTITUDE FLIGHT TIME ACCURACY P _g (SINGLE SHOT)							
LAUNCH CHARACTERISTICS SUSPENSION 14" lugs DELIVERY MODE Shallow dive or low level RELEASE MODE Single, paired or salvo LIMITATIONS 600 KIAS, 5 g's, external carriage only		USING AIRCRAFT							
STABILIZATION Finned and unfinned versions	FUZES (Nose and tail) FOU-7/B M23A1 igniter (cup)	STATUS <table border="1"><tr><td colspan="2">AVAILABILITY</td></tr><tr><td>DATE</td><td></td></tr><tr><td>NO</td><td></td></tr></table>		AVAILABILITY		DATE		NO	
AVAILABILITY									
DATE									
NO									
OPERATING SEQUENCE									
REMARKS ^{a/} Welded version of BLU-1/B, delivered prefilled with NAPALM-B 									

~~SECRET~~



EB-9r

Table 18 to
Annex B to
Appendix E

TABLE 19

MUNITIONS DATA SHEET		DISPENSED MUNITIONS	
DESIGNATION CBU-1/A, 1A/A ^{a/}	CATEGORY Air-to-Surface TARGETS Area coverage, anti- personnel	PHYSICAL CHARACTERISTICS	
MODEL		LENGTH 118.4 in	
NAME		DIAMETER 15.6 in	
SERVICE USAF		SPAN	
MANUF.		WEIGHT	
WEAPON CHARACTERISTICS ^{c/} OPFRAM ITEM		PERFORMANCE CHARACTERISTICS	
WARHEAD 509 BLD-4A/B Bomblets		RANGE	
FILLER HE		ALTITUDE 50 ft (min)	
FUZING Impact		FLIGHT TIME	
KILL MECH. Fragmentation		ACCURACY	
LETHAL AREA		P _r (SINGLE SHOT)	
LAUNCH CHARACTERISTICS		USING AIRCRAFT	
SUSPENSION		F-100 (2)	
DELIVERY MODE	Low level, highspeed	F-105 (2)	
RELEASE MODE	Two dispensers/coriti ^{b/}	F-4C	
LIMITATIONS	150 Kts (min), 600 Kts (max) 50' min alt, station restrictions on all aircraft.	A-7A	
		B-57	
DISPENSER DATA	FUZES	STATUS Inventory	
The CBU-1/A uses the SUU-7/A dispenser and the CBU-1A/A uses the SUU-7A/A dispenser.			
		AVAILABILITY	
		DATE	
		NO	
OPERATING SEQUENCE			
REMARKS			
<p>^{a/} The CBU-1/A developmental model was procured in limited quantities.</p> <p>^{b/} Release variable from one to three tubes prefiring button depression.</p>			

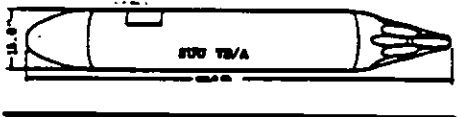
TABLE 20

MUNITIONS DATA SHEET		DISPENSED MUNITIONS	
DESIGNATION 2/A, 2A/A, 2B/A	CATEGORY Dispens- ers, 8250 Targets Area	PHYSICAL CHARACTERISTICS	
MODEL CBU-2		LENGTH 118.2 in	DIAMETER 15.6 in
NAME		SPAN	
SERVICE USAP		WEIGHT 833 lb	
MANUF.			
WEAPON CHARACTERISTICS		PERFORMANCE CHARACTERISTICS	
WARHEAD 409 BLU-3/B Bomblets		RANGE	
FILLER 170gm (RDX or Cyclotol)/Bomblet		ALTITUDE	
FUZING Impact		FLIGHT TIME	
KILL MECH. Fragmentation		ACCURACY	
LETHAL AREA		P _z (SINGLE SHOT)	
LAUNCH CHARACTERISTICS		USING AIRCRAFT	
SUSPENSION 14" lugs		F-100	
DELIVERY MODE Low level, high speed		F-105	
RELEASE MODE Two dispensers/pass		F-4C	
LIMITATIONS 350 Kts (min) 600 kts (max)		B-57	
		A-7A	
DISPENSER DATA ✓	FUZES	STATUS Inventory	
SUU-7/A (CBU-2/A)			
SUU-7A/A (CBU-2A/A)			
SUU-7B/A (CBU-2B/A)			
		AVAILABILITY	
		DATE	
		NO	
OPERATING SEQUENCE			
REMARKS			
<p>✓ The SUU-7A loads only 17 tubes to keep weight below 750 lb, the SUU-7B/A is modified to permit 2, 4, or 6 tube releases per firing (pre-selected on ground).</p>			
			
 			

~~SECRET~~

TABLE 21

MUNITIONS DATA SHEET		DISPENSED MUNITIONS							
DESIGNATION MODEL CBU-3/A, 3A/A NAME SERVICE USAF MARKING		CATEGORY, DIS- PENSED MUNITION TARGETS Area types Anti-tank	PHYSICAL CHARACTERISTICS LENGTH 118.42 DIAMETER 15.6 SPAN WEIGHT 652 lb						
WEAPON CHARACTERISTICS WARHEAD 371 BLU-7/B 352 BLU-7A/B FILLER HE, Shaped charge FUZING Parachute armed, impact fused KILL MECH. Spalling & fragments LETHAL AREA		PERFORMANCE CHARACTERISTICS RANGE ALTITUDE FLIGHT TIME ACCURACY P _E (SINGLE SHOT)							
LAUNCH CHARACTERISTICS SUSPENSION 14" lugs, SUD-10/A DELIVERY MODE High speed, low level (50-150') RELEASE MODE 19 tube salvo LIMITATIONS 350 kts (min), 600 kts (max) or Mach 1.1		USING AIRCRAFT F-100 F-105 F-8C B-57 A-7A							
DISPENSER DATA SUD-10/A	FUZES	STATUS Inventory <table border="1"> <tr> <td colspan="2">AVAILABILITY</td> </tr> <tr> <td>DATE</td> <td></td> </tr> <tr> <td>NO</td> <td></td> </tr> </table>		AVAILABILITY		DATE		NO	
AVAILABILITY									
DATE									
NO									
OPERATING SEQUENCE									
REMARKS <div style="text-align: center;"> <p>BLU-7/B 3000</p> </div>									

~~SECRET~~

EB-9u

Table 21 to
Annex B to
Appendix E

~~SECRET~~

TABLE 22

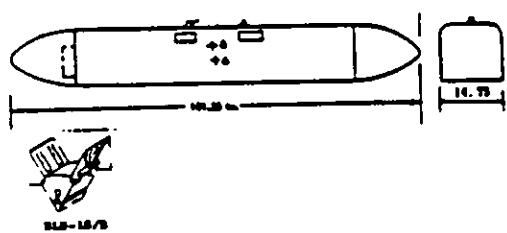
MUNITIONS DATA SHEET		DISPENSED MUNITIONS	
DESIGNATION CBD-7/A MODEL NAME SERVICE USAF MANUF.	CATEGORY DIS- PENSING SYSTEM Air-to-Surface Targets Area targets anti-personnel	PHYSICAL CHARACTERISTICS LENGTH 101.25 in DIAMETER 14.75 in (wide) SPAN 13.74 in (high) WEIGHT 795 lb	
WEAPON CHARACTERISTICS WARHEAD 1200 BLU-18/B FILLER FUZING Impact (BLU-18/B) KILL MECH. LETHAL AREA		PERFORMANCE CHARACTERISTICS RANGE ALTITUDE FLIGHT TIME ACCURACY Pk (SINGLE SHOT)	
LAUNCH CHARACTERISTICS SUSPENSION 14" lugs, All Station incl. MER DELIVERY MODE Low level, high speed RELEASE MODE Ripple fire a/ LIMITATIONS 600 Kts, 4 g's		USING AIRCRAFT F-100 F-105 F-4C F-111 A-7A	
DISPENSER DATA SUU-13/A Dispenser has 40 downward ejection tubes, each with a package of 30 BLU-18/B bomblets, each with individual expulsion cartridge.	FUZES	STATUS Procurement	
		AVAILABILITY DATE NO	
OPERATING SEQUENCE			
REMARKS a/ Tubes fire as long button held down. Rate can be preset on ground (0.1, 0.2, 0.3, 0.4, or 0.5 sec). Normally 2 dispensers fired simultaneously.			
			

~~SECRET~~

EB-9v

Table 22 to
Annex B to
Appendix E

TABLE 23

MUNITIONS DATA SHEET		DISPENSED MUNITIONS	
DESIGNATION	CBU-14/A, 14A/A	CATEGORY	DIS- PENSING SYSTEM 14-14-Surface TARGETS
MODEL		Area coverage	
NAME		Anti-material	
SERVICE	USAF	Anti-personnel	
MANUF.			
PHYSICAL CHARACTERISTICS		PERFORMANCE CHARACTERISTICS	
LENGTH	82 in	RANGE	
DIAMETER	11.28 in (wide)	ALTITUDE	
SPAN	9.3 in (high)	FLIGHT TIME	
WEIGHT	250 lb	ACCURACY	
WEAPON CHARACTERISTICS		Pk (SINGLE SHOT)	
WARHEAD	114 BLU-3/B Bomblets		
FILLER	170gm RDX or Cyclotol per bomblet		
FUZING	Impact		
KILL MECH.	Fragmentation		
LETHAL AREA			
LAUNCH CHARACTERISTICS		USING AIRCRAFT	
SUSPENSION	14" lugs	A-1E	
DELIVERY MODE	Low level	F-28	
RELEASE MODE	Single or ripple	B-26	
LIMITATIONS	400 Kts (max), 4 g's	B-57	
DISPENSER DATA	BUU-14/A (CBU-14 (A) and SUU-14A/A (CBU-14A/A) are 6 tube ejectors.	FUZES	STATUS Procurement
		AVAILABILITY	
		DATE	
		NO	
OPERATING SEQUENCE			
Bomblets ejected by explosive cartridge in nose of ejector.			
REMARKS			

~~SECRET~~

TABLE 24

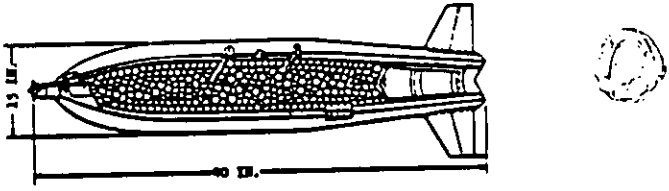
MUNITIONS DATA SHEET		DISPENSED MUNITIONS															
DESIGNATION MODEL CBU-23/B, 24/B, 35/B NAME Cluster Bomb SERVICE USAP MANUF. Aerojet, Honeywell		CATEGORY Air-to-Surface TARGETS Area targets Anti-personnel/ materiel															
		PHYSICAL CHARACTERISTICS LENGTH 39.0" DIAMETER 15.0" SPAN 30.0 WEIGHT 830W															
WEAPON CHARACTERISTICS WARHEAD 665-670 BLU-26/B Bomblet FILLER 139 # HE FUZING Timed or proximity airburst KILL MECH. Fragmentation LETHAL AREA		PERFORMANCE CHARACTERISTICS RANGE ALTITUDE FLIGHT TIME ACCURACY P _k (SINGLE SHOT) Remarks g/															
LAUNCH CHARACTERISTICS SUSPENSION 14" lugs DELIVERY MODE Dive, glide, level or toss RELEASE MODE Single, stick or salvo LIMITATIONS 650 Kts or Mach 1.2, 4 g's		USING AIRCRAFT F-100 (4) F-105 (7) F-4C (8) F-111 B-57 A-7A A-1E															
DISPENSER DATA MK31/B (CBU-23/B) MK30/B (CBU-24/B) MK39/B (CBU-29/B) Dispensers are various modifications of the MK5 Mod SADEYE Dispenser		FUZES MK339 (CBU-23/B) M907 (CBU-24/B) FMU-56/B (CBU-35/B) M219 (BLU-26/B) spin-armed, impact fuze															
		STATUS Inventory Presently rationed. Production scheduled to reach 8000/month by Feb 1968.															
		AVAILABILITY <table border="1"> <tr> <td>DAY</td> <td>1/67</td> <td>4/67</td> <td>1/68</td> <td>2/68</td> <td>1/68</td> <td>4/68</td> </tr> <tr> <td>NO</td> <td>3720</td> <td>1900</td> <td>1820</td> <td>2300</td> <td>2400</td> <td>12000</td> </tr> </table>		DAY	1/67	4/67	1/68	2/68	1/68	4/68	NO	3720	1900	1820	2300	2400	12000
DAY	1/67	4/67	1/68	2/68	1/68	4/68											
NO	3720	1900	1820	2300	2400	12000											
OPERATING SEQUENCE Cluster bomb splits longitudinally by the time fuze, allowing bomblets to free fall over a dispersed area. CBU-35/B has a radar altimeter fuzeing capability																	
REMARKS g/ Single Shot P _k (Estimated) <table border="1"> <thead> <tr> <th>Target</th> <th>Fractional Kill</th> </tr> </thead> <tbody> <tr> <td>Truck convoy (10'x98' ft)</td> <td>.187 - .257</td> </tr> <tr> <td>Personnel prone (16'x32)</td> <td>.520 - .714</td> </tr> <tr> <td>Personnel prone (98'x98')</td> <td>.312 - .541</td> </tr> <tr> <td>Personnel Standing (16'x32)</td> <td>.614 - .938</td> </tr> <tr> <td>Personnel Standing (98'x98')</td> <td>.383 - .733</td> </tr> </tbody> </table>				Target	Fractional Kill	Truck convoy (10'x98' ft)	.187 - .257	Personnel prone (16'x32)	.520 - .714	Personnel prone (98'x98')	.312 - .541	Personnel Standing (16'x32)	.614 - .938	Personnel Standing (98'x98')	.383 - .733		
Target	Fractional Kill																
Truck convoy (10'x98' ft)	.187 - .257																
Personnel prone (16'x32)	.520 - .714																
Personnel prone (98'x98')	.312 - .541																
Personnel Standing (16'x32)	.614 - .938																
Personnel Standing (98'x98')	.383 - .733																
																	

~~SECRET~~

EB-9x

Table 24 to
Annex B to
Appendix E

TABLE 25

MUNITIONS DATA SHEET		DISPENSED MUNITIONS																
DESIGNATION MODEL CBU-25/A NAME SERVICE USAF MANUF.		CATEGORY DISPENSED MUNITIONS TARGETS Anti-personnel Area targets																
		PHYSICAL CHARACTERISTICS LENGTH 81.31 in DIAMETER 9.38 in width SPAN 11.28 in height WEIGHT 50 lb (empty) 264 lb (loaded)																
WEAPON CHARACTERISTICS WARHEAD 132 BLU-24/B Jungle Bomblets FILLER FUZING Centrifugal delay KILL MECH. Fragmentation LETHAL AREA		PERFORMANCE CHARACTERISTICS RANGE ALTITUDE FLIGHT TIME ACCURACY P _r (SINGLE SHOT)																
LAUNCH CHARACTERISTICS SUSPENSION 14" lugs DELIVERY MODE Low level, high-speed RELEASE MODE Single or ripple LIMITATIONS Release option must be made before take-off 160-400 KIAS, above 100 ft, 4 g's		USING AIRCRAFT A-1E T-28 B-26 B-27																
DISPENSER DATA SUU-4/A is a triangular cluster of six 73" aluminum tubes. Each tube holds 22 BLU-24/B bomblets. Ejection accomplished by electrical ignition of cartridge which builds up gas pressure to move expelling piston.	FUZES	STATUS Development <table border="1"> <tr> <td colspan="5">AVAILABILITY</td> </tr> <tr> <td>DATE</td> <td></td> <td></td> <td></td> <td></td> </tr> <tr> <td>NO</td> <td></td> <td></td> <td></td> <td></td> </tr> </table>		AVAILABILITY					DATE					NO				
AVAILABILITY																		
DATE																		
NO																		
OPERATING SEQUENCE Single tube pattern 30' wide 100 long salvo pattern 50' wide 175' long.																		
REMARKS <div style="text-align: center;"> <p>SUU-4/A DISPENSER</p> <p>BLU-24/B</p> </div>																		

~~SECRET~~

TABLE 26

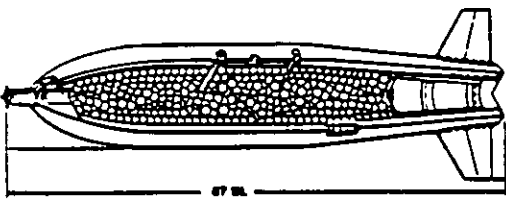
MUNITIONS DATA SHEET		DISPENSED MUNITIONS	
DESIGNATION MODEL MK15 Mod 0 (1) NAME TADPYE SERVICE (G) MANUF.		CATEGORY CLUSTER Air-to-Surface TARGETS Area targets Anti-personnel, material	PHYSICAL CHARACTERISTICS LENGTH DIAMETER SPAN WEIGHT
WEAPON CHARACTERISTICS WARHEAD M40 bomblets FILLER FUZING KILL MECH. LETHAL AREA		PERFORMANCE CHARACTERISTICS RANGE ALTITUDE FLIGHT TIME ACCURACY P _K (SINGLE SHOT)	
LAUNCH CHARACTERISTICS SUSPENSION 14" lugs DELIVERY MODE RELEASE MODE LIMITATIONS		USING AIRCRAFT	
DISPENSER DATA MK5 Mod 0, (planshell) dispenser	FUZES M907 mech time fuze opens cluster, can be set from 4 to 92 sec, 0.5 sec increments	STATUS AVAILABILITY DATE NO	
OPERATING SEQUENCE			
REMARKS 3. Versions available: MK15 Mod 0 M40 bomblet (HE) MK18 Mod 0 M40 dummy (practice) M319 Mod 0 M40 bomblet (fuze only) (exercise) MK21 Mod 0 M38 bomblet (HE) MK22 Mod 0 M30/M40 mixed			
			



~~SECRET~~

EB-9z

Table 26 to
Annex B to
Appendix E

~~SECRET~~

TABLE 27

MUNITIONS DATA SHEET		DISPENSED MUNITIONS	
DESIGNATION MODEL BLU-3/B, 15/B ^{a/} NAME SERVICE USAF MANUF.		CATEGORY Air-to-Surface Targets Area coverage Anti-materiel Anti-personnel	
		PHYSICAL CHARACTERISTICS LENGTH 3.75 in DIAMETER 2.75 in SPAN WEIGHT 1.73 lb	
WEAPON CHARACTERISTICS WARHEAD 4" Steel balls in aluminum matrix FILLER 170 grams RDX or CYCLOTOL FUZING Impact KILL MECH. Fragmentation, 250,4", 16 grain steel balls LETHAL AREA		PERFORMANCE CHARACTERISTICS RANGE ALTITUDE FLIGHT TIME ACCURACY Pk (SINGLE SHOT)	
LAUNCH CHARACTERISTICS SUSPENSION DELIVERY MODE Low level, high speed RELEASE MODE LIMITATIONS		USING AIRCRAFT	
DISPENSER DATA SUU-7B/A	FUZES	STATUS Inventory AVAILABILITY DATE NO	
OPERATING SEQUENCE			
REMARKS ^{a/} The BLU-15/B is an improved BLU-3/B			
 BLU-3/B Bomb 			

~~SECRET~~

EB-9aa

Table 27 to
Annex B to
Appendix E

TABLE 28

MUNITIONS DATA SHEET		DISPENSED MUNITIONS	
DESIGNATION MODEL BUU-4/A, 4A/F NAME SERVICE USAF MANUF.		CATEGORY <small>Roundlet</small> Air-to-surface TARGETS Area coverage Anti-personnel	
		PHYSICAL CHARACTERISTICS LENGTH 4.92" DIAMETER 2.78" SPAN WEIGHT 1.187#	
WEAPON CHARACTERISTICS (COPRAM ITEM) WARHEAD FILLER HE FUZING KILL MECH. Fragmentation LETHAL AREA		PERFORMANCE CHARACTERISTICS RANGE ALTITUDE FLIGHT TIME ACCURACY P _K (SINGLE SHOT)	
LAUNCH CHARACTERISTICS SUSPENSION DELIVERY MODE RELEASE MODE LIMITATIONS		USING AIRCRAFT	
DISPENSER DATA CBU-7/A (CBU-14/A) CBU-7A/A (CBU-14A/A)		FUZES	
		STATUS AVAILABILITY DATE NO	
OPERATING SEQUENCE			
REMARKS <div style="text-align: center;"> <p>STOWED WIND TAB DEPLOYED</p> </div>			

TABLE 29

MUNITIONS DATA SHEET		DISPENSED MUNITIONS																					
DESIGNATION MODEL FM-7A/B, 7A/B NAME SERVICE USAF MANUF.		CATEGORY Bomblet Air-to-surface TARGETS Area coverage Anti-tank																					
WEAPON CHARACTERISTICS WARHEAD Shaped charge FILLER FUZING Parachute armed, impact fuzed KILL MECH. Spalling and fragments LETHAL AREA		PHYSICAL CHARACTERISTICS LENGTH 7.86" DIAMETER 2.75" SPAN WEIGHT 1.32#																					
LAUNCH CHARACTERISTICS SUSPENSION CRU-3/A Munition, 14" lugs DELIVERY MODE High-speed, low level (50-150') RELEASE MODE 19 tube salvo LIMITATIONS 350 kts (min), 600 kts (max) or Mach 1.1		PERFORMANCE CHARACTERISTICS RANGE ALTITUDE FLIGHT TIME ACCURACY P _r (SINGLE SHOT)																					
DISPENSER DATA SIM-10/A Parachute		USING AIRCRAFT F-100 F-105 F-4C B-57 A-7A																					
FUZES		STATUS Inventory																					
		AVAILABILITY DATE <table border="1" style="display: inline-table; vertical-align: middle;"><tr><td> </td><td> </td><td> </td><td> </td><td> </td><td> </td><td> </td><td> </td><td> </td><td> </td></tr></table> NO <table border="1" style="display: inline-table; vertical-align: middle;"><tr><td> </td><td> </td><td> </td><td> </td><td> </td><td> </td><td> </td><td> </td><td> </td><td> </td></tr></table>																					
OPERATING SEQUENCE																							
REMARKS																							

~~SECRET~~

TABLE 30^F

MUNITIONS DATA SHEET		DISPENSED MUNITIONS	
DESIGNATION MODEL R11-13/A NAME SERVICE USAF MANUF.		CATEGORY Dispensed Bomblet TARGETS Air-to-Surface Area coverage	
WEAPON CHARACTERISTICS (COFRAM ITEM) WARHEAD FILLER FUZING KILL MECH. Fragmentation LETHAL AREA		PHYSICAL CHARACTERISTICS LENGTH 2.18" DIAMETER 2.16" (wide) SPAN 1.65" (thick) WEIGHT 0.48+16	
LAUNCH CHARACTERISTICS SUSPENSION 14" lugs, SSU-13/A Dispenser DELIVERY MODE RELEASE MODE LIMITATIONS		PERFORMANCE CHARACTERISTICS RANGE ALTITUDE FLIGHT TIME ACCURACY P _R (SINGLE SHOT)	
DISPENSER DATA SSU-13/A Dispenser carries 1200 R11-13/A units, in 40 downward ejection tubes each with a 30 unit package which breaks up on ejection and disperses.		USING AIRCRAFT	
FUZES		STATUS	
		AVAILABILITY	
		DATE	
		NO	
OPERATING SEQUENCE			
REMARKS			
			

~~SECRET~~

EB-9dd

Table 30 to
Annex B to
Appendix E

TABLE 31

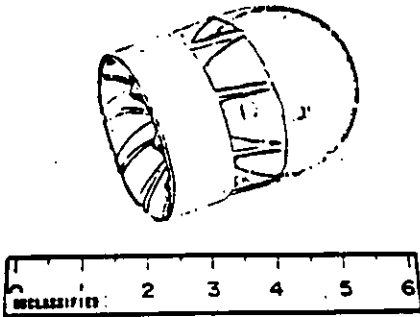
MUNITIONS DATA SHEET		DISPENSED MUNITIONS	
DESIGNATION MODEL BLU-24/B, 24A/B, 40/B NAME JUNGLE BOMB SERVICE MARK.		CATEGORY Air-Surface TARGETS Anti-personnel	
WEAPON CHARACTERISTICS WARHEAD Modular iron fragmenting case FILLER 0.26 lb H-6 FUZING Centrifugal KILL MECH. LETHAL AREA		PHYSICAL CHARACTERISTICS LENGTH 3.7 in DIAMETER 2.75 in SPAN 3.0 in stack height WEIGHT 1.6 lb	
LAUNCH CHARACTERISTICS SUSPENSION 14" SUU-14/A dispenser DELIVERY MODE RELEASE MODE Single, or ripple LIMITATIONS		PERFORMANCE CHARACTERISTICS RANGE ALTITUDE FLIGHT TIME ACCURACY P _K (SINGLE SHOT)	
DISPENSER DATA CBU-25/A (132 bomblets in SUU-14/A dispenser, 22 per each of six tubes)		FUZES Spin arm (after 1000"), spin decay detonation at 2000 rpm. The BLU-40/B has a long delay fuze.	
		STATUS Inventory and Development AVAILABILITY DATE NO	
OPERATING SEQUENCE			
REMARKS <div style="text-align: center;">  </div>			

~~SECRET~~

TABLE 32

MUNITIONS DATA SHEET		DISPENSED MUNITIONS	
DESIGNATION MODEL BLU-26/B, 41/B NAME SERVICE USAP MANUF. Honeywell		CATEGORY Air-Surface Anti-personnel/ material PHYSICAL CHARACTERISTICS LENGTH DIAMETER SPAN WEIGHT 0.934 lb	
WEAPON CHARACTERISTICS WARHEAD Steel balls in aluminum matrix FILLER FUZING Spin armed, impact detonating KILL MECH. Fragmentation LETHAL AREA 17.6' (standing troops), 10.6' (prome) 4.9' (trucks) penetrate 1/8" steel @ 20'		PERFORMANCE CHARACTERISTICS RANGE 27000 ft (max toss) ALTITUDE FLIGHT TIME ACCURACY P _g (SINGLE SHOT) Dud rate: 1 - 2%	
LAUNCH CHARACTERISTICS SUSPENSION CBU-23/B, 24/B, 35/B Munition, 14" lugs DELIVERY MODE Level, dive or toss RELEASE MODE Cluster LIMITATIONS		USING AIRCRAFT F-100 F-105 F-4C F-111 B-57 A-7A	
DISPENSER DATA SUU-30/B (CBU-24/B) SUU-31/B (CBU-23/B) SUU-39/B (CBU-35/B)		FUZES M-219 - Arming range 2400 to 3200 rpm, mechani- cally timed air burst fuze with black powder. Fuze set during preflight operations (4 to 92 sec) The BLU-41/B has a spin-arm decay detonate fuze.	
		STATUS AVAILABILITY DATE NO	
OPERATING SEQUENCE			
REMARKS			

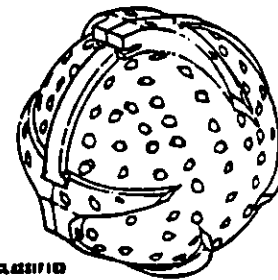

UNCLASSIFIED

~~SECRET~~

EB-9ff

Table 32 to
Annex B to
Appendix E

~~SECRET~~

TABLE 33

MUNITIONS DATA SHEET		DISPENSED MUNITIONS							
DESIGNATION MODEL NAME Anti-personnel grenade SERVICE MANUF.		CATEGORY Dispensed munition/Air-to-Surface TARGETS Area coverage Anti-personnel	PHYSICAL CHARACTERISTICS LENGTH Spherical DIAMETER 1.67" SPAN WEIGHT 0.287#						
WEAPON CHARACTERISTICS COFRAM WARHEAD FILLER FUZING KILL MECH. LETNAL AREA		PERFORMANCE CHARACTERISTICS RANGE ALTITUDE FLIGHT TIME ACCURACY PE (SINGLE SHOT)							
LAUNCH CHARACTERISTICS SUSPENSION DELIVERY MODE RELEASE MODE LIMITATIONS		USING AIRCRAFT							
DISPENSER DATA MKS Mod 0 with 2000 M40s designated CHU-101A	FUZES Impact	STATUS <table border="1"> <tr> <td colspan="2">AVAILABILITY</td> </tr> <tr> <td>DATE</td> <td></td> </tr> <tr> <td>NO</td> <td></td> </tr> </table>		AVAILABILITY		DATE		NO	
AVAILABILITY									
DATE									
NO									
OPERATING SEQUENCE									
REMARKS self-dispersing sphere									

~~SECRET~~

EB-9gg

Table 33 to
Annex B to
Appendix E

TABLE 34

MUNITIONS DATA SHEET		GUNS & PODS																	
DESIGNATION GUN POD MODEL SUU-11/A, 11A/A NAME MINIPOD SERVICE USAP MANUF.		CATEGORY Air-to-Surface TARGETS Personnel, light material	PHYSICAL CHARACTERISTICS LENGTH 85 in DIAMETER 12 in SPAR WEIGHT 325 lb (loaded) 245 lb (empty)																
WEAPON CHARACTERISTICS WARHEAD Ball, Tracers, AP FILLER FUZING None KILL MECH. Impact LETNAL AREA		PERFORMANCE CHARACTERISTICS RANGE ALTITUDE FLIGHT TIME ACCURACY 6 mile (80%) P_r (SINGLE SHOT)																	
LAUNCH CHARACTERISTICS SUSPENSION 14" lugs DELIVERY MODE Strafing, dive RELEASE MODE Burst LIMITATIONS Mach 1.2, 6 g's		USING AIRCRAFT A-1E T-28 B-26 AC-47																	
GUN DATA TYPE 6 barrel gatling gun 2750 fps muzzle velocity MODEL GAU-2/A, 2B/A BORE 7.62 mm RATE 6000 spm (max) a/ CAPACITY 1500 rds. electric drive b/	CARTRIDGES M59 Ball (Nato) M61 AP (Nato) M62 Tracer (Nato) M80 Ball (Nato)	STATUS Inventory Gas drive modification in development AVAILABILITY <table border="1"> <tr> <td>DATE</td> <td></td> <td></td> <td></td> <td></td> <td></td> <td></td> <td></td> </tr> <tr> <td>NO</td> <td></td> <td></td> <td></td> <td></td> <td></td> <td></td> <td></td> </tr> </table>		DATE								NO							
DATE																			
NO																			
OPERATING SEQUENCE																			
REMARKS a/ Usually fired at 2000 spm b/ Powered by Nicad battery in pod 																			

TABLE 35

MUNITIONS DATA SHEET		GUNS & PODS																					
DESIGNATION GUN POD MODEL SUU-12/A, 22/A NAME SERVICE USAP MANUF.		CATEGORY Air-to-Surface TARGETS Personnel, light materiel																					
WEAPON CHARACTERISTICS WARHEAD Ball, Tracers, AP, API FILLER FUZING KILL MECH. Impact LETHAL AREA		PHYSICAL CHARACTERISTICS LENGTH 118 in DIAMETER 16 in SPAN WEIGHT 465 lb (loaded) 240 lb (empty)																					
LAUNCH CHARACTERISTICS SUSPENSION 14" lugs DELIVERY MODE Dive, Strafing RELEASE MODE LIMITATIONS		PERFORMANCE CHARACTERISTICS RANGE ALTITUDE FLIGHT TIME ACCURACY P_R (SINGLE SHOT)																					
USING AIRCRAFT A-1E T-28 T-26		GUN DATA TYPE Single barrel NO. recoil, air cooled MODEL M3 BORE .50 cal RATE 1200 spm CAPACITY 750 rds																					
CARTRIDGES M2 Ball M2 AP M8 API M20 API		STATUS Inventory AVAILABILITY <table border="1"> <tr> <td>DATE</td> <td></td> <td></td> <td></td> <td></td> <td></td> <td></td> <td></td> <td></td> <td></td> </tr> <tr> <td>NO</td> <td></td> <td></td> <td></td> <td></td> <td></td> <td></td> <td></td> <td></td> <td></td> </tr> </table>		DATE										NO									
DATE																							
NO																							
OPERATING SEQUENCE																							
REMARKS <div style="text-align: center;"> </div>																							

~~SECRET~~

TABLE 36

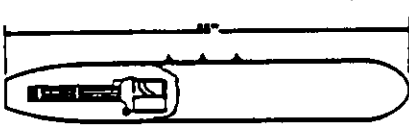
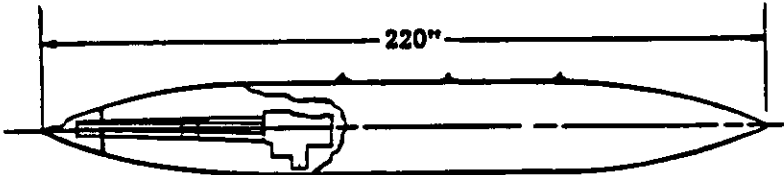
MUNITIONS DATA SHEET		GUNS & PODS													
DESIGNATION GUN POD MODEL SUU-16/A, 23/A NAME SERVICE USAF MANUF.		CATEGORY Air-to-Surface TARGETS Personnel, materiel													
		PHYSICAL CHARACTERISTICS LENGTH 200 in DIAMETER 22 in SPAN WEIGHT 1670 lb (loaded) 1000 lb (empty)													
WEAPON CHARACTERISTICS WARHEAD API, HEI, Ball FILLER FUZING Contact KILL MECH. Fragments, AP projectiles LETHAL AREA		PERFORMANCE CHARACTERISTICS RANGE 4500 ft ALTITUDE FLIGHT TIME ACCURACY 6-8 miles (80%) at 4500 ft P_K (SINGLE SHOT)													
LAUNCH CHARACTERISTICS SUSPENSOR 30" lugs DELIVERY MODE Dive RELEASE MODE LIMITATIONS Mach 1.2		USING AIRCRAFT F-100 F-105 F-8C/D F-111A A-7A													
GUN DATA TYPE 6 barrel gatling gun MODEL GAU-4/A BORE 20 mm RATE 6000 rpm a/ CAPACITY 1340 rds (SUU-16) 1200 rds (SUU-23)		CARTRIDGES M53 API M55 Ball (Practice) M56 HEI													
		STATUS Inventory SUU-23/A development under Task 250102 AVAILABILITY <table border="1"> <tr> <td>DATE</td> <td></td> <td></td> <td></td> <td></td> <td></td> </tr> <tr> <td>NO</td> <td></td> <td></td> <td></td> <td></td> <td></td> </tr> </table>		DATE						NO					
DATE															
NO															
OPERATING SEQUENCE															
REMARKS a/ The SUU-16/A is a ram air turbine drive. The SUU-23/A is a gas driven model of the SUU-16A 															

~~SECRET~~

EB-9jj

Table 36 to
Annex B to
Appendix E

TABLE 37

MUNITIONS DATA SHEET		GUNS & PODS	
DESIGNATION MODEL MK4 Gun Pod NAME SERVICE MANUF.		CATEGORY Air-to-Surface TARGETS Personnel, material	
		PHYSICAL CHARACTERISTICS LENGTH 197 in. DIAMETER SPAN WEIGHT 1350 lb	
WEAPON CHARACTERISTICS WARHEAD Ball, Tracers FILLER FUZING KILL MECH. LETNAL AREA		PERFORMANCE CHARACTERISTICS RANGE 3000 yds. (max) ALTITUDE FLIGHT TIME ACCURACY PK (SINGLE SHOT) Lt. Tank, .04 parked MIG, 31; Komar	
LAUNCH CHARACTERISTICS SUSPENSION DELIVERY MODE 10° dive, 450 ft, 450 kts. 2500-3000 ft. Slant range RELEASE MODE LIMITATIONS		USING AIRCRAFT	
GUN DATA TYPE Double barrel MD MODEL MK11 BORE 20 mm RATE 4200 rpm CAPACITY 750 rds		CARTRIDGES	
		STATUS Inventory AVAILABILITY DATE NO	
OPERATING SEQUENCE			
REMARKS <div style="text-align: center;"> </div>			

~~SECRET~~

TABLE 38

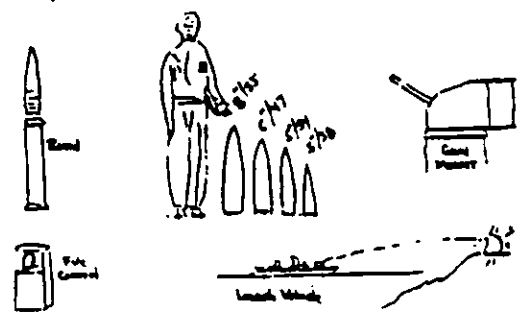
MUNITIONS DATA SHEET		GUNS & PODS
DESIGNATION GUN MOUNT MODEL 5"/38, 5"/54, 6"/47, 8"/55 NAME Naval Guns SERVICE USN MANUF.		CATEGORY Ship-to-Surface TARGETS Shore installations personnel & materiel, Anti- aircraft PHYSICAL CHARACTERISTICS LENGTH DIAMETER 5-8" bores SPAN WEIGHT 50-200 lbs
WEAPON CHARACTERISTICS WARHEAD HE & AP warheads FILLER FUZING Cont&et & Proximity fuzing RILL MECH. LETHAL AREA		PERFORMANCE CHARACTERISTICS 5"/38: 18000 yds 5"/54: 25900 yds 6"/47: 25200 yds 8"/55: 29000 yds ACCURACY: 0.5% deflection 0.07% Range
LAUNCH CHARACTERISTICS 5"/38 15-18 RPM/tube, Single & Twin Tubes 5"/54: 40 RPM/Tube, Automatic Single Tube 6"/47: 10+3 RPM/Tube, Triple Tube 8"/55: 3 RPM/Tube, Triple Tube		USING CRAFT 5"/38: DD 5"/54: DDG, DLD, CV 6"/47: CGO 8"/55: CA, CAO
GUN DATA TYPE MODEL BORE RATE CAPACITY	CARTRIDGES	STATUS Continuing production to meet in- ventory objectives. Overall world wide inventory is good. Availability of charge and projectiles for certain applications may be limited depending on usage rate. s/ AVAILABILITY DATE NO.
OPERATING SEQUENCE		
REMARKS s/ 5"/54 and 5"/38 RAP (Rocket assist projectiles) are planned for FY 69 and FY 70. RAP will extend ranges follows: 5"/38: 26000 yds, 5"/54: 24000 yds. 		

~~SECRET~~

EB-911

Table 38 to
Annex B to
Appendix E

TABLE 39





MUNITIONS DATA SHEET		ROCKETS																																										
DESIGNATION MODEL 2.75" FFAR NAME SERVICE USAF/USN/USMC MANUF.		CATEGORY Air-to-Surface, Air-to-Air TARGETS Personnel, vehicle, boats, tanks PHYSICAL CHARACTERISTICS LENGTH 48.5" DIAMETER 2.75" SPAN WEIGHT 18#																																										
WEAPON CHARACTERISTICS WARHEAD See Remarks g/ FILLER See Remarks g/ FUZING See Remarks g/ KILL MECH. Blast and frag LETAL AREA		PERFORMANCE CHARACTERISTICS RANGE 2000 - 6000' ALTITUDE FLIGHT TIME ACCURACY Pk (SINGLE SHOT) Remarks d/																																										
LAUNCH CHARACTERISTICS SUSPENSION 13" & 30" lugs (launcher) DELIVERY MODE 5-30° dive RELEASE MODE Single or ripple LIMITATIONS 600 kts		USING AIRCRAFT F-100 F-105 F-4C F-111 A-1E T-28 B-26 B-57 A-7A																																										
LAUNCHER DATA Designation Tubes LAU-3/A, 3A/A 19 LAU-18/A 19 LAU-32/A, 32A/A, 32B/A 7 LAU-49/A 7 LAU-49/A 7 See Remarks g/		PROPULSION TYPE Solid Propellant MODEL MK 2 THRUST 720# Motor is 2.75" dia x 39.62" Weight 11.32#																																										
		STATUS Inventory AVAILABILITY DATE NO																																										
OPERATING SEQUENCE Delivery tactics, 5-30° dive, release at 2500' altitude, 450 kts																																												
REMARKS g/ <table border="0"> <tr> <td>NAME</td> <td>HE</td> <td>HEAT</td> <td>HFAP</td> <td>FLECHETTE</td> <td rowspan="10"> s/ The LAU-3 weighs 431# loaded and is disposable. The LAU-18 is reusable. The LA-32/A weighs 175# loaded. </td> </tr> <tr> <td>Designation</td> <td>MK I Mod I</td> <td>MK 5 Mod O</td> <td>M151</td> <td>M101</td> </tr> <tr> <td>Filler</td> <td>1.4# HBX-1</td> <td>.89# Comp B</td> <td>2.5# Comp B</td> <td>Flechettes</td> </tr> <tr> <td>Fuzer</td> <td>MK 178</td> <td>MK 181</td> <td>M-27</td> <td>MK176</td> </tr> <tr> <td>Length</td> <td>Contact</td> <td>Contact</td> <td>Contact</td> <td>Burnout</td> </tr> <tr> <td>Weight</td> <td>11'</td> <td>11'</td> <td>11'</td> <td>18.54"</td> </tr> <tr> <td>Kill mech</td> <td>6.5 #</td> <td>6.5#</td> <td>9.5#</td> <td>9.3#</td> </tr> <tr> <td></td> <td>Blast and fragments</td> <td>Shaped charge</td> <td>Blast and fragments</td> <td>High energy impact</td> </tr> </table>				NAME	HE	HEAT	HFAP	FLECHETTE	s/ The LAU-3 weighs 431# loaded and is disposable. The LAU-18 is reusable. The LA-32/A weighs 175# loaded.	Designation	MK I Mod I	MK 5 Mod O	M151	M101	Filler	1.4# HBX-1	.89# Comp B	2.5# Comp B	Flechettes	Fuzer	MK 178	MK 181	M-27	MK176	Length	Contact	Contact	Contact	Burnout	Weight	11'	11'	11'	18.54"	Kill mech	6.5 #	6.5#	9.5#	9.3#		Blast and fragments	Shaped charge	Blast and fragments	High energy impact
NAME	HE	HEAT	HFAP	FLECHETTE	s/ The LAU-3 weighs 431# loaded and is disposable. The LAU-18 is reusable. The LA-32/A weighs 175# loaded.																																							
Designation	MK I Mod I	MK 5 Mod O	M151	M101																																								
Filler	1.4# HBX-1	.89# Comp B	2.5# Comp B	Flechettes																																								
Fuzer	MK 178	MK 181	M-27	MK176																																								
Length	Contact	Contact	Contact	Burnout																																								
Weight	11'	11'	11'	18.54"																																								
Kill mech	6.5 #	6.5#	9.5#	9.3#																																								
	Blast and fragments	Shaped charge	Blast and fragments	High energy impact																																								
d/ Estimated Single-Pass Pk <table border="0"> <tr> <td>1: Tank</td> <td>LAU-3A/A</td> <td>LAU-32A/A</td> </tr> <tr> <td>MG 19 (revetted)</td> <td>.03 (1 pod)</td> <td>.02 (2 pods)</td> </tr> <tr> <td>1.5 ton truck</td> <td>.01 (2 pods)</td> <td>.01 (5 pods)</td> </tr> <tr> <td>KOHAR Boat</td> <td>.01 (1 pod)</td> <td>.01 (3 pods)</td> </tr> <tr> <td>57mm gun</td> <td>.05 (1 pod)</td> <td>.02 (1 pod)</td> </tr> <tr> <td></td> <td>.01 (1 pod)</td> <td>.01 (1 pod)</td> </tr> </table>		1: Tank	LAU-3A/A	LAU-32A/A		MG 19 (revetted)	.03 (1 pod)	.02 (2 pods)		1.5 ton truck	.01 (2 pods)	.01 (5 pods)	KOHAR Boat	.01 (1 pod)	.01 (3 pods)	57mm gun	.05 (1 pod)	.02 (1 pod)		.01 (1 pod)	.01 (1 pod)																							
1: Tank	LAU-3A/A	LAU-32A/A																																										
MG 19 (revetted)	.03 (1 pod)	.02 (2 pods)																																										
1.5 ton truck	.01 (2 pods)	.01 (5 pods)																																										
KOHAR Boat	.01 (1 pod)	.01 (3 pods)																																										
57mm gun	.05 (1 pod)	.02 (1 pod)																																										
	.01 (1 pod)	.01 (1 pod)																																										
		 <p>2.75 FFAR</p>																																										

TABLE 40

MUNITIONS DATA SHEET		ROCKETS	
DESIGNATION MODEL 5.0" PPAR NAME ZUNI SERVICE USN MANUF.		CATEGORY Air-to-Surface TARGETS Anti-personnel/ materiel/tank	
WEAPON CHARACTERISTICS WARHEAD MK24 GP a/ MK32 ATAP b/ FILLER 9.5# Comp B 15.0# Comp B FUZING Contact, delay, proximity Contact, proximity KILL MECH. Fragmentation and Blast LETHAL AREA		PHYSICAL CHARACTERISTICS LENGTH GP a/ ATAP b/ 95" 107" DIAMETER 5" 5" SPAN WEIGHT 107#	
LAUNCH CHARACTERISTICS SUSPENSION 14" and 30" lugs DELIVERY MODE 5-30° dive RELEASE MODE single or ripple LIMITATIONS		PERFORMANCE CHARACTERISTICS RANGE ALTITUDE FLIGHT TIME ACCURACY P _r (SINGLE SHOT)	
LAUNCHER DATA LAU-10/A is a four tube aluminum launcher, reusable for approximately 25 firings. It is 97.6" long, 13.9" diameter and weighs 527# loaded.		USING AIRCRAFT A-1E T-28 B-26 F-100 F-105 F-4 F-111	
PROPULSION TYPE Solid propellant MODEL MK 16 Mod 1 THRUST		STATUS Inventory AVAILABILITY DATE NO.	
OPERATING SEQUENCE			
REMARKS a/ MK24 Mod 0 warhead, 17.05" long, is for general purpose anti-personnel/materiel. Uses the MK188, MK 191 Mod 0 of M414 fuzes. b/ MK32 Mod 0 warhead, 30.3" long, is for anti-tank/armor/anti-personnel. Uses the MK188 or M414 fuze.			

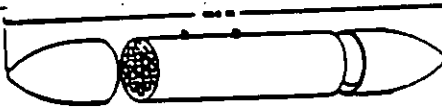
~~SECRET~~

TABLE 41

MUNITIONS DATA SHEET		GUIDED MISSILES													
DESIGNATION MODEL BULLPOUP B NAME AGM-12C, 12(E) ^{a/} ^{b/} SERVICE USAF/USN MANUF. Martin		CATEGORY Air-to-Surface TARGETS Point Tar- gets AAA/SAM Sites (AGM-12E)													
WEAPON CHARACTERISTICS WARHEAD MK 40 Mod 0, 975 lb FILLER 371 lb H6+Picratal FUZING MK 312 Mod 0, Mod 2 KILL MECH. Fragmentation & Blast LETHAL AREA		PHYSICAL CHARACTERISTICS LENGTH 13.36 ft DIAMETER 17.32 in SPAN 3.67 in WEIGHT 1778.5 lb (launch)													
LAUNCH CHARACTERISTICS SUSPENSION RAC PYLON, MAU-12B/A Rack ^{d/} DELIVERY MODE Shallow dive RELEASE MODE Single LIMITATIONS Mach 0.95 launch, 5-65° dive angle, visual indent. of target		PERFORMANCE CHARACTERISTICS RANGE 60000 ft (max) 10000 ft (min) ALTITUDE 40000 ft (max) FLIGHT TIME 8-30 sec Speed Mach 2.5 ACCURACY 30 ft CEP/15000' SR P _r (SINGLE SHOT) ^{e/}													
GUIDANCE PRELAUNCH None BOOST Unguided, control surfaces held neutral MIDCOURSE Radio command TERMINAL Radio command maneuverability limited to 2 g's at impact		PROPULSION TYPE Storable Liquid Rocket MODEL LR 62-RM-4 THRUST 30000 lb/2.3 sec OXIDIZER: IRFNB (348.4 lb) FUEL: MAF-1													
		STATUS INVENTORY/DEVELOPMENT Operational Oct 1965 AVAILABILITY <table border="1"> <tr> <th>DATE</th> <th>Mar65</th> <th>Apr65</th> <th>Jun67</th> <th>Jul67</th> <th>Aug67</th> </tr> <tr> <th>NO.</th> <td>165</td> <td>525</td> <td>525</td> <td>525</td> <td>525</td> </tr> </table>		DATE	Mar65	Apr65	Jun67	Jul67	Aug67	NO.	165	525	525	525	525
DATE	Mar65	Apr65	Jun67	Jul67	Aug67										
NO.	165	525	525	525	525										
OPERATING SEQUENCE Pilot visually acquires target, initiates a dive toward target area and launches missile. Flight path tracked visually (flashes on missile rear) VHF radio link used to correct flight path. Pilot initiates a 3.5 g pull-out at impact.															
REMARKS ^{a/} AGM-12C was formerly AEM-N-7b. ^{b/} The AGM-12E is a development to replace the AGM-12C warhead with a cluster warhead containing 810 BLU-26/B bomblets with MK 312 radar altitude fuzing. ^{c/} 2 mil accuracy for slant range 15000 ft. ^{d/} Requires 5 mins for 3 men to hang missile and check out aircraft/missile system.															
 <p>AGM-12C</p>  <p>AGM-12E</p>															

~~SECRET~~

EB-900

Table 41 to
Annex B to
Appendix E

TABLE 42

MUNITIONS DATA SHEET		GUIDED MISSILES																																																																							
DESIGNATION MODEL AGM-45A NAME SHRIKE SERVICE US NAVY MANUF. Texas Instrument		CATEGORY MISSILE Air-to-surface TARGETS S-Band, C-Band radar transmitters LENGTH 127 in DIAMETER 8.0 in SPAN 36.25"(body) 18"(tail) WEIGHT 395.4 lb																																																																							
WEAPON CHARACTERISTICS WARHEAD 141 lb Frng (22000 3/16" steel cubes) FILLER 51 lb PRXM-101 FUZING VT, contact KILL MECH. Fragmentation LETHAL AREA		PERFORMANCE CHARACTERISTICS RANGE 27NM (max) 4NM (min) ALTITUDE 6000' (min-dive) FLIGHT TIME ACCURACY 21 ft CEP P_k (SINGLE SHOT) 0.45 Est ^{2/} 0.28 Est ^{3/}																																																																							
LAUNCH CHARACTERISTICS SUSPENSION Hanger lugs, short rail DELIVERY MODE Loft, dive, level, or pitch-up RELEASE MODE Single or ripple release LIMITATIONS		USING AIRCRAFT A-4 A-7 A-6 F-4B F-4C F-4D F-105																																																																							
GUIDANCE PRELAUNCH BOOST MIDCOURSE Ballistic TERMINAL Passive Radar Homing		PROPULSION TYPE MODEL THRUST 22,200 lb-sec																																																																							
		STATUS DEVELOPMENT L & X-Band seekers in development. VHF Seeker under study. Firm production contract for 350/mo (FY 67). New Auth 850/mo; Plan 550/mo (Jun 67)																																																																							
		AVAILABILITY <table border="1"> <tr> <td>DATE</td> <td>FY67</td> <td>1st</td> <td></td> <td></td> <td></td> </tr> <tr> <td>NO.</td> <td>5058</td> <td></td> <td></td> <td></td> <td></td> </tr> </table>		DATE	FY67	1st				NO.	5058																																																														
DATE	FY67	1st																																																																							
NO.	5058																																																																								
OPERATING SEQUENCE The missile radar provides the pilot data on existence and location of the radar transmitter.																																																																									
REMARKS a/ Appropriate head must be installed prior to mission. b/ Original estimate. c/ Estimate from tests. d/ Hq USAF production estimate. The Joint Chiefs of Staff, in JCS 1725/613-5, dtd 7 Mar 67, recommended the following production of SHRIKE (also see entry for STANDARD ARM, page _____): <table border="1" style="margin-top: 10px;"> <thead> <tr> <th colspan="4">SHRIKE REQUIREMENTS</th> </tr> </thead> <tbody> <tr> <td>1967</td> <td>Sep</td> <td>550</td> <td>Sep</td> <td>520-(80)</td> </tr> <tr> <td></td> <td>Oct</td> <td>600</td> <td>Oct</td> <td>475-(125)</td> </tr> <tr> <td></td> <td>Nov</td> <td>600</td> <td>Nov</td> <td>450-(150)</td> </tr> <tr> <td></td> <td></td> <td></td> <td>Dec</td> <td>425-(175)</td> </tr> <tr> <td></td> <td>Dec</td> <td>600</td> <td></td> <td></td> </tr> <tr> <td>1968</td> <td>Jan</td> <td>600</td> <td>1969</td> <td>Jan</td> <td>400-(200)</td> </tr> <tr> <td></td> <td>Feb</td> <td>600</td> <td>Feb</td> <td>375-(225)</td> </tr> <tr> <td></td> <td>Mar</td> <td>600</td> <td>Mar</td> <td>350-(250)</td> </tr> <tr> <td></td> <td>Apr</td> <td>600</td> <td>Apr</td> <td>8,320 (1,280) a/</td> </tr> <tr> <td></td> <td>May</td> <td>600</td> <td>May</td> <td>End of</td> </tr> <tr> <td></td> <td>Jun</td> <td>600</td> <td>Jun</td> <td>FY 68</td> </tr> <tr> <td></td> <td>Jul</td> <td>575-(25)</td> <td></td> <td>Procurement</td> </tr> <tr> <td></td> <td>Aug</td> <td>550-(50)</td> <td></td> <td></td> </tr> </tbody> </table> e/ The Joint Chiefs of Staff, in message JCS 1725/613-5, recommend deleting this number of SHRIKE's in favor of an equal number (1,280) of STANDARD ARM's (Mod 1), if subsequent tests on the Mod 1 are successful.				SHRIKE REQUIREMENTS				1967	Sep	550	Sep	520-(80)		Oct	600	Oct	475-(125)		Nov	600	Nov	450-(150)				Dec	425-(175)		Dec	600			1968	Jan	600	1969	Jan	400-(200)		Feb	600	Feb	375-(225)		Mar	600	Mar	350-(250)		Apr	600	Apr	8,320 (1,280) a/		May	600	May	End of		Jun	600	Jun	FY 68		Jul	575-(25)		Procurement		Aug	550-(50)		
SHRIKE REQUIREMENTS																																																																									
1967	Sep	550	Sep	520-(80)																																																																					
	Oct	600	Oct	475-(125)																																																																					
	Nov	600	Nov	450-(150)																																																																					
			Dec	425-(175)																																																																					
	Dec	600																																																																							
1968	Jan	600	1969	Jan	400-(200)																																																																				
	Feb	600	Feb	375-(225)																																																																					
	Mar	600	Mar	350-(250)																																																																					
	Apr	600	Apr	8,320 (1,280) a/																																																																					
	May	600	May	End of																																																																					
	Jun	600	Jun	FY 68																																																																					
	Jul	575-(25)		Procurement																																																																					
	Aug	550-(50)																																																																							



TABLE 43

MUNITIONS DATA SHEET		GUIDED MISSILES															
DESIGNATION		CATEGORY GLIDE BOMB	PHYSICAL CHARACTERISTICS														
MODEL	AGM-62A	Air-to-Surface	LENGTH 136 in														
NAME	WALLEYE	TARGETS Large semi-hard, such as air-bases, bridges & ships	DIAMETER 15.0 in														
SERVICE	US NAVY		SPAN 45.0 in														
MANUF.	MARTIN		WEIGHT 1,125 lb														
WEAPON CHARACTERISTICS		PERFORMANCE CHARACTERISTICS															
WARHEAD	Linear shaped charge, 825 lb	RANGE	25 NM max; 0.5 NM min														
FILLER	450 lb COMP B	ALTITUDE	50,000' max														
FUZING	Contact or delay	FLIGHT TIME															
KILL MECH.	Blast	ACCURACY	15 ft CEP														
LETHAL AREA		P_K (SINGLE SHOT) a/															
LAUNCH CHARACTERISTICS		USING AIRCRAFT															
SUSPENSION	14" & 30" lugs	A-6A															
DELIVERY MODE	Dive (15-45°) Low-level	A-4E/T															
RELEASE MODE	Single	A-7A															
LIMITATIONS	Mach .95 max, Mach 0.5 min	F-4D															
	158,000' SR at 50,000' altitude	F-111															
	7,000' SR minimum																
GUIDANCE	PROPULSION	STATUS PRODUCTION:															
PRELAUNCH	TV guidance sys for target acquisition	None, free-fall bomb															
BOOST		QUALIFICATION Completed Dec 66															
MIDCOURSE		PRODUCTION NAFI # 16/mn Martin contract for 201 USN, 190 USAF FY 66															
TERMINAL	Self-contained edge contrast TV tracking system	AVAILABILITY															
		<table border="1"> <thead> <tr> <th>DATE</th> <th>FY67</th> <th>FY68</th> <th>FY69</th> <th></th> <th></th> <th></th> </tr> </thead> <tbody> <tr> <td>NO</td> <td>404</td> <td>447</td> <td>714</td> <td></td> <td></td> <td></td> </tr> </tbody> </table>		DATE	FY67	FY68	FY69				NO	404	447	714			
DATE	FY67	FY68	FY69														
NO	404	447	714														
OPERATING SEQUENCE																	
Target is visually acquired by pilot; after lock-on, pilot releases weapon and is free to break away. Glide ratio is 3.5 to 1. TV system tracks target edge to provide control signals for target homing.																	
REMARKS																	
a/ Single Pass P _K Est 0.85 Komer Boat 0.79 POL Tank 0.79 Radar Van/Ant 0.78 1.5 Ton Truck 0.64 Light Tank 0.11 Cinder Bridge 0.03 Barrack Area																	

TABLE 44

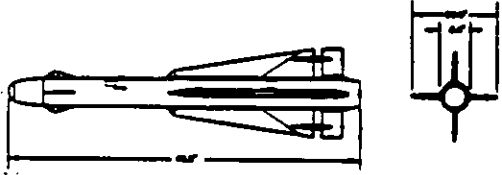
MUNITIONS DATA SHEET		GUIDED MISSILES														
DESIGNATION MODEL AIM-4D ^{a/} NAME FALCON SERVICE USAP MANUF. HUGHES (Model FPC)		CATEGORY Air-to-air TARGETS Aircraft PHYSICAL CHARACTERISTICS LENGTH 79.2 in DIAMETER 6.5 in SPAN 20 in WEIGHT 134 lb														
WEAPON CHARACTERISTICS WARHEAD FILLER 2.75 lb HBX FUZING Contact KILL MECH. Blast LETHAL AREA Hit to kill		PERFORMANCE CHARACTERISTICS RANGE 3-5NM ALTITUDE 65000 ft FLIGHT TIME ACCURACY P _k (SINGLE SHOT) 0.92														
LAUNCH CHARACTERISTICS SUSPENSION Rail launch DELIVERY MODE Lead collision or pursuit RELEASE MODE Single, paired, or tripled LIMITATIONS 3500-35000 ft range		USING AIRCRAFT F-101 F-102 F-111 F-4D F-4E														
GUIDANCE PRELAUNCH Radar Slaving and IR self-track 800ST MIDCOURSE TERMINAL Long wave IR homing Proportional navigation	PROPULSION TYPE Solid rocket, single level MODEL M58A2 THRUST 4220 lb/1.4 sec	STATUS INVENTORY ^{b/} To be deployed to SEA on F-4D, Jul 67 AVAILABILITY <table border="1"> <tr> <td>DATE</td> <td>1965</td> <td>1966</td> <td>1967</td> <td></td> <td></td> <td></td> </tr> <tr> <td>NO.</td> <td>1300</td> <td>3000</td> <td>4200</td> <td></td> <td></td> <td></td> </tr> </table>	DATE	1965	1966	1967				NO.	1300	3000	4200			
DATE	1965	1966	1967													
NO.	1300	3000	4200													
OPERATING SEQUENCE IR detector acquires the target prior to launch and maintains lock during launch sequence. Launch sequence requires approximately 1 sec. Launch can be made in pure pursuit or lead pursuit. Proportional navigation guidance used in flight.																
REMARKS ^{a/} Formerly GAR-2B ^{b/} Inventory AIM-4B and AIM-4C missiles are being updated to the 4D configuration.																
																

~~SECRET~~

TABLE 45

MUNITIONS DATA SHEET		GUIDED MISSILES													
DESIGNATION		CATEGORY	PHYSICAL CHARACTERISTICS												
MODEL	A1M-47 A/	Air-to-air TARGETS Aircraft	LENGTH 86.37 in												
NAME	FALCON		DIAMETER 6.64 in												
SERVICE	USAF		SPAN 24.0 in												
MANUF.	HUGHES (Model EPb)		WEIGHT 152 lb												
WEAPON CHARACTERISTICS		PERFORMANCE CHARACTERISTICS													
WARHEAD		RANGE													
FILLER	5 lb HBX	ALTITUDE													
FUZING	Contact	FLIGHT TIME													
KILL MECN.	Blast	ACCURACY													
LETHAL AREA	Hit-to-kill	P _K (SINGLE SHOT)													
LAUNCH CHARACTERISTICS		USING AIRCRAFT													
SUSPENSION	Rail launch	F-106													
DELIVERY MODE	Lead Collision														
RELEASE MODE	Salvo of 2 or 4														
LIMITATIONS															
GUIDANCE	PROPULSION	STATUS INVENTORY													
PRELAUNCH	Tracking only	<table border="1"> <tr><td colspan="4">AVAILABILITY</td></tr> <tr><td>DATE</td><td></td><td></td><td></td></tr> <tr><td>NO.</td><td></td><td></td><td></td></tr> </table>		AVAILABILITY				DATE				NO.			
AVAILABILITY															
DATE															
NO.															
BOOST	Tracking only														
MIDCOURSE	Semi-active X-band pulse radar homing														
TERMINAL	Semi-active X-band pulse radar homing proportional navigation														
	TYPE Solid rocket, two level														
	MODEL M 46														
	THRUST High: 4420 lb/0.63 sec Low: 635 lb/4.09 sec														
OPERATING SEQUENCE															
REMARKS															
A/ Formerly GAR-3A															
															

~~SECRET~~

EB-9ss

Table 45 to
Annex B to
Appendix E

~~SECRET~~

TABLE 46

MUNITIONS DATA SHEET		GUIDED MISSILES												
DESIGNATION MODEL AIM-4G ^{g/} NAME FALCON SERVICE USAF MANUF. Hughes (Model GPb)		CATEGORY Air-to-air TARGETS Aircraft												
		PHYSICAL CHARACTERISTICS LENGTH 82.5 in DIAMETER 6.64 in SPAN 24.0 in WEIGHT 146 lb (launch)												
WEAPON CHARACTERISTICS WARHEAD Blast (8 lb) FILLER 5 lb HBX-3 FUZING Contact, stabilizer leading edge KILL MECH Blast LETHAL AREA Hit-to-kill		PERFORMANCE CHARACTERISTICS RANGE 35000 ft (max) 1000 ft (min) ALTITUDE 70000 ft FLIGHT TIME 1.3-22.0 sec ACCURACY P _r (SINGLE SHOT) .87 for salvo of 2, rear hemisphere attack												
LAUNCH CHARACTERISTICS SUSPENSION Rail launch DELIVERY MODE Lead collision RELEASE MODE Salvo of 2 or 4 LIMITATIONS		USING AIRCRAFT F-106A (6)												
GUIDANCE PRELAUNCH Tracking only lock-on, 16 sec min BOOST Tracking only MIDCOURSE Passive IR homing TERMINAL Passive IR homing	PROPULSION TYPE Solid rocket, two level MODEL M-6 THRUST High: 4420 lb/0.63 sec Low: 635 lb/4.09 sec.	STATUS INVENTORY Production completed 1962 AVAILABILITY DATE <table border="1"><tr><td> </td><td> </td><td> </td><td> </td><td> </td><td> </td></tr></table> NO <table border="1"><tr><td> </td><td> </td><td> </td><td> </td><td> </td><td> </td></tr></table>												
OPERATING SEQUENCE														
REMARKS ^{g/} Formerly GAR-4A <div style="text-align: center;">  </div>														

~~SECRET~~

EB-9tt

Table 46 to
Annex B to
Appendix E

~~SECRET~~

TABLE 47

MUNITIONS DATA SHEET		GUIDED MISSILES							
DESIGNATION		CATEGORY Air-to-air TARGETS Aircraft	PHYSICAL CHARACTERISTICS						
MODEL	AIM-7D, 7E, 7F		LENGTH	144.5 in					
NAME	Sparrow III A,B,C		DIAMETER	8 in					
SERVICE	USN		SPAN	40 in					
MANUF.	RAYTHEON		WEIGHT	440 lb (AIM-7D) 450 lb (AIM-7E, 7F)					
WEAPON CHARACTERISTICS		PERFORMANCE CHARACTERISTICS							
WARHEAD	(AIM-7D,7E) 28' Contin Rod	(AIM-7F) 40' Contin Rod	RANGE	AIM-7D 8.5 NM	AIM-7E 13.5 NM	AIM-7F 25 NM			
FILLER	17.9 lb DATB		ALTITUDE	70000'	90000'	90000'			
FUSING	Proximity and impact		FLIGHT TIME						
KILL MECH.			Speed, Mach	3.5	4.2	5.1			
LETHAL AREA			ACCURACY						
LAUNCH CHARACTERISTICS		USING AIRCRAFT							
SUSPENSION			F-4B						
DELIVERY MODE			F-4C						
RELEASE MODE	Single, ripple		F-4D						
LIMITATIONS	Mach 2.5		F-4J						
		F-3C							
GUIDANCE	PROPULSION	STATUS INVENTORY/DEVEL.							
PRELAUNCH	Pulse radar		Development - NTE 2Q FY68						
BOOST	TYPE Solid Propellant Rocket		Qualification - PPST 3Q FY68						
MIDCOURSE	Semi-active CW radar homing		OPERVAL 1Q FY69						
TERMINAL	Semi-active CW radar homing		Inventory plan-AIM-7D,7E,7F						
		MODEL		AVAILABILITY					
		THRUST		DATE	FY67	FY68	FY69	FY70	FY71
				NO.	7436	6548	6156	5260	4176
OPERATING SEQUENCE									
Boost Glide missile									
REMARKS									
<p>A technical drawing of the Sparrow III missile in profile, facing left. A dimension line above the missile indicates a total length of 144.5 inches. The drawing shows the nose cone, the main body, and the tail section with four fins. A small circular detail is shown to the right of the tail section.</p>									

~~SECRET~~

EB-9uu

Table 47 to
Annex B to
Appendix E

TABLE 48

MUNITIONS DATA SHEET		GUIDED MISSILES	
DESIGNATION MODEL AIM-9B ^{a/} NAME SIDEWINDER IA SERVICE USN/USAF MANUF. MOTOROLA		CATEGORY Air-to-air TARGETS Aircraft	
		PHYSICAL CHARACTERISTICS LENGTH 111.5 in DIAMETER 5.0 in SPAN 22" (Wing), 15" (Fin) WEIGHT 164 lb	
WEAPON CHARACTERISTICS WARHEAD Frag FILLER 12.5 lb HBX-1 FUZING Impact and proximity (30') KILL MECH. Fragmentation and blast LETHAL AREA		PERFORMANCE CHARACTERISTICS RANGE 6NM ^{b/} ALTITUDE 65000' FLIGHT TIME ACCURACY Pk (SINGLE SHOT) 0.5	
LAUNCH CHARACTERISTICS SUSPENSION Lugs for shorttrail DELIVERY MODE Tailcone attack (1) RELEASE MODE Single, ripple LIMITATIONS 3 g's		USING AIRCRAFT F-4B A-7A F-104C (2) F-4J F-4C F-104D (2) A-6A F-4D F-104G (2) EA-6A F-105B F-100D (2) F-8D F-104A (2) F-100F F-8E FO104B (2)	
GUIDANCE PRELAUNCH BOOST MIDCOURSE TERMINAL IR Homing	PROPULSION TYPE Solid Rocket, single level MODEL MK 17 Mod 1 THRUST 3860 lb/2.2 sec Weight of motor: 41.0 lb	STATUS INVENTORY Planned inventory below: AVAILABILITY DATE FY67 FY68 FY69 FY70 FY71 NO. 4249 2899 11897 11543	
OPERATING SEQUENCE Passive infra-red seeker which collects signals and directs reticle chopped rays to a lead sulfide cell. Voltage variations of the cell are oriented by combination with phase generator signals. The resultant combined signal is fed to a control unit.			
REMARKS ^{a/} Formerly GAR-8, AAM-N-7 ^{b/} 6000' max range at MSL, 35000' max range at 50000' alt.			

~~SECRET~~

TABLE 49

MUNITIONS DATA SHEET		GUIDED MISSILES													
DESIGNATION MODEL AIM-9C NAME SIDEWINDER IC-SAR SERVICE USN MANUF. MOTOROLA		CATEGORY Air-to-air TARGETS Aircraft													
		PHYSICAL CHARACTERISTICS LENGTH 113 in DIAMETER 5 in SPAN 16.4 in WEIGHT													
WEAPON CHARACTERISTICS WARHEAD Mk 24 Continuous Rod FILLER 12.5 lb HBX-1 FUZING Impact and proximity (30') KILL MECH. Fragmentation LETHAL AREA		PERFORMANCE CHARACTERISTICS RANGE 9 NM ALTITUDE 80000' FLIGHT TIME ACCURACY P _r (SINGLE SHOT) 0.5													
LAUNCH CHARACTERISTICS SUSPENSION Lugs for short rail DELIVERY MODE RELEASE MODE Single LIMITATIONS Mach 1.8		USING AIRCRAFT F-4B A-7A F-4D F-111A/B F-8D F-8E A-6A EA-6A													
GUIDANCE PRELAUNCH BOOST MIDCOURSE Semi active radar seeker or home-on-jam TERMINAL Semi active radar seeker or home-on-jam		PROPULSION TYPE Solid Rocket MODEL THRUST													
		STATUS INVENTORY Planned inventory below: AVAILABILITY <table border="1"> <tr> <td>DATE</td> <td>FY67</td> <td>FY68</td> <td>FY69</td> <td>FY70</td> <td>FY71</td> </tr> <tr> <td>NO</td> <td>1179</td> <td>368</td> <td>1202</td> <td>3496</td> <td>2677</td> </tr> </table>		DATE	FY67	FY68	FY69	FY70	FY71	NO	1179	368	1202	3496	2677
DATE	FY67	FY68	FY69	FY70	FY71										
NO	1179	368	1202	3496	2677										
OPERATING SEQUENCE															
REMARKS															

~~SECRET~~

EB-9ww

Table 49 to
Annex B to
Appendix E

~~SECRET~~

TABLE 50

MUNITIONS DATA SHEET		GUIDED MISSILES																		
DESIGNATION MODEL AIM-9D <input checked="" type="checkbox"/> NAME SIDEWINDER IC-IR SERVICE USN MANUF. MOTOROLA		CATEGORY Air-to-air TARGETS Aircraft																		
PHYSICAL CHARACTERISTICS LENGTH 119 in DIAMETER 5 in SPAN 19.2 in WEIGHT																				
WEAPON CHARACTERISTICS WARHEAD Mk 24 Continuous Rod FILLER 12.5 lb HBX-1 <input checked="" type="checkbox"/> FUZING Impact and proximity (30') KILL MECH. Fragmentation LETHAL AREA		PERFORMANCE CHARACTERISTICS RANGE 9 NM ALTITUDE 80000' FLIGHT TIME ACCURACY Pk (SINGLE SHOT) 0.65																		
LAUNCH CHARACTERISTICS SUSPENSION Lugs for short rail DELIVERY MODE RELEASE MODE Single, ripple LIMITATIONS Mach 1.8		USING AIRCRAFT F-8D A-7A F-8E F-111 F-100 F-104 F-105 F-4C																		
GUIDANCE PRELAUNCH BOOST MIDCOURSE IR Homing TERMINAL IR Homing	PROPULSION TYPE MODEL THRUST	STATUS INVENTORY Planned inventory below: <table border="1"> <tr> <td colspan="6">AVAILABILITY</td> </tr> <tr> <td>DATE</td> <td>FY67</td> <td>FY68</td> <td>FY69</td> <td>FY70</td> <td>FY71</td> </tr> <tr> <td>NO</td> <td>914</td> <td>1057</td> <td>893</td> <td>789</td> <td>673</td> </tr> </table>	AVAILABILITY						DATE	FY67	FY68	FY69	FY70	FY71	NO	914	1057	893	789	673
AVAILABILITY																				
DATE	FY67	FY68	FY69	FY70	FY71															
NO	914	1057	893	789	673															
OPERATING SEQUENCE																				
REMARKS <input checked="" type="checkbox"/> The AIM-9D is an improved version of the AIM-9B with better guidance and control capability and improved propulsion unit which gives it a better high altitude capability against maneuvering targets. <input checked="" type="checkbox"/> Two blast - fragmentation warheads under development. NOTES Model 214 (10 lb PBX, 3/8" steel cubes) NOTES Model 214A (10 lb PBX, 3/16" steel cubes)																				

~~SECRET~~

EB-9xx

Table 50 to
Annex B to
Appendix E

TABLE 51

MUNITIONS DATA SHEET		GUIDED MISSILES		
DESIGNATION		CATEGORY Air-to-air TARGETS Aircraft	PHYSICAL CHARACTERISTICS	
MODEL	AIM-26B (1) (2)		LENGTH	85 in
NAME	FALCON		DIAMETER	11.4 in
SERVICE	USAF		SPAN	24.5 in
MANUF.	Hughes (Model 52a)		WEIGHT	
WEAPON CHARACTERISTICS		PERFORMANCE CHARACTERISTICS		
WARHEAD	Continuous rod	RANGE		
FILLER	HE	ALTITUDE		
FUZING	Radar active FM-CW fuse	FLIGHT TIME		
KILL MECH.	Fragmentation	ACCURACY		
LETHAL AREA	30 ft	P_K	(SINGLE SHOT)	
LAUNCH CHARACTERISTICS		USING AIRCRAFT		
SUSPENSION		F-102A		
DELIVERY MODE	Lead collision			
RELEASE MODE				
LIMITATIONS				
GUIDANCE	PROPULSION	STATUS INVENTORY		
PRELAUNCH		Development - Feb 1962		
BOOST	Tracking only	Qualification - Operational Sep 62		
MIDCOURSE	Semi-active, X-Band pulse radar homing	Production - Aug 62 - Dec 63		
TERMINAL	Semi-active, X-Band pulse radar homing			
	Proportional navigation			
	TYPE Solid rocket, single level	AVAILABILITY		
	MODEL N60 Thicokl	DATE Inven		
	THRUST 5260 lb/2.09 sec	NO. 872		
	12880 lb-sec impulse			
	isp=215 lb-sec/lb			
OPERATING SEQUENCE				
REMARKS				
(1) Formerly GAR-11A				
(2) Same as AIM-26A except for warhead				
				

TABLE 52

MUNITIONS DATA SHEET		GUIDED MISSILES			
DESIGNATION		CATEGORY	PHYSICAL CHARACTERISTICS		
MODEL	RIM-2 Series	MISSILE Surface to air	RIM-2C	RIM-2D	RIM-2P
NAME	TERRIER	Aircraft Missiles	LENGTH	155"	174"
SERVICE			DIAMETER	13.5"	13.5"
MANUF.	General Dynamics/Pomona		SPAN PIN	23"	23"
			TAIL SPAN	42.6"	42.6"
			WEIGHT		
WEAPON CHARACTERISTICS		PERFORMANCE CHARACTERISTICS			
WARHEAD	RIM-2C HE Frag RIM-2D Nuclear RIM-2P HE Cont Rod	RANGE (MAX)	RIM-2C 20NM	RIM-2D 20NM	RIM-2P 40NM
FILLER		(MIN)	6500 yd	7500 yd	8000 yd
FUZION	Influence on all three types	ALTITUDE (MAX)	80,000'	80,000'	80,000'
KILL MECH.		(MIN)	1.5" above surface	Same	50 feet
LETHAL AREA		FLIGHT TIME			
		ACCURACY			
		P _K (SINGLE SHOT)	0.6		
LAUNCH CHARACTERISTICS		USING CRAFT			
SUSPENSION		Frigates			
DELIVERY MODE		Cruisers			
RELEASE MODE		Aircraft Carriers			
LIMITATIONS					
GUIDANCE		PROPULSION		STATUS	
PRELAUNCH		Solid propellant booster and sustainer		INVENTORY g/	
BOOST	Wing control to capture	MODEL		Current HT missile in use will be followed by SM (EM) production below	
MIDCOURSE	Beam riding pulsed C-Band radar	THRUST		AVAILABILITY	
TERMINAL	Beam riding pulsed C-Band radar or X-Band CW semi-active homing (RIM-2P)			DATE FY67 FY68 FY69 FY70 FY71 FY72	
				NO 580 660 660 630 600 450	
OPERATING SEQUENCE					
HT-3 Missiles are launched, captured, and guided by C-Band guidance to intercept					
HT-3 Missiles are launched into X-Band CW intercept beam and home on the energy reflected from the target					
REMARKS					
g/ Approximately 1,000 HT-3 missiles are in RFI condition which is about 1/3 of the approved OSD inventory but only 1/6 of the USN inventory objective.					

TABLE 53

MUNITIONS DATA SHEET		GUIDED MISSILES	
DESIGNATION		CATEGORY MISSILE	PHYSICAL CHARACTERISTICS
MODEL RIM-8E		Surface-to-air/Surface	LENGTH 32 ft
NAME TALOS		TARGETS	DIAMETER
SERVICE USN		Air Surface	SPAN
MANUF. Bendix		Aircraft Ship/Shore	WEIGHT 7800# *
		Missiles Radars (2)	* including booster
WEAPON CHARACTERISTICS		PERFORMANCE CHARACTERISTICS	
WARHEAD		RANGE 100 NM	
FILLER Nuclear or HE		ALTITUDE 70,000 ft	
FUZING		FLIGHT TIME Velocity: Mach 2.5	
KILL MECH.		ACCURACY	
LETHAL AREA		P _K (SINGLE SHOT) 0.5	
LAUNCH CHARACTERISTICS		USING CRAFT	
SUSPENSION MK12 Launcher		Shipborne Equipment	
DELIVERY MODE		SPS-39 Search Radar	
RELEASE MODE		SPG-49 Tracking Radar	
LIMITATIONS		SPW-2 Guid Radar	
		MK2 Wpn Dir Equip	
GUIDANCE	PROPULSION	STATUS Inventory (1)	
PRELAUNCH	TYPE Booster: Solid Rocket		
BOOST Wing control	Sustainer: Ramjet		
MIDCOURSE Beam riding	MODEL		
TERMINAL Continuous Inter-	THRUST		
ferometer, semi-active		AVAILABILITY	
homing		DATE	
		NO.	
OPERATING SEQUENCE			
Targets identified by search radar missiles are steered during boost to a point in space where beam rider guidance takes over to terminal (10-15 second) semi-active homing			
REMARKS			
<ul style="list-style-type: none"> Available inventory approximates approval OSD inventory which is about half USN inventory objective TALOS ARM components, if approved for production, will be inserted in existing inventory of missiles. 			

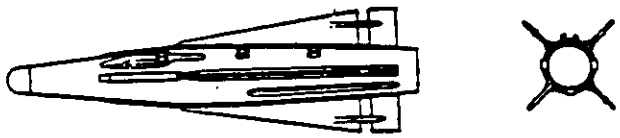
~~SECRET~~

TABLE 54

MUNITIONS DATA SHEET		GUIDED MISSILES															
DESIGNATION RIM-24 SERIES MODEL RIM-24B RIM-24C NAME TARTAR SERVICE US NAVY MANUF. General Dynamics/Pomona		CATEGORY MISSILE Surface-to-air and Surface TARGETS AIR SURFACE Aircraft Ships Missiles															
WEAPON CHARACTERISTICS WARHEAD RIM-24B Contin Rod RIM-24C Contin Rod FILLER HE HE FUZING Proximity Proximity & contact KILL MECH. Blast and Fragmentation LETHAL AREA		PHYSICAL CHARACTERISTICS LENGTH RIM-24B 172" RIM-24C 181" DIAMETER 13.5" 13.5" SPAN (Dorsal) 23" 23" (Tail) 42.6" 42.6" WEIGHT 1290 lbs 1300 lbs															
LAUNCH CHARACTERISTICS SUSPENSION MK 11, MK 13, MK 22 Launchers DELIVERY MODE RELEASE MODE Single LIMITATIONS		PERFORMANCE CHARACTERISTICS RANGE (Max) RIM-24B 17.5 NM RIM-24C 17.5 NM (Min) 2000 yd 2000 yd ALTITUDE (Max) 65 K ft 65 K ft (Min) 50 ft Surface FLIGHT TIME ACCURACY P_K (SINGLE SHOT) 0.6															
GUIDANCE PRELAUNCH BOOST MIDCOURSE Semi-active X-band CW homing TERMINAL Semi-active X-band CW homing		PROPULSION TYPE Solid propellant rocket MODEL MK 27 (DTM) THRUST															
		STATUS INVENTORY Approximately 2500 IT missiles are in RFI condition which closely approximates approved OSD inventory, but which is only about 60% of the USN inventory objective. Current IT missiles will be followed by standard missile (MR) production (See SM-1A)															
		AVAILABILITY <table border="1"> <thead> <tr> <th>DATE</th> <th>1967</th> <th>1968</th> <th>1969</th> <th>1970</th> <th>1971</th> <th>1972</th> </tr> </thead> <tbody> <tr> <td>NO.</td> <td>216</td> <td>280</td> <td>240</td> <td>270</td> <td>300</td> <td>25</td> </tr> </tbody> </table>		DATE	1967	1968	1969	1970	1971	1972	NO.	216	280	240	270	300	25
DATE	1967	1968	1969	1970	1971	1972											
NO.	216	280	240	270	300	25											
OPERATING SEQUENCE Launch into CW illuminating radar beam and home on the energy reflected from the target.																	
REMARKS 																	

~~SECRET~~

EB-9bbb

Table 54 to Annex B to Appendix E

~~SECRET~~

TABLE 54A

MUNITIONS DATA SHEET		DISPENSED MUNITIONS	
DESIGNATION		CATEGORY	PHYSICAL CHARACTERISTICS
MODEL Mine MK25 Mod 0 and 1		TARGETS Steel hull surface vessels 1000 tons and larger	LENGTH 128" DIAMETER 22 11/16" SPAN NA WEIGHT 1245-2033 lbs. depending on operational assembly
PART NA			
SERVICE Navy			
MARKING			
WEAPON CHARACTERISTICS		PERFORMANCE CHARACTERISTICS	
WARHEAD NA		RANGE NA	
FILLER 1235 lbs. HBX-3		ALTITUDE NA	
FUZING Magnetic/Acoustic		FLIGHT TIME NA	
KILL MECH. Blast/Pressure		ACCURACY NA	
LETHAL AREA Varies with water depth and target		Pz (SINGLE SHOT) NA	
LAUNCH CHARACTERISTICS		USING AIRCRAFT	
SUSPENSION MK 12 lugs 30" spacing		A-2	
DELIVERY MODE Parachute retarded		A-3	
RELEASE MODE See note 1		A-4C/E	
LIMITATIONS Planting depth 30'-120' (Mod 1) 30'-400' (Mod 0)		A-6	
		P-2E/A	
		P-3	
DISPENSER DATA	FUZES	STATUS	
	Mod 0 - actuates on magnetic influence	In inventory	WESTPAC WORLD-WIDE
	Mod 1 - actuates on acoustic influence	Mod 0 1570	2820
	Various options of ship counters	Mod 1 0	308
		AVAILABILITY	
		DATE	
		NO	
OPERATING SEQUENCE			
REMARKS			
1. Minimum altitude 200'. Airspeed must not exceed altitude up to a maximum of 450 kts (i.e. 200' - 200K, 300' - 300K, etc.)			

~~SECRET~~

EB-9ccc

Table 54A to Annex B to Appendix E

~~SECRET~~

TABLE 54B

MUNITIONS DATA SHEET		DISPENSED MUNITIONS	
DESIGNATION		CATEGORY	PHYSICAL CHARACTERISTICS
MODEL Mine MK3/ Mods 1 and 2		TARGETS Free hull vessels 1000' front and larger	LENGTH 108 1/2"
NAME NA			DIAMETER 19 1/2"
SERVICE Navy			SPAN NA
MANUF.			WEIGHT 1070-1157 lbs. depending on operational assembly
WEAPON CHARACTERISTICS		PERFORMANCE CHARACTERISTICS	
WARHEAD NA		RANGE NA	
FILLER 595 lbs. MKX-1		ALTITUDE NA	
FUZING Magnetic/Acoustic		FLIGHT TIME NA	
KILL MECH. Blast/pressure		ACCURACY NA	
LETAL AREA Varies with water depth and target		Pg (SINGLE SHOT) NA	
LAUNCH CHARACTERISTICS		USING AIRCRAFT	
SUSPENSION MK 13 - 0/1 1/4" spacing		A-1	
DELIVERY MODE Parachute retarded		A-3	
RELEASE MODE See note 1		A-4C/E	
LIMITATIONS Dropping depths 20'-120' (Mod 1)		A-6	
20'-400' (Mod 2)		P-2E/N	
		P-3	
DISPENSER DATA	FUZES	STATUS	
	Mod 1 actuates on magnetic influence	In Inventory	
	Mod 2 actuates on acoustic influence	WESTPAC WORLD-WIDE	
	Various options of ship counters	Mod 1 165	1362
		Mod 2 310	125
		AVAILABILITY	
		DATE	
		NO	
OPERATING SEQUENCE			
REMARKS			
1. Minimum altitude= 200'. Airspeed must not exceed altitude up to a maximum of 450 kts. (i.e. 200' - 200K, 300' - 300K, etc.)			

~~SECRET~~

EB-9ddd

Table 54B to
Annex B to
Appendix E

~~SECRET~~

TABLE 54C

MUNITIONS DATA SHEET		DISPENSED MUNITIONS	
DESIGNATION		CATEGORY	PHYSICAL CHARACTERISTICS
MODEL	M1n- MK50 Mod 0	TARGETS	LENGTH 89 5/8"
NAME	NA	Surface vessels 60-1000 tons	DIAMETER 14 1/4"
SERVICE	Navy		SPAN NA
MANUF.			WEIGHT 552-581 lbs. depending on operational assembly
WEAPON CHARACTERISTICS		PERFORMANCE CHARACTERISTICS	
WARHEAD	NA	RANGE	NA
FILLER	238 lbs. HBX-3	ALTITUDE	NA
FUZING	Acoustic	FLIGHT TIME	NA
KILL MECH.	Blast/pressure	ACCURACY	NA
LETHAL AREA	Varies with water depth and target	Pk (SINGLE SHOT)	NA
LAUNCH CHARACTERISTICS		USING AIRCRAFT	
SUSPENSION	Weld-on lug 14" spacing	A-1 A-3 A-4C/E A-6 P-2E/H P-3	
DELIVERY MODE	Parachute retarded		
RELEASE MODE	See note 1		
LIMITATIONS	Planting depths 12' - 60'		
DISPENSER DATA	FUZES	STATUS	
	Actuates on low frequency acoustic influence	In inventory	
	Various options of ship counters	WESTPAC 410 WORLD-WIDE 1052	
		AVAILABILITY	
		DATE	
		NO	
OPERATING SEQUENCE			
REMARKS			
1. Minimum altitude 200'. Airspeed must not exceed altitude up to a maximum of 450 kts (i.e. 200' - 200K, 300' - 300K, etc.)			

~~SECRET~~

EB-9eee

Table 54C to
Annex B to
Appendix E

~~SECRET~~

TABLE 54D

MUNITIONS DATA SHEET		DISPENSED MUNITIONS	
DESIGNATION		CATEGORY	PHYSICAL CHARACTERISTICS
MODEL Mine MK52 Mod 2		TARGETS	LENGTH 70 3/16"
NAME NA		Submarines	DIAMETER 18 13/16"
SERVICE Navy.			SPAN NA
MANUF.			WEIGHT 1169 lbs.
WEAPON CHARACTERISTICS		PERFORMANCE CHARACTERISTICS	
WARHEAD NA		RANGE NA	
FILLER 637 lbs. HBX-1		ALTITUDE NA	
FUZING Magnetic		FLIGHT TIME NA	
KILL MECH. Blast/Pressure		ACCURACY NA	
LETHAL AREA Varies with water depth and target		P_g (SINGLE SHOT) NA	
LAUNCH CHARACTERISTICS		USING AIRCRAFT	
SUSPENSION MK 6 lug 14" spacing		A-1	
DELIVERY MODE Parachute retarded		A-3	
RELEASE MODE See note 1		A-4C/E	
LIMITATIONS Planting depths 18' - 60'		A-6	
		P-2E/H	
		P-3	
DISPENSER DATA	FUZES	STATUS	
	Actuates on magnetic influence Various options of ship counters	In inventory WESTPAC 579	
		WORLD-WIDE 125%	
		AVAILABILITY	
		DATE	
		NO	
OPERATING SEQUENCE			
REMARKS			
<ol style="list-style-type: none"> Minimum altitude 200 ft. Airspeed must be equal to altitude up to a maximum of 475 knots (i.e. 200' - 200K, 300' - 300K, etc.) By careful selection of water depths and sensitivity setting, this mine can be effectively employed against surface vessels including those used for intra-coastal shipping in Southeast Asia. 			

~~SECRET~~

EB-9fff

Table 54D to
Annex B to
Appendix E

MUNITIONS AVAILABLE FOR SOUTHEAST ASIA
IN FY 68

BOMBS a/

M117R	750# GPHD (See M117)
MLU-10/B	750# MINE
BLU-14/B	750# MINE (See MLU-10/B)
BLU-31/B	750# DEMOL
BLU-34/B	3000# DEMOL

MUNITIONS DISPENSERS b/

MINES, WATER & LAND^{e/}

CBU-28/A	Ejector Sys	Destructor Mk 36
CBU-29/B	Cluster Bomb	
CBU-34/A	Ejector Sys	
CBU-35/B	Cluster Bomb	
CBU-36/B	Cluster Bomb	
XM-47	Ejector Sys	

DISPENSED SUBMUNITIONS c/

BLU-36/B	Bomblet (See BLU-26/B)
BLU-40/B	Bomblet (See BLU-24/B)
BLU-41/B	Bomblet (See BLU-26/B)
BLU-42/B	WAAPM
BLU-43/B, 44/B	DRAGON TOOTH
XM-27	Mine

GUN PODS

SUU-23/A	20mm (See SUU-16/A)
----------	---------------------

MISSILES d/

AGM-63A	STANDARD ARM
RIM-8	TALOS ARM

- a/ See tables 55 through 58
- b/ See tables 59 through 62
- c/ See tables 63 through 66
- d/ See tables 67 and 68
- e/ See table 68A

~~SECRET~~

TABLE 55

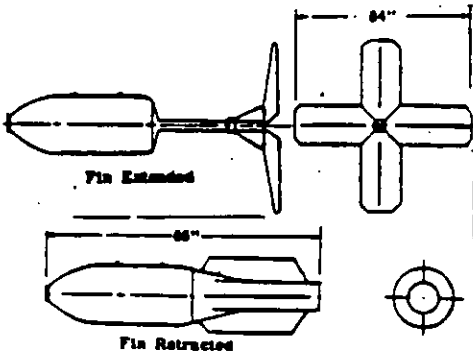
MUNITIONS DATA SHEET		BOMBS	
DESIGNATION MODEL M117R NAME Retarded M117 SERVICE USAP MANUF.		CATEGORY RETARDED GP BOMB Air-to sur- TARGETS face Anti-material Anti-Personnel	
WEAPON CHARACTERISTICS WARHEAD FILLER 386 lb Tritonal FUZING Contact or delay KILL RECN. Blast & fragmentation LETHAL AREA		PHYSICAL CHARACTERISTICS LENGTH 86.0 " DIAMETER 16.0 " SPAN 22.0 " (retracted) WEIGHT 870 lb 84.0 in extended fin span	
LAUNCH CHARACTERISTICS SUSPENSION 14" lugs DELIVERY MODE Dive, level, toss RELEASE MODE Single, stick, salvo LIMITATIONS 600 KIAS, 30' min alt retarded or low drag release optional		PERFORMANCE CHARACTERISTICS RANGE ALTITUDE 50' (min) FLIGHT TIME ACCURACY P _K (SINGLE SHOT)	
USING AIRCRAFT F-100 F-105 F-4C F-111 B-47 B-52 B-57 B-26 A-1E A-7A T-28		STATUS Development Retarder and retardation sensing fuse in development	
STABILIZATION		FUZES Nose WSOE1 PMU-26/B PMU-35/B PMU-54/B Tail WSOE PMU-26/B PMU-35/B PMU-35/B	
		AVAILABILITY DATE NO	
OPERATING SEQUENCE			
REMARKS 			

~~SECRET~~

EB-10a

Table 55 to
Annex B to
Appendix E

TABLE 56

MUNITIONS DATA SHEET		BOMBS	
DESIGNATION MODEL MLU-10/B, BLU-14/B NAME LAND MINE/SKIP BOMB SERVICE USAP MANUF.		CATEGORY/PENETRATION/SKIP BOMB AIR-TARGETS to-surface Anti-Materiel PHYSICAL CHARACTERISTICS LENGTH 90.6" DIAMETER 10.75" SPAN 15.1" WEIGHT 660 lb	
WEAPON CHARACTERISTICS WARHEAD FILLER 250 lb Tritonal FUZING Medium delay, impact KILL MECH. Penetration, cratering & blast LETHAL AREA		PERFORMANCE CHARACTERISTICS RANGE ALTITUDE FLIGHT TIME ACCURACY P _r (SINGLE SHOT)	
LAUNCH CHARACTERISTICS SUSPENSION 14" lugs DELIVERY MODE Low level or low angle dive RELEASE MODE Single, stick or salvo LIMITATIONS 600 KIAS		USING AIRCRAFT F-100 F-105 F-4C F-111 A-1E T-28 B-26 B-57 A-7A	
STABILIZATION Navy Mk 82 Low Drag Fin		FUZES Tail M905 (12 sec delay) FWU-26/B FWU-35/B	
		STATUS Development AVAILABILITY DATE NO	
OPERATING SEQUENCE			
REMARKS (1) Consists of the MLU-10/B mine case and a modified Mk 82 fin. The blunt nose limits ricochet when released under low-altitude high-speed conditions.			

~~SECRET~~

TABLE 57

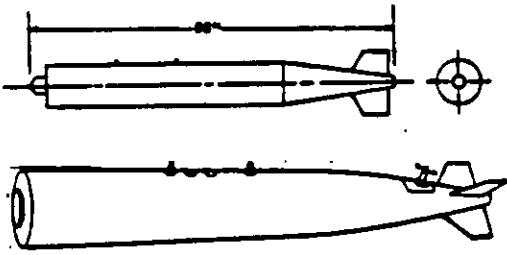
MUNITIONS DATA SHEET		BOMBS		
DESIGNATION		CATEGORY DEMOLITION BOMB Air-to-TARGETS surface Anti-railroads, vehicles, hard targets	PHYSICAL CHARACTERISTICS	
MODEL	BLU-31/B (1)		LENGTH	96 "
NAME	Hard Structure Munition		DIAMETER	10.75"
SERVICE	USAF.		SPAN	15.1 "
MARUF.	U. S. Steel		WEIGHT	800 lb
WEAPON CHARACTERISTICS		PERFORMANCE CHARACTERISTICS		
WARHEAD		RANGE		
FILLER	250 lb Tritonal	ALTITUDE		
FUZING	PMU-30/B influence fuse	FLIGHT TIME		
KILL MECH.	Blast & cratering	ACCURACY		
LETHAL AREA	35 ft crater	P_r (SINGLE SHOT)		
LAUNCH CHARACTERISTICS		USING AIRCRAFT		
SUSPENSION	14" lugs	F-100		
DELIVERY MODE	Shallow dive	F-105		
RELEASE MODE	Single, stick or train salvo	F-4C/D		
LIMITATIONS	600 KIAS	F-111		
		A-1E		
		T-28		
		B-26		
		B-57		
		A-7A		
STABILIZATION	FUZES	STATUS		
Navy Mk 82 tail fin	PMU-30/B-Pressure sensing fuse armed 10 min after impact. It detonates the charge upon sensing a pressure signal from a passing train. Sensitivity radius is 25 ft. Fuse self destructs mine when battery drops below a present level. Fuse can be set to count up to 4 targets before firing.	Eng'rg Development Task 253701 Development Apr 67 Production Aug 67, 200/month authorized by OSD. First combat deployment Nov 67.		
		AVAILABILITY		
		DATE	Aug 67	
		NO	200	
OPERATING SEQUENCE				
REMARKS				
<p>(1) The BLU-31/B is the new designation for both the BLU-14/B and the MLU-10/B. The new weapon is a single piece forged case whereas the old items used a two piece welded construction.</p> 				

~~SECRET~~

EB-10c

Table 57 to Annex B to Appendix E

TABLE 58

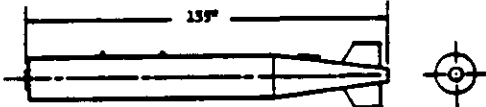
MUNITIONS DATA SHEET		BOMBS	
DESIGNATION MODEL BLU-34/B NAME 3000 lb GP SERVICE MARK.		CATEGORY PENETRATION Air-to-TARGETS surface Bridge destruction (1)	PHYSICAL CHARACTERISTICS LENGTH 155 " DIAMETER 18 " SPAN WEIGHT
WEAPON CHARACTERISTICS WARHEAD FILLER Tritonal with D-2 desensitizer FUZING Delay KILL MECH: Penetration, cratering & blast LETAL AREA: crater, 15' deep		PERFORMANCE CHARACTERISTICS RANGE ALTITUDE FLIGHT TIME ACCURACY P _r (SINGLE SHOT)	
LAUNCH CHARACTERISTICS SUSPENSION 30" lugs DELIVERY MODE Low or high level RELEASE MODE LIMITATIONS		USING AIRCRAFT	
STABILIZATION	FUZES	STATUS Eng'g Development Task 253703 Development Funded May 1966 Qualification Contract scheduled for Sep 66 to support production rate of 1000/month. IOC estim Sep 67. AVAILABILITY DATE NO	
OPERATING SEQUENCE			
REMARKS (1) Bluff shape anti-ricochet design. Maybe used as a land mine with proper fuzing. 			

~~SECRET~~

TABLE 59

MUNITIONS DATA SHEET		DISPENSED MUNITIONS	
DESIGNATION MODEL CBU-28/A NAME DRAGONTOOTH DISPENSER SERVICE USAF MANUF.		CATEGORY DISPENSER SYSTEM TARGETS Area denial Anti-personnel mine	
		PHYSICAL CHARACTERISTICS LENGTH 101.25 in DIAMETER 14.75 in wide SPAN 13.735 in height WEIGHT 625 lb	
WEAPON CHARACTERISTICS WARHEAD 5760 BLU-43/B mines g/ FILLER Nitro-paraffin FUZING Hydraulic pressure KILL MECH. Blast LETHAL AREA		PERFORMANCE CHARACTERISTICS RANGE ALTITUDE FLIGHT TIME ACCURACY P _R (SINGLE SHOT)	
LAUNCH CHARACTERISTICS SUSPENSION 14" lugs, all stations incl. MER DELIVERY MODE Low level, high speed RELEASE MODE Ripple LIMITATIONS 600 Kts (max) & g's		USING AIRCRAFT F-100 F-105 F-4C F-111 A-7A	
DISPENSER DATA SUU-13/A dispenser with 40 canisters each having 144 Dragon Tooth mines	FUZES	STATUS Development	
		AVAILABILITY DATE NO	
OPERATING SEQUENCE			
REMARKS ✓ The "Dragontooth" mine is a triangular wedge in shape with dimensions of 4" x 1 3/8". The weight is approximately 1 oz. The mine has a hydraulically actuated fuze with the hydraulic fluid (a nitro-paraffin) acting also as the explosive. The mine is clustered eight to a circular disc with a total of 144 in each canister of the SUU-13/A dispenser.			
EIGHT MINES ARE CLUSTERED FOR CANNISTERS			

~~SECRET~~

EB-10e

Table 59 to
Annex B to
Appendix E

TABLE 60



MUNITIONS DATA SHEET		DISPENSED MUNITIONS													
DESIGNATION MODEL CRU-29/B, 36/B g/ NAME Cluster Bomb SERVICE USAF MANUF. Aerojet/Honeywell		CATEGORY Air-to-surface TARGETS area target Anti-personnel/ materiel													
WEAPON CHARACTERISTICS WARHEAD 665-670 DU-36/B Bomblets FILLER 139# HE FUZING Timed or proximity airburst KILL MECH. Fragmentation LETHAL AREA		PHYSICAL CHARACTERISTICS LENGTH 90.0" DIAMETER 15.0 SPAN 30.0 WEIGHT 830#													
LAUNCH CHARACTERISTICS SUSPENSION 14" lugs DELIVERY MODE Dive, glide, level, or toss RELEASE MODE Single, stick or salvo LIMITATIONS 650 Kts or Mach 1.2, 4 g's		PERFORMANCE CHARACTERISTICS RANGE ALTITUDE FLIGHT TIME ACCURACY P _g (SINGLE SHOT) Remarks g/													
DISPENSER DATA CRU-30/R (CRU-29/B) CRU-39/R (CRU-36/B)		USING AIRCRAFT F-100 (4) F-105 (7) F-4C (8) F-111 B-57 A-7A A-1E													
FUZES M907 (CRU-29/B) PMU-56/B (CRU-36/B) M218 (BUU-26/B) spin armed, random time fuze (0-120 min)		STATUS Production AVAILABILITY DATE <table border="1"><tr><td> </td><td> </td><td> </td><td> </td><td> </td><td> </td></tr></table> NO <table border="1"><tr><td> </td><td> </td><td> </td><td> </td><td> </td><td> </td></tr></table>													
OPERATING SEQUENCE Cluster bomb splits longitudinally by the time fuze, allowing bomblets to free fall over a dispersed area. CBU-36/B has a radar altimeter fuze capability.															
REMARKS g/ CRU-29/B and CRU-36/B are similar to the CRU-24/B and CBU-35/B respectively, except for the submission fuzes.															
															

TABLE 61

MUNITIONS DATA SHEET		DISPENSED MUNITIONS	
DESIGNATION MODEL CBU-34/A NAME TPIW-WAAPM g/ SERVICE USAF MANUF.		CATEGORY DISPENSION SYSTEM TARGETS Area denial	
WEAPON CHARACTERISTICS WARHEAD 540 BLU-42/B WAAPM g/ FILLER FUZING Spin armed KILL MECH. LETNAL AREA		PHYSICAL CHARACTERISTICS LENGTH 139.7 in DIAMETER 15.3 in (width) SPAN 16.5 in (height) WEIGHT	
PERFORMANCE CHARACTERISTICS RANGE ALTITUDE FLIGHT TIME ACCURACY P _R (SINGLE SHOT) g/		LAUNCH CHARACTERISTICS SUSPENSION DELIVERY MODE RELEASE MODE LIMITATIONS	
DISPENSER DATA SUU-38/A Tactical Fighter Dispenser		FUZES	
		STATUS Development AVAILABILITY DATE NO	
OPERATING SEQUENCE			
REMARKS  <p>g/ Wide Area Anti-Personnel Mine</p> <p>h/ BLU-42/B, 2.25" dia, 0.92 lb, deploys 8 wires to 25 ft, 144 hr self destruct.</p> <p>z/ Single TPD provides 5 mile barrier, 300 ft wide (25%) 2.3 mile x 300 ft at 50% probability of functioning. SUU-24/A (B-52) 50 mile long, 3500 ft wide at 30% level.</p>			

~~SECRET~~

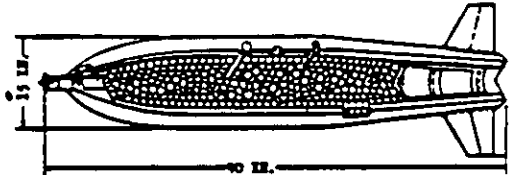
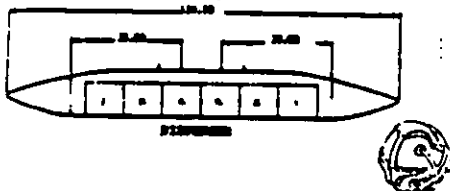
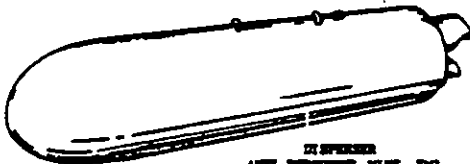
TABLE 62

MUNITIONS DATA SHEET		DISPENSED MUNITIONS																	
DESIGNATION MODEL XM47 NAME Gravel Mine SERVICE Army MANUF.		CATEGORY DISPENSING SYSTEM TARGETS Area Denial Anti-personnel																	
		PHYSICAL CHARACTERISTICS LENGTH 23 in DIAMETER 18.5 in SPAN WEIGHT 525 lb																	
WEAPON CHARACTERISTICS WARHEAD 1200 XM27 Mod 2 AP Mine (Gravel) FILLER FUZING KILL MECH. Blast LETHAL AREA		PERFORMANCE CHARACTERISTICS RANGE ALTITUDE FLIGHT TIME ACCURACY P _r (SINGLE SHOT)																	
LAUNCH CHARACTERISTICS SUSPENSION 14" lugs DELIVERY MODE Low level (200-500') RELEASE MODE LIMITATIONS		USING AIRCRAFT A-1E OB-1B																	
DISPENSER DATA XM3 Dispenser with four XM2 canisters, each with 300 XM27 mines.	FUZES	STATUS Production																	
		AVAILABILITY <table border="1"> <tr> <td>DATE</td> <td></td> <td></td> <td></td> <td></td> <td></td> <td></td> <td></td> </tr> <tr> <td>NO</td> <td></td> <td></td> <td></td> <td></td> <td></td> <td></td> <td></td> </tr> </table>		DATE								NO							
DATE																			
NO																			
OPERATING SEQUENCE																			
REMARKS <div style="text-align: center;">  DISPENSER ANTI-PERSONNEL MINE, DO </div> <div style="text-align: center;">  MINE XM27 </div>																			

~~SECRET~~

EB-10h

Table 62 to
Annex B to
Appendix E

~~SECRET~~

TABLE 63

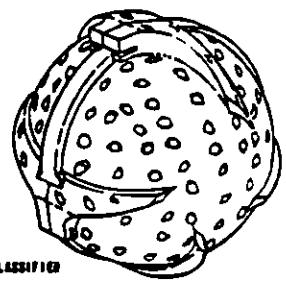
MUNITIONS DATA SHEET		DISPENSED MUNITIONS	
DESIGNATION MODEL BLU-36/B NAME SERVICE USAF MANUF. Honeywell		CATEGORY BOMB Area-Surface Targets Area coverage, anti-personnel/ materiel	
WEAPON CHARACTERISTICS WARHEAD Steel balls in aluminum matrix FILLER FUZING Spin armed, impact detonation KILL MECH. Fragmentation LETNAL AREA		PHYSICAL CHARACTERISTICS LENGTH DIAMETER SPAN WEIGHT 0.94 lb	
LAUNCH CHARACTERISTICS SUSPENSION CBU-29/B, 36/B Munition, 14" lug DELIVERY MODE Level, dive or toss RELEASE MODE Cluster LIMITATIONS		PERFORMANCE CHARACTERISTICS RANGE ALTITUDE FLIGHT TIME ACCURACY P _r (SINGLE SHOT)	
DISPENSER DATA SUU-30/B (CBU-29/B) SUU-39/B (CBU-36/B)		FUZES M216 random timefuse, varies from 0 to 120 min	
		STATUS AVAILABILITY DATE NO	
OPERATING SEQUENCE			
REMARKS <div style="text-align: right;">  </div>			

DECLASSIFIED

~~SECRET~~

EB-101

Table 63 to
Annex B to
Appendix E

TABLE 64

MUNITIONS DATA SHEET		DISPENSED MUNITIONS													
DESIGNATION MODEL H111-42/A NAME "WAAP" a/ SERVICE USAF MANUF. Honeywell, Inc.		CATEGORY NINE Air-to-surface TARGETS Area coverage Anti-personnel													
WEAPON CHARACTERISTICS WARHEAD Clustered Iron FILLER Comp B FUZING Electrical anti-disturbance long period self destruct (144 hrs.) KILL MECH. Fragments, 1-5 grams each LETHAL AREA 30 ft b/		PHYSICAL CHARACTERISTICS LENGTH DIAMETER 2.38 in SPAN WEIGHT 0.92 lbs													
LAUNCH CHARACTERISTICS SUSPENSION SIMU-38/A, 14" x 30" lugs DELIVERY MODE Level, Dive RELEASE MODE LIMITATIONS Mach 1.2		PERFORMANCE CHARACTERISTICS RANGE ALTITUDE above 100 ft FLIGHT TIME ACCURACY P _k (SINGLE SHOT) 0.6 g/													
USING AIRCRAFT F-4 F-105 F-100 A-7 A-1E		STATUS Eng'rg devel proj 1792 Production: Oct 67, 108,000 approved OSD (200 disp per mo)													
DISPENSER DATA CRU-34/A with 540 bomblets Other possible dispensers include: CRU-13/A (405 bomblets) CRU-30/A (700 bomblets) CRU-24/A (14760 bomblets)		FUZES													
		AVAILABILITY <table border="1"> <tr> <td>DATE</td> <td>NO</td> <td>Small</td> <td>FY 68</td> <td></td> <td></td> </tr> <tr> <td></td> <td></td> <td></td> <td>108,000</td> <td></td> <td></td> </tr> </table>		DATE	NO	Small	FY 68						108,000		
DATE	NO	Small	FY 68												
			108,000												
OPERATING SEQUENCE															
REMARKS a/ Wide area anti-personnel mine b/ Eight tripwires extend to 20 ft c/ At 600 kts and 0.2 sec interval, coverage pattern is 900 x 7000 ft with P _k = 0.49 at 400 kts and 0.2 sec interval, coverage pattern is 700 x 4600 ft with P _k = 0.65															
															

TABLE 65

MUNITIONS DATA SHEET		DISPENSED MUNITIONS													
DESIGNATION MODEL RIM-43/B, 44/B NAME DRAGON TOOTH SERVICE USAF MANUF. Aerojet General		CATEGORY MINE Air-to-surface TARGETS Area coverage Anti-personnel													
WEAPON CHARACTERISTICS WARHEAD FILLER Nitro-paraffin fuel, sensitizer FUZING Pressure sensitive (hydraulic) KILL MECH. Blast LETHAL AREA Contact with mine incapacitating		PHYSICAL CHARACTERISTICS LENGTH Triangular wedge DIAMETER 1/2 x 1 3/4 x 1 3/4 SPAN WEIGHT 0.71 oz													
LAUNCH CHARACTERISTICS SUSPENSION SSII-13/A, 14" lugs DELIVERY MODE low level RELEASE MODE ripple LIMITATIONS 600 KIAS above 150 ft, 4 g's		PERFORMANCE CHARACTERISTICS RANGE ALTITUDE 150 ft (min) FLIGHT TIME ACCURACY P _R (SINGLE SHOT) 0.7													
DISPENSER DATA The CBU-28/A used the SSII-13/A(5120 mines) 40 canisters with 120 each loaded #62# Empty 157#		USING AIRCRAFT All fighter A/C with 14" lugs F-100 F-105 F-4C/D A-1E F-111 A-7A													
FUZES Desterilization pellets in fuel 100% blast to 60 hr 90-95% at 71 hr, 0% at 72 hr		STATUS Development Task 250704 Development: Complete Qualification: May 1967 Production: Jun 1967 AVAILABILITY <table border="1"> <thead> <tr> <th>DAY</th> <th>CYCLE</th> <th>WATER</th> <th></th> <th></th> <th></th> </tr> </thead> <tbody> <tr> <td>NO</td> <td>4.3</td> <td>3.5</td> <td>1111</td> <td>du</td> <td>month</td> </tr> </tbody> </table>		DAY	CYCLE	WATER				NO	4.3	3.5	1111	du	month
DAY	CYCLE	WATER													
NO	4.3	3.5	1111	du	month										
OPERATING SEQUENCE															
REMARKS															
															
<small>EMPTY MINE AS CLASSIFIED FOR CARTRIDGE</small>															

TABLE 66

MUNITIONS DATA SHEET		DISPENSED MUNITIONS	
DESIGNATION MODEL XM27 Mod 2 NAME Gravel <i>A/</i> SERVICE MANUF.		CATEGORY DISPENSED MUNITION Air-to-Surface TARGETS Area targets Personnel	
		PHYSICAL CHARACTERISTICS LENGTH 3 1/2" Radius Quadrant DIAMETER 6 1/2" (4 mines) SPAN 3/4" thick WEIGHT 3 1/2 oz.	
WEAPON CHARACTERISTICS COMMAN Item <i>A/</i> WARHEAD FILLER FUZING KILL MECH. LETHAL AREA		PERFORMANCE CHARACTERISTICS RANGE ALTITUDE FLIGHT TIME ACCURACY P _K (SINGLE SHOT)	
LAUNCH CHARACTERISTICS SUSPENSION DELIVERY MODE RELEASE MODE LIMITATIONS		USING AIRCRAFT	
DISPENSER DATA XM3 Dispenser with 4 XMZ canisters, each with 300 XM 27's		FUZES	
		STATUS AVAILABILITY DATE NO	
OPERATING SEQUENCE			
REMARKS <i>A/</i> A fabric covered anti-personnel mine which detonates when stepped on and will incapacitate through combat boots. If not detonated it self sterilizes by pulling water from the atmosphere through the fabric case of the mine. Versene chemical dissolved by water reacts with lead azide of the explosive to inert the mine. Sterilization depends upon temperature and humidity with times varying from 12 hours at 125 degrees F to three days at 50 degrees F.			
 MINE XM27			

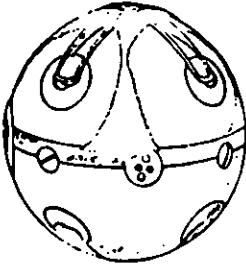
TABLE 67

MUNITIONS DATA SHEET		GUIDED MISSILES																																																																																																						
DESIGNATION MODEL AGM 63A NAME STANDARD ARM SERVICE USN MANUF. Gen. Dynamics, Pomona		CATEGORY MISSILE Air-to-Surface TARGETS Radars																																																																																																						
WEAPON CHARACTERISTICS WARHEAD Directed blast and fragment FILLER 2171B FUZING Active, passive, contact KILL MECH. Blast and Fragmentation LETHAL AREA		PHYSICAL CHARACTERISTICS LENGTH 178 in DIAMETER 13.5 in SPAN 24" (folded), 42.5 (open) WEIGHT 13-50 lb																																																																																																						
PERFORMANCE CHARACTERISTICS RANGE 30 NM 60 NM 75 NM ALTITUDE 200 ft. 20000 40000 FLIGHT TIME 55 sec @ 20 MI ACCURACY 30 ft. CEP P _R (SINGLE SHOT)		LAUNCH CHARACTERISTICS SUSPENSION DELIVERY MODE RELEASE MODE LIMITATIONS																																																																																																						
GUIDANCE PRELAUNCH S.C.X & L Band detection BOOST Passive homing MIDCOURSE Passive homing TERMINAL Passive homing Mod 0-S Band Seeker Mod 1-S, C, X Band Seeker		PROPULSION TYPE MODEL THRUST																																																																																																						
STATUS Planned deployment Mod 0: CY 1967 Mod 1: MAR 1968 Mod 2: DEC 1968 Production: Not yet authorized; rates not established; however message JCS 1725/613-5, dtd 7 Mar 67, recommended AVAILABILITY the numbers shown below.		<table border="1"> <tr> <th>DATE</th> <th>NO</th> <th></th> <th></th> <th></th> <th></th> </tr> <tr> <td></td> <td></td> <td></td> <td></td> <td></td> <td></td> </tr> </table>		DATE	NO																																																																																																			
DATE	NO																																																																																																							
OPERATING SEQUENCE Broadband frequency seeker detects and identifies radar before launch. Lock-on initiated before launch. Target homing from launch through boost glide sequence.																																																																																																								
<table border="1"> <thead> <tr> <th rowspan="2">REMARKS</th> <th rowspan="2">SHRIKE</th> <th colspan="3">JCS-PROPOSED STANDARD ARM TACTICAL MISSILE DELIVERIES</th> </tr> <tr> <th>MOD 0</th> <th>MOD 1</th> <th>MOD 2</th> </tr> </thead> <tbody> <tr> <td rowspan="12"> 1/ Requirements expressed are for ready-for issue quantities. 2/ The dissimilarity in the ending of the FY68 funding period between the SHRIKE and the STANDARD ARM did not permit a trade-off of the last 450 ARMS produced. </td> <td>1968 Mar 600</td> <td>57</td> <td>7</td> <td></td> </tr> <tr> <td>Apr 600</td> <td>48</td> <td>48</td> <td></td> </tr> <tr> <td>May 600</td> <td>37</td> <td>42</td> <td></td> </tr> <tr> <td>Jun 600</td> <td>28</td> <td>68</td> <td></td> </tr> <tr> <td>Jul 575-(25)</td> <td>10</td> <td>80</td> <td>7</td> </tr> <tr> <td>Aug 550-(50)</td> <td>T 400</td> <td>92</td> <td>30</td> </tr> <tr> <td>Sep 520-(80)</td> <td></td> <td>85</td> <td>25</td> </tr> <tr> <td>Oct 475-(125)</td> <td></td> <td>75</td> <td>65</td> </tr> <tr> <td>Nov 450-(150)</td> <td></td> <td>70</td> <td>75</td> </tr> <tr> <td>Dec 425-(175)</td> <td></td> <td>43</td> <td>85</td> </tr> <tr> <td>1969 Jan 400-(200)</td> <td></td> <td>10</td> <td>105</td> </tr> <tr> <td>Feb 375-(225)</td> <td></td> <td>T 620</td> <td>125</td> </tr> <tr> <td>Mar 350-(250)</td> <td></td> <td></td> <td></td> </tr> <tr> <td>1967 Sep 550</td> <td></td> <td>T 660</td> <td>143</td> </tr> <tr> <td>Oct 600</td> <td></td> <td>(1,280)</td> <td>150</td> </tr> <tr> <td>Nov 600</td> <td></td> <td></td> <td>150</td> </tr> <tr> <td>Dec 600</td> <td></td> <td></td> <td>150</td> </tr> <tr> <td>1968 Jan 600</td> <td></td> <td></td> <td>1,110 End of FY 68 Procurement</td> </tr> <tr> <td>Feb 600</td> <td></td> <td></td> <td></td> </tr> <tr> <td></td> <td>Apr 8,320 (1,280)</td> <td></td> <td></td> </tr> <tr> <td></td> <td>May End of Procurement</td> <td></td> <td></td> </tr> <tr> <td></td> <td>Jun FY 68</td> <td></td> <td></td> </tr> <tr> <td></td> <td></td> <td colspan="2">Cumulative Tactical Trade-Off</td> </tr> </tbody> </table>				REMARKS	SHRIKE	JCS-PROPOSED STANDARD ARM TACTICAL MISSILE DELIVERIES			MOD 0	MOD 1	MOD 2	1/ Requirements expressed are for ready-for issue quantities. 2/ The dissimilarity in the ending of the FY68 funding period between the SHRIKE and the STANDARD ARM did not permit a trade-off of the last 450 ARMS produced.	1968 Mar 600	57	7		Apr 600	48	48		May 600	37	42		Jun 600	28	68		Jul 575-(25)	10	80	7	Aug 550-(50)	T 400	92	30	Sep 520-(80)		85	25	Oct 475-(125)		75	65	Nov 450-(150)		70	75	Dec 425-(175)		43	85	1969 Jan 400-(200)		10	105	Feb 375-(225)		T 620	125	Mar 350-(250)				1967 Sep 550		T 660	143	Oct 600		(1,280)	150	Nov 600			150	Dec 600			150	1968 Jan 600			1,110 End of FY 68 Procurement	Feb 600					Apr 8,320 (1,280)				May End of Procurement				Jun FY 68					Cumulative Tactical Trade-Off	
REMARKS	SHRIKE	JCS-PROPOSED STANDARD ARM TACTICAL MISSILE DELIVERIES																																																																																																						
		MOD 0	MOD 1	MOD 2																																																																																																				
1/ Requirements expressed are for ready-for issue quantities. 2/ The dissimilarity in the ending of the FY68 funding period between the SHRIKE and the STANDARD ARM did not permit a trade-off of the last 450 ARMS produced.	1968 Mar 600	57	7																																																																																																					
	Apr 600	48	48																																																																																																					
	May 600	37	42																																																																																																					
	Jun 600	28	68																																																																																																					
	Jul 575-(25)	10	80	7																																																																																																				
	Aug 550-(50)	T 400	92	30																																																																																																				
	Sep 520-(80)		85	25																																																																																																				
	Oct 475-(125)		75	65																																																																																																				
	Nov 450-(150)		70	75																																																																																																				
	Dec 425-(175)		43	85																																																																																																				
	1969 Jan 400-(200)		10	105																																																																																																				
	Feb 375-(225)		T 620	125																																																																																																				
Mar 350-(250)																																																																																																								
1967 Sep 550		T 660	143																																																																																																					
Oct 600		(1,280)	150																																																																																																					
Nov 600			150																																																																																																					
Dec 600			150																																																																																																					
1968 Jan 600			1,110 End of FY 68 Procurement																																																																																																					
Feb 600																																																																																																								
	Apr 8,320 (1,280)																																																																																																							
	May End of Procurement																																																																																																							
	Jun FY 68																																																																																																							
		Cumulative Tactical Trade-Off																																																																																																						

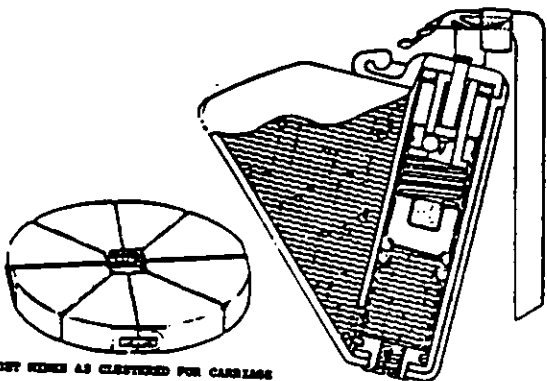
TABLE 68

MUNITIONS DATA SHEET		GUIDED MISSILES	
DESIGNATION MODEL RIM-8 Modified NAME TALOS ARM SERVICE USN MANUF. Bendix Missile Div		CATEGORY MISSILE Surface-to-surface TARGETS Radiating Radar sources, discrimination 12 mhz, PRF: 95/5%	
WEAPON CHARACTERISTICS WARHEAD Continuous Rod FILLER 220 # HE FUZING Proximity and/or contact KILL MECH. Fragmentation & Rods LETHAL AREA 70 ft		PHYSICAL CHARACTERISTICS LENGTH 208' #134 (booster) DIAMETER 30" SPAN 110" WEIGHT 7779# (total) 3404# (missile only)	
LAUNCH CHARACTERISTICS SUSPENSION Rail launcher DELIVERY MODE RELEASE MODE LIMITATIONS Flight Reliability, missile 82% system 85%, over-all 70%		PERFORMANCE CHARACTERISTICS RANGE 230,000 yds ALTITUDE Surface to 70000 during midcourse FLIGHT TIME 300 sec (max) velocity Mach 2.5 ACCURACY 15-30 ft CEP Pk (SINGLE SHOT) 0.6	
USING CRAFT Surface Ships		STATUS Development Production: Not yet authorized g/	
GUIDANCE PRELAUNCH BOOST Wing control MIDCOURSE Beam riding TERMINAL Homes on highest PRF in assigned frequency interval		PROPULSION TYPE Solid rocket booster ramjet sustainer MODEL THRUST 102-106,000 # (boost) 9000 # (ramjet) booster wt: 4375#	
		AVAILABILITY DATE NO.	
OPERATING SEQUENCE Pig look aircraft relays site location, freq, and PRF to ship within 30 NM of target. Ship selects missile with proper freq. Coverage, sets PRF limits and target coordinates, and launches missile.			
REMARKS g/ First P&S-Band units can be provided six months after funding and authorization to commence production.			

~~SECRET~~

TABLE 68A

MUNITIONS DATA SHEET		DISPENSED MUNITIONS																		
DESIGNATION MODEL MK-36 a/		CATEGORY TARGETS b/																		
NAME Destructor MK 36		PHYSICAL CHARACTERISTICS LENGTH - 89" DIAMETER - 10.8" SPAN - 15" fins retracted; 45" fins extended WEIGHT - 571 lbs.																		
SERVICE USMC MANUF.		Ships Junks All water craft Personnel Vehicles																		
WEAPON CHARACTERISTICS WARHEAD FILLER 192 lb Tritonal FUZES KILL MECH. Blast and Fragmentation LETHAL AREA		OPERATIONAL CHARACTERISTICS The firing device houses a thin-film magnetometer sensor, interval timer, self-destruct feature, inhibit circuit to protect against explosive counter-measures, signal processing logic, and a detonating signal. The firing device fits in the tail fuze of the MK 82 bomb case. The nose fuze M-904 has been modified to provide a water-tight seal and together with the M-134 adapter booster provides explosive train alignment and detonator.																		
LAUNCH CHARACTERISTICS SUSPENSION 14" lugs DELIVERY MODE Dive or low level RELEASE MODE Single, stick, or salvo LIMITATIONS 600 KIAS, 100 ft min altitude		USING AIRCRAFT F-4 (all) F-8 F-105 A-1 (all) A-4 (All) A-6A																		
DISPENSER DATA Delivered by any aircraft capable of delivering the MK 82 SNAKEYE. Delivery techniques and trajectory factors are identical to the MK 82 SNAKEYE.		FUZES Kit containing adapter booster M-134, modified nose fuze M-904, sealing plug and tools is used to modify the MK 82 SNAKEYE low drag bomb into a land or sea mine.																		
		STATUS Basic weapon (MK 82 low drag bomb with MK 15 SNAKEYE fins) is in inventory and production 5%. Adaptor kits are to be delivered according to the following schedule: (Total procurement authorization is for 42,375 kits). (Each kit will cost an estimated \$400)																		
		AVAILABILITY <table border="1"> <tr> <td>DATE</td> <td>May 71</td> <td>June 71</td> <td>July 71</td> <td>Aug 71</td> <td>Sept 71</td> <td>Oct 71</td> <td>Nov 71</td> <td>Dec 71</td> </tr> <tr> <td>NO</td> <td>175</td> <td>2150</td> <td>3600</td> <td>per mo</td> <td>if then on</td> <td></td> <td></td> <td></td> </tr> </table>	DATE	May 71	June 71	July 71	Aug 71	Sept 71	Oct 71	Nov 71	Dec 71	NO	175	2150	3600	per mo	if then on			
DATE	May 71	June 71	July 71	Aug 71	Sept 71	Oct 71	Nov 71	Dec 71												
NO	175	2150	3600	per mo	if then on															
OPERATING SEQUENCE The Destructor MK 36 arms on land or water impact and is effective in water depths up to 60 feet. This is the only mine-like weapon that does not require a minimum water depth for arming. It is equally effective on land as well as in the water due to the sensitivity of the magnetic detector. (10 gauss). The sensitivity was established from measurements on South Vietnamese watercraft of lengths from 10 to 70 feet.																				
REMARKS a/ In Aug 1966, a development effort was initiated to provide a weapon with mine-like characteristics for use in the inland waterways of North Vietnam. The objective of the initial development effort is to provide a relatively simple weapon of high reliability, easily delivered by high performance aircraft, in as short a time as possible. The result of this effort is the Destructor MK 36, a weapon that has the external appearance of a conventional bomb which has the internal functions of a mine. b/ CINCPAC, in msg R220215Z Mar 67, established a requirement for 5000 destructor MK 36 units per month commencing with mid-summer 1967. Forthcoming issues of CINCPAC munition requirements will contain this information. Further, since the mine can be used for land interdiction as well as a water mine, CINCPAC states that "this requirement may be increased by a substantial amount." CINCPAC requested production items be consigned on a 5 to 1 ratio to CINCPACFLT and CINCPACAF, respectively. c/ Present stock (as of 2 Mar 67) of MK 82 bomb cases with MK 15 SNAKEYE fins in Southeast Asia is: <table border="1"> <tr> <td>USMC</td> <td>73,043 serviceable</td> <td>Navy</td> <td>50,000 per month</td> </tr> <tr> <td>USAF</td> <td>44,378 "</td> <td>CINCPAC</td> <td>20,000 per month</td> </tr> <tr> <td>USAF (Guam)</td> <td>20,000 "</td> <td></td> <td></td> </tr> </table>			USMC	73,043 serviceable	Navy	50,000 per month	USAF	44,378 "	CINCPAC	20,000 per month	USAF (Guam)	20,000 "								
USMC	73,043 serviceable	Navy	50,000 per month																	
USAF	44,378 "	CINCPAC	20,000 per month																	
USAF (Guam)	20,000 "																			

~~SECRET~~

MUNITIONS AVAILABLE FOR SOUTHEAST ASIA

AFTER FY 68

MUNITIONS DISPENSERS a/

CBU-33A.....Ejector Sys
TFDM-AP.....Ejector Sys
TFDM-MP.....Ejector Sys
TFDM-Frag.....Ejector Sys
ROCKEYE II....Cluster Bomb
DENEYE I, II..Cluster Bomb

DISPENSED SUBMUNITIONS b/

BLU-45/B.....Anti-vehicle land mine
BLU-46/B.....Bomblet
BLU-47/B.....Bomblet
BLU-48/B.....Bomblet
Mk 118 MOD.....Anti-Armor Bomblet

MISSILES c/

AGM-12E	BULLPUP (See AGM-12C)
AGM-53A	CONDOR
AGM-65A	MAVERICK
AIM-47A	FALCON
AIM-54A	PHOENIX
YRIM-66 A-1	SM-1 (MR)
YRIM-66	SM-1A (MR)
YRIM-67 A	SM (ER)

- a/ See tables 69 through 74
b/ See tables 75 through 79
c/ See tables 80 through 85

TABLE 69



MUNITIONS DATA SHEET		DISPENSED MUNITIONS															
DESIGNATION MODEL CBU-33/A NAME IPDM-AVLM g/ SERVICE USAF MANUF.		CATEGORY DISPENSING SYSTEM Air-Launched TARGETS Area denial		PHYSICAL CHARACTERISTICS LENGTH 139.7 in DIAMETER 15.3 in (width) SPAN 16.5 in (height) HEIGHT													
WEAPON CHARACTERISTICS WARHEAD 30 BLU-45/B AVLM g/ FILLER 4 lb HXA-3 per AVLM FUZING Magnetic KILL MECH. Blast, spalling, fragmentation LETHAL AREA		PERFORMANCE CHARACTERISTICS RANGE ALTITUDE FLIGHT TIME ACCURACY P _K (SINGLE SHOT)															
LAUNCH CHARACTERISTICS SUSPENSION DELIVERY MODE RELEASE MODE LIMITATIONS		USING AIRCRAFT F-100 F-105 F-4C F-111 A-7A															
DISPENSER DATA SUU-36/A is the IPDM dispenser configuration carrying 3 AVLM per bay for a total of 30.		FUZES		STATUS Development AVAILABILITY <table border="1"> <tr> <td>DATE</td> <td></td> <td></td> <td></td> <td></td> <td></td> </tr> <tr> <td>NO</td> <td></td> <td></td> <td></td> <td></td> <td></td> </tr> </table>		DATE						NO					
DATE																	
NO																	
OPERATING SEQUENCE																	
REMARKS g/ Anti-Vehicle Land Mine <div style="display: flex; justify-content: space-around;"> <div style="text-align: center;">  <p>AVLM</p> </div> <div style="text-align: center;">  <p>BLU-45/B</p> </div> </div>																	

TABLE 70

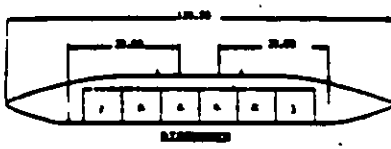
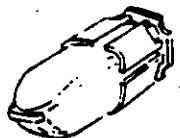

MUNITIONS DATA SHEET		DISPENSED MUNITIONS															
DESIGNATION MODEL CBU- NAME TFDM-AP A/ SERVICE USAF MANUF.		CATEGORY DISPENSING SYSTEM TARGETS Area coverage Anti-personnel															
		PHYSICAL CHARACTERISTICS LENGTH 139.7 in L/ DIAMETER 15.3 in (wide) SPAN 16.5 in (high) WEIGHT 820 lb															
WEAPON CHARACTERISTICS COPRAM Item WARHEAD 3840 BLU-46/B TFDMAP Grenades FILLER RDX FUZING Impact KILL MECH. Fragmentation LETHAL AREA		PERFORMANCE CHARACTERISTICS RANGE ALTITUDE FLIGHT TIME ACCURACY P _K (SINGLE SHOT)															
LAUNCH CHARACTERISTICS SUSPENSION 15" and 30" lugs L/ DELIVERY MODE Low level, high speed RELEASE MODE Variable, preset on ground LIMITATIONS 200 Kts (min), 800 Kts (max) & g's Designed for supersonic carriage & release		USING AIRCRAFT F-100 F-105 F-4C F-111 A-7A															
DISPENSER DATA SUU-37/A 10 bays, each with 8 manifolds having 48 AP grenades/manifold. Each manifold is cylindrical with stabilizing fins and drag vanes deployed at ejection. Each manifold has 4 expulsa tubes (12 grenades each). Impact ejects grenades 10 lb manifold.		FUZES STATUS Development															
		AVAILABILITY <table border="1"> <tr> <td>DATE</td> <td></td> <td></td> <td></td> <td></td> <td></td> <td></td> </tr> <tr> <td>NO</td> <td></td> <td></td> <td></td> <td></td> <td></td> <td></td> </tr> </table>		DATE							NO						
DATE																	
NO																	
OPERATING SEQUENCE At impact, the open manifold ejects 12 grenades from each of the 4 expulsion tubes to cover a wide area.																	
REMARKS A/ Tactical Fighter Dispenser Munition Anti-Personnel B/ Tapered nose and tail sections removable for in-line MGR carriage																	

TABLE 71

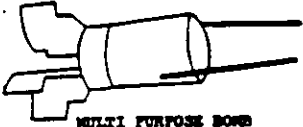
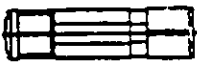
MUNITIONS DATA SHEET		DISPENSED MUNITIONS	
DESIGNATION MODEL CBU- NAME TFDN-MP <i>A/</i> SERVICE USAF MARKING		CATEGORY DISPERSED TARGETS Area coverage Anti-material, armor, and personnel	
WEAPON CHARACTERISTICS <i>COPYRAM Item</i> WARHEAD 1200 BLU-47/B TDFDMP Grenades FILLER FUZING Impact KILL MECH. Shaped charge and fragmentation LETHAL AREA		PHYSICAL CHARACTERISTICS LENGTH 139.7 in DIAMETER 15.3 in (wide) SPAN 16.5 in (height) WEIGHT 750 lb	
LAUNCH CHARACTERISTICS SUSPENSION 14" lug and 30" lugs DELIVERY MODE Low level, high speed RELEASE MODE Variable, preset on ground LIMITATIONS 200 Kts (min), 800 Kts (max) 4 g's		PERFORMANCE CHARACTERISTICS RANGE ALTITUDE FLIGHT TIME ACCURACY P _K (SINGLE SHOT)	
DISPENSER DATA SUU-37/A - 10 bays, each with 6 manifolds having 1200 grenades		USING AIRCRAFT F-100 F-105 F-4C F-111 A-7A	
FUZES		STATUS Development	
		AVAILABILITY DATE NO	
OPERATING SEQUENCE At impact, the open manifold ejects 12 grenades from each of the expulsion tubes to cover a wide area. Grenades detonate at the feeler stand-off distance.			
REMARKS <i>A/ Tactical Fighter Dispenser Munition-Multi-purpose</i>			
 <p>DISPENSER</p>		 <p>MANIFOLD OPEN</p>	
 <p>MULTI PURPOSE BOMB</p>		 <p>MANIFOLD STORED</p>	

~~SECRET~~

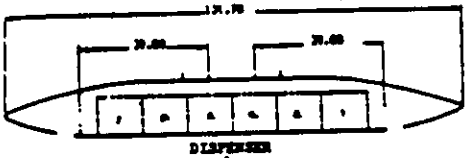
TABLE 72

MUNITIONS DATA SHEET		DISPENSED MUNITIONS																			
DESIGNATION MODEL CBU- NAME TFDM Frag Bomblet SERVICE USAP MANUF.		PHYSICAL CHARACTERISTICS LENGTH 139.7 in DIAMETER 15.3 in (width) SPAN 16.5 in (height) WEIGHT 750 lb																			
WEAPON CHARACTERISTICS WARHEAD 2000 BLU-88/B FILLER HE FUZING KILL MECH. Blast and fragmentation LETNAL AREA		PERFORMANCE CHARACTERISTICS RANGE ALTITUDE FLIGHT TIME ACCURACY P _K (SINGLE SHOT)																			
LAUNCH CHARACTERISTICS SUSPENSION DELIVERY MODE RELEASE MODE LIMITATIONS		USING AIRCRAFT F-100 F-105 F-4C F-111 A-7A																			
DISPENSER DATA SUD-37/A carries approx. 250 per bay.	FUZES	STATUS <table border="1"> <tr> <th colspan="6">AVAILABILITY</th> </tr> <tr> <th>DATE</th> <td></td> <td></td> <td></td> <td></td> <td></td> </tr> <tr> <th>NO</th> <td></td> <td></td> <td></td> <td></td> <td></td> </tr> </table>		AVAILABILITY						DATE						NO					
AVAILABILITY																					
DATE																					
NO																					
OPERATING SEQUENCE																					
REMARKS <div style="text-align: center;">  <p>DISPENSER</p>  <p>BLU-88/B</p> </div>																					

~~SECRET~~

EB-11d

Table 72 to
Annex B to
Appendix E

TABLE 73



MUNITIONS DATA SHEET		DISPENSED MUNITIONS	
DESIGNATION MODEL <u>MX-20</u> Cluster Bomb NAME <u>ROCKEYE II</u> SERVICE <u>USM</u> MANUF.		CATEGORY CLUSTER Air-to-surface TARGETS Anti-tank/vehicles Anti-personnel	
WEAPON CHARACTERISTICS WARHEAD 247 shaped charge bomblets g/ FILLER FUZING Time (cluster), impact (bomblet) KILL RECM. Blast, fragmentation and spalling LETHAL AREA		PHYSICAL CHARACTERISTICS LENGTH 91.0" DIAMETER 13.0" SPAN 28.0" WEIGHT 500# PERFORMANCE CHARACTERISTICS RANGE ALTITUDE FLIGHT TIME ACCURACY P _R (SINGLE SHOT)	
LAUNCH CHARACTERISTICS SUSPENSION 14" lugs DELIVERY MODE Dive/glide, 300 ft level RELEASE MODE Stick or single LIMITATIONS 600 kts		USING AIRCRAFT F-100 F-105 F-4C F-111 B-57 B-26 A-7A	
DISPENSER DATA ROCKEYE II uses the MK7 Mod 0 segmented clamshell which hinges at the rear and has canted folding fins. Time fuze activates cutter to allow bombs to disperse.		FUZES M907 mechanical timer MK399 mechanical timer	
		STATUS ANAL. ABILITY DATE NO	
OPERATING SEQUENCE			
REMARKS g/ Fin stabilized, 2.2" diameter, MK118 Mod 0 anti-tank bomblet			
			

TABLE 74

MUNITIONS DATA SHEET		DISPENSED MUNITIONS	
DESIGNATION MODEL NAME DENEYE I, II SERVICE USN/Tri-Service MANUF.		CATEGORY Air-to-surface TARGETS Area denial anti-tank mine (I) and anti-personnel mine(II)	
		PHYSICAL CHARACTERISTICS LENGTH DIAMETER SPAN WEIGHT 18# Shape: Rectangular	
WEAPON CHARACTERISTICS WARHEAD Anti-tank Anti-personnel FILLER See Remarks b/ and d/ FUZING See Remarks b/ and d/ KILL MECH. LETNAL AREA		PERFORMANCE CHARACTERISTICS RANGE ALTITUDE FLIGHT TIME ACCURACY Pk (SINGLE SHOT) K-kill under tank belly; M-kill on tread	
LAUNCH CHARACTERISTICS SUSPENSION DELIVERY MODE RELEASE MODE LIMITATIONS		USING AIRCRAFT All USN/USM ftr/attack a/c	
DISPENSER DATA HOCKEY II MK7 Mod O dispenser or TFDN b/		FUZES DENEYE I: The TDD (Target detecting device) is highly selective and difficult to decoy	
		STATUS Engineering development g/ initiated FY66 g/ suspended FY66 Scheduled for inventory FY72 AVAILABILITY DATE NO	
OPERATING SEQUENCE Air delivered from high performance aircraft			
REMARKS g/ proj W-126, 6.42.06.06.2 b/ Final design not selected g/ Funding schedule, DENEYE I & II FY66 852K FY67 522K (\$1556 Cut) FY68 1,000K FY69 3,200K FY70 1,200K d/ DENEYE I Submittions: 18#, rectangular shaped anti-tank mine, linear shaped charge DENEYE II Submittions: 1.4#, 2" dia x 3" long, double truncated sphere, anti-personnel trip wire mine			
			

~~SECRET~~

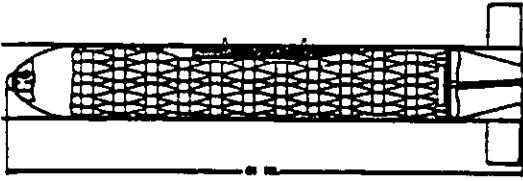
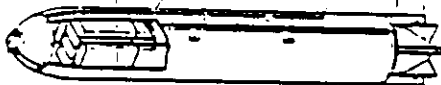
TABLE 75

MUNITIONS DATA SHEET		DISPENSED MUNITIONS															
DESIGNATION MODEL BLU-45/B NAME ALVM g/ SERVICE USAF MANUF. Honeywell		CATEGORY LAND MINE Air-to-Surface TARGETS All vehicles															
WEAPON CHARACTERISTICS WARHEAD Missay-Schardin shaped charge FILLER 4 lb HIA-3 FUZING Magnetic KILL MECH. Blast, fragments LETHAL AREA Armor Penetration, 8 ft crater		PHYSICAL CHARACTERISTICS LENGTH 18" (fin extended) DIAMETER 4" square SPAR WEIGHT 19.1 lb 14.25" (fin folded)															
LAUNCH CHARACTERISTICS SUSPENSION 14" lugs, ATLM Dispenser DELIVERY MODE Level, 1500 ft altitude RELEASE MODE Variable dispensing rate LIMITATIONS 800 min alt, 600 KIAS		PERFORMANCE CHARACTERISTICS RANGE ALTITUDE FLIGHT TIME ACCURACY P _R (SINGLE SHOT)															
DISPENSER DATA 8UU-36/A holds 30 units		USING AIRCRAFT F-100 F-4C F-105 F-111 A-7A															
FUZES Safetied from 0-4 seconds and after 45 seconds. Self-destruct at 24, 72 or 240 hours.		STATUS Eng'r Devel. Task 250703 Development: Sep 67 Production: Not yet contracted 6000 Dispenser per month approved by OSD															
AVAILABILITY <table border="1"> <thead> <tr> <th>DATE</th> <th>JUL</th> <th>AUG</th> <th>SEP</th> <th>OCT</th> <th>NOV</th> <th>DEC</th> </tr> </thead> <tbody> <tr> <td>NO</td> <td>6000</td> <td></td> <td></td> <td></td> <td></td> <td></td> </tr> </tbody> </table>				DATE	JUL	AUG	SEP	OCT	NOV	DEC	NO	6000					
DATE	JUL	AUG	SEP	OCT	NOV	DEC											
NO	6000																
OPERATING SEQUENCE Ejection sequence from 8UU-36/A bays. 1 to 10 in 30, 61, 92, 140, 200 or 300 milliseconds, preset before take off. Impact is nearly vertical and mine penetrates 3-4 ft, with dirt covering up crater.																	
REMARKS g/ Anti-Vehicle Land Mine																	

~~SECRET~~

EB-11g

Table 75 to
Annex B to
Appendix E

TABLE 76





MUNITIONS DATA SHEET		DISPENSED MUNITIONS	
DESIGNATION MODEL BLU-46/B NAME Anti-Personnel Grenade SERVICE USAF MANUF.		CATEGORY DISPENSED MUNITION TARGETS Area coverage Anti-personnel	
WEAPON CHARACTERISTICS COFRAN Item		PHYSICAL CHARACTERISTICS LENGTH 1.195 in DIAMETER 0.6 in SPAN WEIGHT 0.0968 (each) 10 lb (manifold)	
WEAPON CHARACTERISTICS WARHEAD FILLER RDX FUZING Contact KILL RECH. Fragmentation LETNAL AREA		PERFORMANCE CHARACTERISTICS RANGE ALTITUDE FLIGHT TIME ACCURACY Pk (SINGLE SHOT)	
LAUNCH CHARACTERISTICS SUSPENSION DELIVERY MODE RELEASE MODE LIMITATIONS		USING AIRCRAFT	
DISPENSER DATA SUU-37/A, 3840 grenades total 48 grenades per mani- fold, 8 manifolds per bay 10 bays total.		FUZES	
		STATUS AVAILABILITY DATE NO	
OPERATING SEQUENCE At impact, open manifold ejects bomblets over a wide area.			
REMARKS <div style="display: flex; justify-content: space-around; align-items: center;"> <div style="text-align: center;">  <p>ANTI-PERSONNEL BOMB</p> </div> <div style="text-align: center;">  <p>MANIFOLD OPEN</p>  <p>MANIFOLD STORED</p> </div> </div>			

TABLE 77

MUNITIONS DATA SHEET		DISPENSED MUNITIONS	
DESIGNATION MODEL RIU-47/B NAME Multi-purpose grenade SERVICE MARKS.		CATEGORY Dispensed Munition TARGETS Air-to-Surface Anti-materiel, personnel Anti-armor	
		PHYSICAL CHARACTERISTICS LENGTH 1.27" DIAMETER 1.32" SPAN WEIGHT 0.335#	
WEAPON CHARACTERISTICS COFRAM ITEM WARHEAD Conical shaped charge surrounded by fragmenting shell FILLER FUZING Impact KILL MECH. Blast & fragmentation LETHAL AREA		PERFORMANCE CHARACTERISTICS RANGE ALTITUDE FLIGHT TIME ACCURACY P _K (SINGLE SHOT)	
LAUNCH CHARACTERISTICS SUSPENSION DELIVERY MODE RELEASE MODE LIMITATIONS		USING AIRCRAFT	
DISPENSER DATA SUU-37/A contains 1280 grenades clustered in 10 manifolds		FUZES	
		STATUS Development	
		AVAILABILITY DATE NO	
OPERATING SEQUENCE At impact, open manifold ejects grenades over a wide area. After the grenade is expelled from the manifold stabilizing fins deploy along with stand-off legs which provide optimum standoff for the shaped charge.			
REMARKS <div style="text-align: center;">  <p>MULTI PURPOSE BOMB</p> </div> <div style="display: flex; justify-content: space-around; align-items: center;"> <div style="text-align: center;">  <p>MANIFOLD STORED</p> </div> <div style="text-align: center;">  <p>MANIFOLD OPEN</p> </div> </div>			

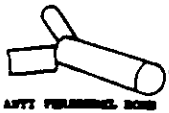
~~SECRET~~

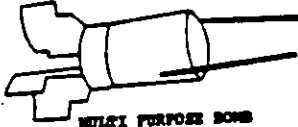
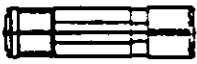
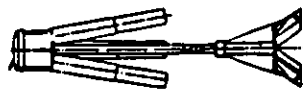
TABLE 78

MUNITIONS DATA SHEET		DISPENSED MUNITIONS																					
DESIGNATION MODEL BLU-48/B NAME FRAG JUNGLE BOMBLET SERVICE USAF MANUF. Honeywell		CATEGORY DISPENSED MUNITION AIR-TO-SURFACE TARGETS Area coverage																					
WEAPON CHARACTERISTICS WARHEAD FILLER FUZING Impact initiation, airburst detonation All terrain operation KILL MECH. Fragmentation LETAL AREA 25-30 ft		PHYSICAL CHARACTERISTICS LENGTH DIAMETER 1.5 in SPAN WEIGHT 0.25 lb																					
LAUNCH CHARACTERISTICS SUSPENSION DELIVERY MODE Level, shallow dive RELEASE MODE 5 Dispensing rates LIMITATIONS Mach 1.2		PERFORMANCE CHARACTERISTICS RANGE ALTITUDE FLIGHT TIME ACCURACY P _r (SINGLE SHOT)																					
DISPENSER DATA SUU-37/A (TFDM) will contain 2090 bomblets		USING AIRCRAFT All aircraft with 750 lb stations																					
FUZES Spin arm, spin decay Pop up (delay) detonation		STATUS Development Development: Comp. Fall 1967 Qualification: FY 68 Production: FY 69																					
AVAILABILITY <table border="1"> <tr> <td>DATE</td> <td></td> <td></td> <td></td> <td></td> <td></td> <td></td> <td></td> <td></td> <td></td> </tr> <tr> <td>NO</td> <td></td> <td></td> <td></td> <td></td> <td></td> <td></td> <td></td> <td></td> <td></td> </tr> </table>				DATE										NO									
DATE																							
NO																							
OPERATING SEQUENCE																							
REMARKS																							
																							

~~SECRET~~

EB-11j

Table 78 to
Annex B to
Appendix E

TABLE 79

MUNITIONS DATA SHEET		DISPENSED MUNITIONS	
DESIGNATION MODEL MK 118 Mod 0 NAME SERVICE IIGR MANUF.		CATEGORY Dispensed munition/Air-to-Surface TARGETS Anti-tank Anti-personnel	
		PHYSICAL CHARACTERISTICS LENGTH DIAMETER 2.2" SPAN WEIGHT	
WEAPON CHARACTERISTICS WARHEAD FILLER FUZING KILL MECH. LETHAL AREA		PERFORMANCE CHARACTERISTICS RANGE ALTITUDE FLIGHT TIME ACCURACY Pk (SINGLE SHOT)	
LAUNCH CHARACTERISTICS SUSPENSION DELIVERY MODE RELEASE MODE LIMITATIONS		USING AIRCRAFT	
DISPENSER DATA ROCKEYF II uses the MK7 Mod 0 universal dispenser with MK118 Mod 0 bombs		FUZES	
		STATUS AVAILABILITY DATE NO	
OPERATING SEQUENCE			
REMARKS 			

TABLE 80

MUNITIONS DATA SHEET		GUIDED MISSILES	
DESIGNATION		CATEGORY MISSILE	PHYSICAL CHARACTERISTICS
MODEL	AGM-53AB ^{a/}	A: R-to-Surface TARGETS	LENGTH 166 in
NAME	CONDOR	Fixed or mobile point targets	DIAMETER 17 in
SERVICE	USN		SPAN 53 in
MANUF.	Martin		WEIGHT 1873 lb
WEAPON CHARACTERISTICS		PERFORMANCE CHARACTERISTICS	
WARHEAD	17dx10, 630 lb ^{b/}	RANGE	35 - 64 NM
FILLER	Comp B, 17dx40 ^{c/}	ALTITUDE	2000 - 40000 ft
FUZING		SPEED	Mach 3 - 6
KILL MECH.	Blast & Frag	FLIGHT TIME	
LETHAL AREA		ACCURACY	10 ft CEP
		P _K (SINGLE SHOT)	
LAUNCH CHARACTERISTICS		USING AIRCRAFT	
SUSPENSION		A-6A	
DELIVERY MODE		A-7A	
RELEASE MODE		Continuous missile video data recorded on 16mm film in aircraft pod.	
LIMITATIONS		Pod wt 460 lb, 115" long, 17 diameter	
SAFED	Mach.5 -.9		
GUIDANCE	PROPULSION	STATUS	DEVELOPMENT
PRELAUNCH	TYPE Liquid rocket, prepack- ed dual thrust g/	DEVELOPMENT	1st launch 4Q FY 68
BOOST	MODEL	QUALIFICATION	MTE 3Q FY 69
MIDCOURSE	THRUST 700 lb 1400 lb	OPERFOR	4Q FY 69
TERMINAL	150,000 lb-sec total impulse 300 sec coast between burns avail.	PRODUCTION	10C 3Q FY 70 g/
		Schedule not yet established	
		AVAILABILITY	
		DATE	
		NO.	
OPERATING SEQUENCE			
Heading, initial and final cruise altitude, and engine thrust programmed before launch. Command guidance via data link during flight. TV/command guidance during terminal phase.			
REMARKS			
^{a/} Formerly ASM-N-11 ^{b/} CSCF (combined shape charge and frag) with 8 pt linear shaped charge ^{c/} PBKN-101 acceptable alternate ^{d/} Est. production cost is \$60-65,000 ^{e/} Prepackaged, fuel and oxidizer in separate aluminum bladders. Demand type gas generators for P/O expulsion. Chlorine Trifluoride (CTF), mixed hydrazine fuel (MHP-3), 700 psia chamber pressure.			

TABLE 81

MUNITIONS DATA SHEET		GUIDED MISSILES	
DESIGNATION		CATEGORY	PHYSICAL CHARACTERISTICS
MODEL AGM-65A		Air-to-Surface TARGETS	LENGTH 74 in
NAME MAVERICK		Structure ARM	DIAMETER 10 in
SERVICE USAF			SPAN 31 in
MANUF. Hughes (NAA)			WEIGHT 364 lb
WEAPON CHARACTERISTICS		PERFORMANCE CHARACTERISTICS	
WARHEAD Conical shaped charge, 200 lb		RANGE	
FILLER 88 lb comp-b		ALTITUDE	
FUZING contact		FLIGHT TIME	
KILL MECH. Blast and fragmentation		ACCURACY	
LETHAL AREA		P_R (SINGLE SHOT)	
LAUNCH CHARACTERISTICS		USING AIRCRAFT	
SUSPENSION MAU-12B/A with adapter or sidevinder type launch rail		F-105	
DELIVERY MODE Dive		F-4C	
RELEASE MODE		F111	
LIMITATIONS			
GUIDANCE	PROPULSION	STATUS DEVELOPMENT	
PRELAUNCH TV Locked on	TYPE Solid rocket		
BOOST TV	MODEL		
MIDCOURSE TV	THRUST		
TERMINAL TV			
		AVAILABILITY	
		DATE	
		NO.	
OPERATING SEQUENCE Television contrast tracker is locked on target and missile launched. Gated video contrast tracks provides automatic guidance.			
REMARKS			

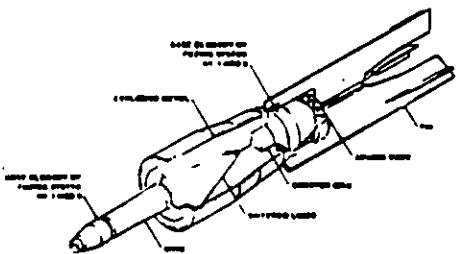
TABLE 82

MUNITIONS DATA SHEET		GUIDED MISSILES	
DESIGNATION MODEL AIM-47A <input checked="" type="checkbox"/> <input checked="" type="checkbox"/> NAME SERVICE USAF MANUF. Hughes (Model 50)		CATEGORY Air-to-air TARGETS Aircraft	
		PHYSICAL CHARACTERISTICS LENGTH 150.5 in DIAMETER 13.5 in SPAN 33.0 in WEIGHT	
WEAPON CHARACTERISTICS WARHEAD FILLER FUZING Proximity KILL MECH. LETMAL AREA		PERFORMANCE CHARACTERISTICS RANGE ALTITUDE FLIGHT TIME ACCURACY P _K (SINGLE SHOT)	
LAUNCH CHARACTERISTICS SUSPENSION DELIVERY MODE RELEASE MODE LIMITATIONS		USING AIRCRAFT YF-12A	
GUIDANCE PRELAUNCH BOOST MIDCOURSE Semi-act radar homing TERMINAL Semi-active radar homing		PROPULSION TYPE Solid rocket, single level MODEL XSR-13-LP-1 THRUST 18440 lb (max) Avg: 16410 lb/3.46 sec impulse: 57,874 lb -sec isp=233 lb-sec 1 lb	
		STATUS DEVELOPMENT <input checked="" type="checkbox"/> Production - Not authorized yet AVAILABILITY DATE NO.	
OPERATING SEQUENCE Missile seeker tracks doppler shifted ASG-18 radar energy reflected from target. Tracking head mounted on free gyro provides proportional navigation steering signals to acceleration control system.			
REMARKS <input checked="" type="checkbox"/> Formerly GAR-9 (System 202A) <input checked="" type="checkbox"/> An AIM-47A/SHRIKE II proposal would provide an anti radar homing capability with a P _K =0.7 <input checked="" type="checkbox"/> Primary armament of the YF-12A/ASG-18 weapon system, but is compatible with a variety of other interceptors.			

~~SECRET~~

TABLE 83

MUNITIONS DATA SHEET		GUIDED MISSILES											
DESIGNATION MODEL AIM-54A [▲] NAME PHOENIX SERVICE USN MANUF. Hughes		CATEGORY Air-to-air TARGETS Aircraft											
		PHYSICAL CHARACTERISTICS LENGTH 156 in DIAMETER 15 in SPAN 36 in WEIGHT 1000 lbs											
WEAPON CHARACTERISTICS WARHEAD FILLER HE FUZING Proximity KILL MECH. LETHAL AREA		PERFORMANCE CHARACTERISTICS RANGE 80 miles (detection) 50 miles (aero range) ALTITUDE SL-80000 ft. FLIGHT TIME ACCURACY P _r (SINGLE SHOT)											
LAUNCH CHARACTERISTICS SUSPENSION DELIVERY MODE RELEASE MODE Nearly simultaneous launch at six missiles vs. six separate lgts. LIMITATIONS		USING AIRCRAFT F-111B											
GUIDANCE PRELAUNCH Pulse-doppler BOOST MIDCOURSE Semi-active TERMINAL Active		PROPULSION TYPE Solid Rocket MODEL THRUST											
		STATUS PRODUCTION AVAILABILITY <table border="1"> <tr> <td>DATE</td> <td>FY68</td> <td>FY69</td> <td>FY70</td> <td>FY71</td> </tr> <tr> <td>NO.</td> <td>360</td> <td>360</td> <td>360</td> <td>360</td> </tr> </table>		DATE	FY68	FY69	FY70	FY71	NO.	360	360	360	360
DATE	FY68	FY69	FY70	FY71									
NO.	360	360	360	360									
OPERATING SEQUENCE													
REMARKS ▲ Formerly AAM-N-11													

~~SECRET~~

EB-110

Table 83 to
Annex B to
Appendix E

TABLE 84

MUNITIONS DATA SHEET		GUIDED MISSILES	
DESIGNATION MODEL SM-1A (MR) SM-1 (MR) YRIM-66A-1 YRIM-66 () NAME TARTAR SERVICE IIGN MANUF. GD/POMONA		CATEGORY Surface-to-air and TARGETS surface AIR SURFACE Aircraft Ships Missiles	
		PHYSICAL CHARACTERISTICS LENGTH 176" for jboth DIAMETER 13.5" for both SPANDorsal 23" for both Tail 42.6" for both WEIGHT 1240# for the SM-1A 1600# for the SM-1	
WEAPON CHARACTERISTICS WARHEAD HE continuous rod FILLER FUZING Proximity and contact KILL MECH. Blast and fragmentation LETHAL AREA		PERFORMANCE CHARACTERISTICS SM-1A SM-1 RANGE (max) 17.5NM 25nm (min) 2000 yd 1000 yd ALTITUDE (max) 65 K' 89 K' (min) Surface Surface FLIGHT TIME ACCURACY P _z (SINGLE SHOT) 0.6	
LAUNCH CHARACTERISTICS SUSPENSION MK11, MK13, or MK22 Launcher DELIVERY MODE RELEASE MODE LIMITATIONS		USING CRAFT Small ships: DDC DLG	
GUIDANCE PRELAUNCH BOOST MIDCOURSE Semi-active homing X-Band CW TERMINAL Semi-active homing X-Band CW		PROPULSION SM-1A SM-1 TYPE Solid Propel- 90" DTRM LAST DTRM MODEL THRUST STATUS See inventory and production schedules on RIM-24 series AVAILABILITY DATE NO.	
OPERATING SEQUENCE Launch into WE illuminating radar beam and home on reflected energy from target			
REMARKS			

TABLE 85

MUNITIONS DATA SHEET		GUIDED MISSILES															
DESIGNATION RIM-2 Series MODEL SM (ER) <u>a/</u> YRIM-67A NAME TERRIER SERVICE MANUF. General Dynamics/Pomona		CATEGORY MISSILE, Surface to TARGETS air Aircraft Missiles PHYSICAL CHARACTERISTICS LENGTH 150 inches DIAMETER 13.5 inches SPAN (fin) 23 inches (tail) 42.6 inches WEIGHT															
WEAPON CHARACTERISTICS WARHEAD HE Continuous Rod FILLER FUZING Influence KILL MECH. LETHAL AREA		PERFORMANCE CHARACTERISTICS RANGE (Max) 40 NM (Min) 8,000 yd ALTITUDE (Max) 80,000 ft (Min) 50 ft FLIGHT TIME ACCURACY P_r (SINGLE SHOT) 0.6															
LAUNCH CHARACTERISTICS SUSPENSION DELIVERY MODE RELEASE MODE LIMITATIONS		USING CRAFT Frigates Cruisers Aircraft Carriers															
GUIDANCE PRELAUNCH BOOST Wing control to capture MIDCOURSE Beam riding pulsed TERMINAL X-Band CW Semi-active homing		PROPULSION Solid propellant booster and sustainer TYPE MODEL THRUST STATUS INVENTORY Current RT missile in use will be followed by this SM (ER) with production below <u>a/</u> AVAILABILITY <table border="1"> <tr> <th>DATE</th> <th>PY67</th> <th>PY68</th> <th>PY69</th> <th>PY70</th> <th>PY71</th> <th>PY72</th> </tr> <tr> <td>NO</td> <td>580</td> <td>560</td> <td>560</td> <td>530</td> <td>600</td> <td>450</td> </tr> </table>		DATE	PY67	PY68	PY69	PY70	PY71	PY72	NO	580	560	560	530	600	450
DATE	PY67	PY68	PY69	PY70	PY71	PY72											
NO	580	560	560	530	600	450											
OPERATING SEQUENCE Missiles are launched into X-Band CW intercept beam and home on the energy reflected from the target.																	
REMARKS <u>a/</u> SM (ER) - Standard Missile (Extended Range) (YRIM-67A)																	

PRODUCTION SCHEDULES FOR SELECTED MUNITIONS a/

Mk-84
M-118
CBU-24/29
AGM-45 (SHRIKE)
AGM-62 (WALLEYE)
5" Gun & Spin Stabilized Rockets

a/ See tables 86 and 87

EB-12

Annex B to
Appendix E

TABLE 86

AUTHORIZATION FOR PRODUCTION AND EXPENDITURE

1967

	K	A	M	L	I	A	S	E	H	D	L	E	M
MLC-24 A /													
PRODUCTION													
FACON ALLOCATION	940	1040	1240	1440	2200	2950	3910	5030	5750	7490	7860	8000	8000
EXPENDITURE	600	625	1100	1300	1475	1600	1900	2100	2100	2100			
DELIVERY RIGHT	500	500	1300	1700	1700	1700	2100	2075	2775	2100			
FACON REQUIREMENT													
EXPENDITURE	8050	8050	8050	8050	8050	8050	8050	8050	8050	8050	8050	8050	8050
DELIVERY RIGHT	9375	10500	10500	10450	9450	8550	8450	8050	8050	8050	8050	8050	8050
DEFICIT	7550	7550	6750	6350	6350	6350	5950	5975	5275	5950			
MLC-24 B /													
PRODUCTION													
FACON ALLOCATION													
EXPENDITURE	107036	110457	111257	111257	114050	114050	114050	114435	114435	114435			
DELIVERY RIGHT	95800	116300	121600	113200	117930	114430	121200	125900	127100	124100			
FACON REQUIREMENT													
EXPENDITURE	93977	93977	93977	93977	96774	96774	96774	97155	97155	97155			
DELIVERY RIGHT	60784	87189	93977	93977	96774	96774	96774	96255	97155	97155			
DEFICIT	+1823	+22223	+27623	-19223	+21156	-17656	+24426	+29645	+26949	+16945			
MLC-24 C /													
PRODUCTION													
FACON ALLOCATION													
EXPENDITURE	55	55	55	55	55	55	55	75	170	220			
DELIVERY RIGHT	0	0	0	0	0	0	0	0	300	500			
FACON REQUIREMENT													
EXPENDITURE	75	75	75	75	75	75	75	95	170	220			
DELIVERY RIGHT	0	0	0	0	0	0	0	0	300	500			
DEFICIT	75	75	75	75	75	75	75	95	+130	+280			
MLC-24 D /													
PRODUCTION													
SEA STOCK	0	0	0	0	0	0	0	0	0	0			
FACON ALLOCATION	5694	5426	5158	4840	4622	4380	4138	3896	3680	3464			
STOCK	400	400	400	400	400	400	400	400	400	400			
EXPENDITURE	268	268	268	268	268	268	268	216	216	216			
DELIVERY RIGHT	0	0	0	0	0	0	0	0	0	0			
FACON REQUIREMENT													
EXPENDITURE	268	268	268	268	268	268	268	216	216	216			
DELIVERY RIGHT	0	0	0	0	0	0	0	0	0	0			
DEFICIT	268	268	268	268	268	268	268	216	216	216			
MLU-31 D A /													
PRODUCTION													
FACON ALLOCATION						200	200	200	200	200	200	200	200
EXPENDITURE	20	20	20	20	20	20	20	20	20	20	20	20	20
DELIVERY RIGHT	0	0	0	0	0	0	0	0	200	200	200	200	200
FACON REQUIREMENT													
EXPENDITURE	1500	1500	1500	1500	1500	1500	1500	1500	1500	1500	1500	1500	1500
DELIVERY RIGHT	1500	1500	1500	1500	1500	1500	1500	1500	1500	1500	1500	1500	1500
DEFICIT	1500	1500	1500	1500	1500	1500	1500	1500	1300	1300	1300	1300	1300
AGM-45 CHARLIE E /													
PRODUCTION													
FACON ALLOCATION	291	311	335	350	415	450	550	700	850	850	850	850	850
EXPENDITURE	270	270	310	330	350	350	350	350	350	350	350	350	350
DELIVERY RIGHT	271	271	311	325	350	350	350	350	350	350	350	350	350
FACON REQUIREMENT													
EXPENDITURE	600	600	600	600	600	600	600	600	600	600	600	600	600
DELIVERY RIGHT	600	600	600	600	600	600	600	600	600	600	600	600	600
DEFICIT	329	329	289	275	150	150	150	150	150	150	150	150	150
MLU MOD U WALLEYE E /													
PRODUCTION													
FACON ALLOCATION	76	166	166	236	288	324	350	420	450	500	500	500	500
EXPENDITURE	82	64	50	100	100	100	100	100	100	175	175	175	175
DELIVERY RIGHT													
FACON REQUIREMENT													
EXPENDITURE	200	200	200	600	600	600	600	600	600	600	600	600	600
DELIVERY RIGHT													
DEFICIT	124	36	36	364	312	276	250	180	150	100	100	100	100

- A/ CBU-24 is severely rationed and is considered to be one of the most critical supply items. Production is increasing but stocks will not be adequate for CINCPAC's desired expenditure of 8050 per month during calendar 1967. The delivery requirement allows build-up of stockpile to 12,050 (45 day stock); however, actual deliveries will allow a stockpile level of only 425. Further acceleration of production is recommended, especially in view of potential requirements which might be established by PRACTICE RISE.
- B/ This is a 500 pound general purpose bomb
- C/ This is a 2,000 pound general purpose bomb
- D/ This is a 3,000 pound general purpose bomb, no longer in production. Existing stocks are rationed.
- E/ The MLU-31 is a 750 pound penetration bomb/mine equipped with the FPU-30/B fuse
- F/ The desired expenditure is 600 per month. Also see entry for STANDARD ARM, page EB-10M, TABLE 67.
- G/ The deficit does not include weapons necessary to build up to a stock level objective of 900 (45 day supply).
- H/ This deficit is estimated on production figures since delivery requirements are not available.

ANNEX C TO APPENDIX E

NAVIGATION AND SENSORS

1. (U) General

a. For an aircraft to be an effective weapon the pilot must be able to navigate to a precise point to deliver weapons, operate reconnaissance sensors, or carry out other flight operations. This annex will specifically address the constraints navigation plays on using weapon delivery and recon sensors, and will tabulate available and development navigation systems and sensors applicable to this study.

b. The fundamental problem in precise weapon delivery and recon operations is locating the target from the air. No matter how well the target is located on a chart or photograph, it still must be found again in a coordinate system relative to the aircraft. Operations at night, in weather, over water and jungles, and in mountainous areas complicate this problem tremendously, so much in fact, that various auxiliary sensors are a mandatory part of any modern airborne weapon system.

Table 4 at the end of this section, page EC-12c, provides a summary of the sensors by types. With the exception of the inertial and air data systems, a suitable computer, weapon delivery can be accomplished as well as DR navigation. The presentation for an air-to-air radar is usually a blip from which the operator can determine relative elevation as well as relative bearing and range of the target. With a suitable computer, air-to-air weapon delivery can also be accomplished.

c. Because of technical restrictions, it has been necessary to optimize airborne radar, for either the air-to-air role or the air-to-ground role. Consequently, an air-to-air radar usually provides a poor ground mapping capability, and vice versa. Current developments in multi-mode radar are designed to overcome this problem.

d. The accuracy of a radar system is inherently limited by its antenna beam width, the transmitted pulse length, and cathode ray tube spot size. Current fighter radars which have about a three degree beam width cannot resolve targets which are less than about 50 mils or one-half mile at 10 miles range. While smaller targets may be detected, their relative size becomes indeterminate, thus complicating target recognition and acquisition. The technique of doppler beam sharpening, which all use electromagnetic energy in some form, and are thus basically range limited. Consequently for these sensors to be of value, the target must be within range as well as within line-of-sight. The maximum useful range of the sensor thus defines a target gate into which the aircraft must enter if the sensor is to be able to see the target. The range of weapon release defines a minimum range with respect to the target. Between these two ranges the target must be detected, recognized, and acquired (DRA). The pilot must then maneuver the aircraft to converge on the release point and be in the correct delivery attitude at release. The time required to accomplish this sequence of activities defines the minimum acceptable target gate for a particular sensor, which in turn defines the navigation system accuracy required. Thus the navigation/sensor combination must be considered together. This is especially true of short range sensors such as LLLTV and FLIR.

e. There are obviously some alternatives to this dilemma. First, the aircraft can fly slow to increase the time available. Second, a homing device can be used to compensate for errors in arriving at the correct release point. Third, downward or rearward weapon trajectories might be used. Also using a second man to operate the weapon delivery system can reduce the burden on an individual pilot. This latter factor is especially true for night or all weather operations when flying the aircraft is a full time job.

f. Most of this also applies to armed reconnaissance tactics. Should a target of opportunity be found by the sensor, the problems of DRA and converting the attack still exist. Even tactics for making a second

~~CONFIDENTIAL~~

pass at the target (assuming DRA on the first pass) will still require a system to remember the target location and a highly accurate short term navigation system to bring the aircraft back in position to attack the target.

g. For military use the most desirable type of navigation system is one that is completely self-contained in the aircraft, that is, it does not need to rely on ground radio transmission or other external references. It is also desirable in many instances to have a passive or semi-passive system (i.e., one that does not radiate). However, the overriding criteria is still accuracy, that is, sufficient accuracy to put the aircraft within the target gate of the target sensor. The following paragraphs discuss current and projected navigation/sensor systems with respect to the criteria just outlined.

2. (C) Inertial Navigation Systems

a. A completely self-contained, passive system which can provide excellent short term navigation position, heading, vertical, and velocity information. However, it has a characteristic oscillating error in all channels which contributes a substantial uncertainty in the absolute values. In addition, the position and heading loops are a function of gyro drift which causes the error rate to increase. Thus, position error is approximately proportional to the square of the time since alignment. In most inertial systems a read-out of instantaneous velocity is not available, and the computed velocity is not accurate enough for weapons delivery.

b. Several developmental approaches are being taken to compensate for the position and velocity error build up in pure inertial navigation systems. The F-111A Mark II navigation system will incorporate advanced computer routines to process the inertial system data along with external position and velocity reference data. This optimal filtering technique will bound the system errors to values better than any of the individual system errors. Other approaches, now in advanced development, will integrate, various combinations of

~~CONFIDENTIAL~~

EC-3

Annex C to
Appendix E

celestial, radio, inertial, and doppler radar techniques along with optimal filtering to achieve an integrated navigation/weapon delivery capability.

c. The following table lists current and development inertial navigation systems and some performance characteristics:

<u>SYSTEM</u>	<u>AIRCRAFT</u>	<u>DATA SOURCE</u>	<u>POSITION ERROR</u>	<u>VELOCITY ERROR</u>
ASN-48	F-4C	Oper	6nm/hr	30fps
ASN-48	F-4C	Test	3.5nm/hr	
ASN-48(MOD)	F-4C	Test	2.5nm/hr	
ASN-56	RF-4C	Test	1.9nm/hr	
AJQ-20	F-111A(MKI)	Goal	2nm/hr	
AJN-14	F-111B	Goal	2nm/hr	
AJN-14	F-111B	Test	1.8nm/hr	8fps
ASN-47	F-106	Test	0.9nm/hr	3fps
N-16	F-111A(MK2)	Test	0.9nm/hr	3fps

3. (C) Airborne Radar

a. Airborne radar systems vary considerably according to their particular functions, which include air-to-air, ground mapping, vertical navigation, ground speed determination, beaconry for station keeping and IFF, and missile guidance. Table 5, page EC-12d, summarizes the basic types and functions of airborne radar systems.

b. Forward-looking airborne radar (FLAR) is a self-contained actively radiating system which presents the radar returns to the operator on a cathode ray tube. The ground presentation may be either a slant range or a ground range radar map of the area being scanned. The operator must interpret the scope picture to locate the target. Once located, the relative bearing and range of the target with respect to the aircraft can be measured. With a suitable computer, air-to-ground weapon delivery can be accomplished as well as DR navigation. The presentation for an air-to-air radar is usually a blip from which the operator can determine relative elevation

as well as relative bearing and range of the target. With a suitable computer, air-to-air weapon delivery can also be accomplished.

c. Because of technical restrictions, it has been necessary to optimize airborne radars for either the air-to-air role or the air-to-ground role. Consequently, an air-to-air radar usually provides a poor ground mapping capability, and vice versa. Current developments in multi-mode radar are designed to overcome this problem.

d. The accuracy of a radar system is inherently limited by its antenna beam width, the transmitted pulse length, and cathode ray tube spot size. Current fighter radars which have about a three degree beam width cannot resolve targets which are less than about 50 mils or one-half mile at 10 miles range. While smaller targets may be detected, their relative size becomes indeterminate, thus complicating target recognition and acquisition. The technique of doppler beam sharpening, which just finished the exploratory development phase, will overcome this problem for most of the forward look area.

e. At very short ranges the radar presentation can become so cluttered that it is extremely difficult to interpret. Another limitation for low level operations is the low grazing angle which sharply reduces radar effectiveness at low altitudes. While current attack radars are suitable for nuclear delivery, they do not provide sufficient resolution for high accuracy conventional bomb delivery.

f. Table 3, page EC-12b, lists current and developmental airborne radar systems.

4. (S) Doppler Systems

a. A self-contained actively radiating sensor which provides a fairly accurate long term measurement of velocity and drift angle. When coupled with an accurate heading reference it can provide navigation information which is roughly proportional to the distance traveled. Systems now in development should be able to provide excellent short term velocity

information as well as absolute altitude and altitude rate data.

b. The following table lists current and developmental doppler systems and some performance characteristics. It should be noted that the difference between the doppler and system errors are due mainly to the poor heading reference and to the use of an analog computer.

<u>SYSTEM*</u>	<u>BAND</u>	<u>AIR-CRAFT</u>	<u>DOPPLER ACCURACY</u>	<u>VELOCITY ACCURACY</u>	<u>SYSTEM ACCURACY</u>
APN-131	X	F-105	0.5%	4.2fps	1.7% (Distance
APN-147	(V)X	C-141	0.5%	4.2	1.0% Travelled)
APN-153	KE	A-7	0.5	4.2	1.0%
C-5	KE	C-5	0.1	0.9	0.2%
GPL	KE	AMSA	0.05	0.4	0.1%
LFE	KE	AMSA	0.05	0.4	0.1%

5. (U) LORAN

a. A low frequency (110KHz) hyperbolic radio navigation system currently operational in South East Asia. A special receiver is required in the aircraft which discriminates between incoming signals from three ground stations and measures the reception time difference between two pairs. Position repeatability from 100 to 250 feet in the LORAN coordinate system is possible. If the target is not known in LORAN coordinates, a predictability accuracy of about 600 to 1500 feet can be obtained which is suitable for aircraft navigation. A weapon delivery capability is being investigated but will not be available in the near future. Aircraft currently equipped with LORAN receivers can navigate to at least the predicability levels in the LORAN coverage areas.

b. The following table lists current and developmental LORAN receivers:

<u>SYSTEM</u>	<u>TYPE</u>	<u>ACCURACY</u>	<u>USING AIRCRAFT</u>
APN-152	C	0.2 μ sec	Transports
ARN-78A	C	0.1 μ sec	Transports
ARN-85	C/D	0.05 μ sec	Fighters
ARN	C/D	0.05 μ sec	Fighters

* The first three systems use analog computers; the second three systems use digital.

6. (C) Ground Radar

a. Ground radar systems can provide an all-weather capability for navigation and weapon delivery within its line-of-sight and range limitations. The ground installations require an accurate survey and a common coordinate reference tying the radar to the target. Once the aircraft has been acquired by the radar its position is followed on a plotting board at the ground radar site. The aircraft is directed by data from a ground based computer which calculates heading and time to the bomb release point. Steering directions are transmitted to the pilot by voice or by data link to a steering meter or to the autopilot for automatic steering. Release can be initiated by a voice count or automatically through the data link. Only one aircraft can be directed at a time although formation drops can be accomplished. The best accuracy is obtained from beacon track with data link directing and release.

b. The following table lists current operational ground radar director systems:

<u>SYSTEM</u>	<u>TP Q-10</u>	<u>MSQ-77</u>
Range (Skin track)	25nm	50nm
Range (Bcn track)	50nm	100nm
Manual Release	A-4	All
Auto Release	F-4	In Development
Accuracy (10-20nm)	150-200' CEP	125-175' CEP
Accuracy (50nm)	300-400' CEP	300-400' CEP
Accuracy (100nm)	--	300-400' CEP
USING SERVICE	USMC	USAF

7. (C) Satellite. The Transit navigation satellite system has demonstrated excellent surveying accuracies (distance between two points both receiving Transit signals). It has also demonstrated good navigation accuracies in both ships and aircraft. Position determination from Transit requires a special radio receiver which measures the doppler shift of the satellite transmitted radio signal. With about three to six separate measurements during a pass, the position of the receiver relative to the satellite can be computed to about 0.05nm. Since the satellite also transmits its

orbital position relative to the earth, the geographic location of the receiver can also be computed to about 0.1nm.

Transit is still a developmental item. However, it offers potential as a surveying tool and as an aid for updating inertial navigation systems.

8. (C) Low Light Level Television (LLTV)

a. A self-contained electro-optical system which provides an image of a ground scene similar to that of a household TV set. Special detectors which amplify the light received allow the system to produce a visible scene under star light conditions when the human eye could see little or nothing at all. The operator can then change the azimuth and elevation of the field of view to search the area ahead of the aircraft. He also can change from a wide field of view to a narrow field of view for better resolution of small areas. Since the presentation is like a picture rather than a ground map, only the relative line-of-sight to a target can be measured: range to the target cannot. LLLTV can assist in night navigation and weapon delivery, but its effective range is limited by the amount of light available.

b. Current development LLLTV systems are listed in the following table. The range and required light are shown for targets of about vehicle size.

<u>SYSTEM</u>	<u>SERVICE</u>	<u>FOV (deg)</u>	<u>RANGE</u>	<u>REQ'D LIGHT</u>
BAT MAN	Army	12 x 16	6000'	1/4 Moon
TROPIC MOON I	USAF	(30 x 40)		
		(4.1 x 6)	6000'	1/4 Moon
TROPIC MOON II	USAF	(10.5 x 14)		
		(4.8 x 6.4)	6000'	Starlight
BLACK SPOT	USAF	(12 x 16)		
		(4.8 x 6.4)	6000'	Starlight

9. (S) Forward Looking Infrared (FLIR)

a. A self-contained electro-optical system which provides an image of a ground scene somewhat like a TV system, but sufficiently different that some scope interpretation is needed. Special detectors, which are sensitive to specific bands of infrared radiation, sense the temperature differences on the ground, a corresponding line is portrayed on a cathode ray tube. Increased temperature difference produces a large received signal which results in a brighter spot on the scope. The operator has his choice of polarity: the hotter spots may be portrayed as light areas (as described above) or they may be portrayed as dark areas against a light background. Having both options will allow the operator more flexibility in interpreting the scene. The operator also has the option in some systems to change the elevation and azimuth of the field of view for better resolution of small areas.

b. Since the presentation is like a picture rather than a ground map, only the relative line-of-sight to a target can be measured; range, cannot. FLIR can assist in night navigation and weapon delivery providing suitable temperature differences exist between indentifiable ground features. Current FLIR techniques have only a limited range capability and are highly degraded by humid conditions. Consequently, any weapon delivery tactics using FLIR in Southeast Asia will require operations at low altitudes and slow speed (i.e., below 4500 feet and slower than 140 kts).

c. Current developmental FLIR systems are listed in the following table. All have a scan rate of 30 frames per second.

<u>SYSTEM</u>	<u>SERVICE</u>	<u>RESOLUTION</u>	<u>T SENSIT</u>	<u>F.O.V.</u>
RED SEA	USAF	2mR	0.8°C	20° x 40°
LONESOME TIGER	USAF	1mR	0.5°C	20° x 40°
BLACKSPOT	USAF	1 x 1.3	0.5°C	12° x 40°

10. (C) LASER Ranging

a. A self-contained electro-optical system which provides precise range to the target. A LASER transmits coherent light which reflects from the target and is sensed by an electro-optical detector. Since the light is coherent it can be focused into a very small beam (about 0.5 to 2.0 milliradians).

b. The following table lists current and developmental LASER ranging systems:

<u>SYSTEM</u>	<u>AIRCRAFT</u>	<u>PERFORMANCE</u>
Aides Visual Weapon Delivery	F-4C/D	± 15 ft. Approx.
Simplified Aided Visual	F-100	± 15 ft. Approx.
TROPIC MOON II	B-57	± 15 ft. Approx.
BLACK SPOT	C-123	± 10 ft. Approx.

11. (U) OPTICS

a. Optical systems will not be covered in detail but telescopes and sights are still the most accurate method of providing precise line-of-sight to a target when adequately stabilized. They are mentioned here solely as a reminder that optical systems should be tied into any weapon delivery system for use when conditions allow.

12. (S) Side Looking Airborne Radar (SLAR)

a. A self-contained ground mapping sensor which provides a strip map to one side of the aircraft and primarily applicable to reconnaissance operations. With real time read-out it can also be used for dead reckoning navigation. A weapon delivery capability using SLAR is under development but would not be available in the time frame of this study.

b. There are two types of SLAR techniques in use. The first uses a physical-long antenna array to achieve the narrow beam width needed for high resolution. The second type, called a synthetic aperture radar, uses the motion of the aircraft to synthesize an antenna which is electronically long although the

synthetic aperture system offers the most potential. The incoming signals can be processed for doppler shift and the SLAR used to detect objects which are moving on the surface such as trucks and trains. The limiting velocity is about 5 to 15 mph so very slow traffic cannot be detected in this manner nor can a moving radar antenna.

c. Table 1 on page EC-12a, lists current and developmental SLAR systems.

13. (S) Downward Looking Infrared (DLIR)

a. A self-contained electro-optical system which provides an IR ground scene along the flight path of the aircraft. Special scanning detectors, which are sensitive to specific bands of infrared radiation, sense the temperature differences on the ground during each scan. By synchronizing this lateral scan with the forward motion of the aircraft, a swath along the aircraft's track can be mapped. Current DLIR systems do not have a real time read out so they are primarily applicable to reconnaissance operations. Development efforts are underway to provide real-time-read-out. Such a system could possibly be used for navigation in addition to recon. Using DLIR for weapon delivery would require weapons which could be fired to the rear since one cannot see the target until the aircraft has actually passed it.

b. Table 2 on page EC-12a, lists current airborne IR sensor devices.

14. (U) Air Data Systems

There are a variety of self-contained air data sensors which provide aircraft data relative to the atmosphere which are needed for flight control and weapon delivery. Some of this data can also be used for gross DR navigation. The primary air data system outputs are relative speed, pressure altitude, altitude rate, mach number angle of attack, and temperature. Since these sensors are in general use further discussion will not be given. They are mentioned only to add completeness to the required sensors picture.

15. (U) Aircraft Communication, Navigation, and Identification Systems

Table 6, page EC-12e, lists all aircraft types currently employed (and planned) for Southeast Asia. It also shows the nomenclature of communication, navigation, and identification equipments installed.

TABLE 1

SIDE LOOKING AIRBORNE RADAR (SLAR)

<u>SYSTEM APPLICATION</u>	<u>FREQUENCY PEAK POWER</u>	<u>ANTENNA BEAM WIDTH</u>	<u>RESOLUTION</u>	<u>MAX RANGE ALTITUDE</u>	<u>WEIGHT</u>	<u>SPECIAL FEATURES</u>
APS-9A, 9A-AO-1BF	9245 MHz 65 Kw	Fixed Pod 0.5° (Az)	250' (Rng) 0.5° (Az)	90 Km 10000'	750 lb	Non-coherent AMTI Film w/infltr viewer
APQ-102A RF-4B/C	9.6 GHz 50 Kw	Stabilized 1.50° (Az)	50' (Rng) 50' (Az)	30 NM 40000'	435 lb	Focused coherent passive CHIRP Film/ and Processor
APD-7 RA-5C	34.85 GHz 100 Kw	Fixed 0.15° (Az)	60' (Rng) 45' Az 250' (Rng) 740' Az	@ 3 NM @ 40 NM	475 lb	Non-coherent CRT and Film
APQ-97 Development	34.85 GHz 100 Kw	Stabilized 0.11° (Az)	30' (Rng) 50' (Az)	10 NM 40000'	913 lb	Non-coherent CRT and Film display
APQ-108 Development	9375 MHz 2 Mw	Stabilized 10° (Az)	10-15' (Rng) 10-15' (Az)	80-100 NM 40000'	10,000 lb	Focused coherent Active CHIRP Film/ and Processor
APS-73 Experimental	9.4 GHz 50 Kw	Stabilized 0.6° (Az)	50' (Rng) 50' (Az)	50 NM 40000'	1900 lb	Focused coherent CHIRP CRT and Film, A/B Process
UPD-3 Development	9-10 GHz 500 Kw	Stabilized 2°	3 meter (Rng) 2 meter (Az)	150 KM 36600'	800 lb	Focused coherent Laser PPSCTIR, Film/Gnd
DPD-3 Development	9375 MHz 7 Kw	Fixed 1.8° (Az)	250' (Rng) 1.8° (Az)	10 NM	160 lb	Unfocused coherent Film/Gnd Processor

TABLE 2
INFRA RED SENSOR DEVICES

<u>SYSTEM</u>	<u>TYPE AND PURPOSE</u>	<u>SPECTRAL RESPONSE</u>	<u>RESOLUTION</u>	<u>SCAN ANGLE</u>	<u>CRT</u>	<u>FILM</u>
AAD-2	Low altitude IR mapper	1-7 μ	3 m	120°	X	X
AAS-18	Low altitude high speed IR mapper	8-14 μ	1-3 m	120°		X
UAB-4	Low altitude, low speed IR mapper	0.7-14 μ	3 m	80°	X	X
RS-7	Low altitude, 1h mapper	8-14 μ	1.0 m	150°	X	X
RS-10	Low altitude IR mapper	8-14 μ	0.5 m	140°	X	X
RECONOFAX	Low altitude, IR mapper	8-14 μ	3 m	140°	X	X

SECRET

TABLE 3

CURRENT AND DEVELOPMENTAL RADAR SYSTEMS

SYSTEM APPLICATION	FREQUENCY PEAK POWER	ANTENNA TYPE OF BEAM	BM WIDTH PLS WIDTH	CONTRACTOR WEIGHT	AIR-TO-AIR			AIR-TO-GROUND				SPECIAL FEATURES		
					SEARCH/ACQ	RANGING	TRACKING	NSL GUID	MAPPING	RANGING	PGT TRNG		TER AVOID	TER FOLLO
APQ-77 F-4B	X-band 250 kw	32" Dish Pencil, conic.	3.2° 0.4-2.0 μs	WESTING.	X	X	X	X						
APQ-83 F-8D	X-band 100 kw	13" Dish Pencil	8° 0.7 μs	MAGNAVOX 245 lb	X	X	X							
APQ-97 A-6A	Ku-band 170 kw	39" Dish Cac²	1.4° 0.4-3.0 μs	NORDEN 350 lb	X	X	X	X		X	X	X	X	Self test
APQ-94 F-8E	X-band 160 kw	20" Dish Pencil, conic.	4.5° 0.7 μs		X	X	X	X	X					
APQ-99 RF-4B/C	Ku-band 60 kw	21"x12" Dish Pencil, Cac²	2.5° 0.2-1.0 μs	TEX INSTR 210 lb				X		X	X	X		
APQ-100 F-4C	X-band 250 kw	32" Dish Pencil, conic.	3.2° 2.0 μs	WESTING.	X	X	X	X	X					
APQ-101 YRF-4C Test	Ku-band 60 kw	21"x12" Dish Pencil, Cac²	2.5° 0.2 μs	TEX INSTR 125 lb				X		X	X	X		Modif APQ-99
APQ-109 F-4D	X-band 250 kw	32" Dish Pencil, conic.	3.2° 0.4-2.0 μs	WESTING. 490 lb	X	X	X	X	X					Modif APQ-72
APQ-110 F-111A/Mk 1	Ku-band 30 kw	8" Parabolic Pencil	0.2 μs	TEX INSTR 218 lb				X	X		X	X		
APQ-112 A-6A	Ku-band 60 kw	14" Parabolic Pencil	0.4 μs	NORDEN 200 lb	X	X	X	X	X	X			X	Monopulse Doppl Self test
APQ-113 F-111A/Mk 1	Ku-band 65 kw	36" Parabolic Pencil, Cac²	1.6° 0.4-2.4 μs	GE-LMED 360 lb	X	X	X	X	X			X		Freq/Pol Agilit Self test
APQ-115 Sky Hook	Ku-band 60 kw	21"x12" Dish Pencil, Cac²	2.5° 0.2-1.0 μs	TEX INSTR 200 lb				X		X	X	X	X	Modif APQ-99
APQ-116 A-7A	Ku-band 60 kw	21"x12" Dish Pencil, Cac²	2.5° 0.2-1.0 μs	TEX INSTR 325 lb	X	X		X	X		X	X	X	Modif APQ-99
APQ-119 F-111A (Proposal)	Ku-band 145 kw	36" Parabolic Pencil, Cac²	1.6° 0.7-2.0 μs	GE-LMED 370 lb	X	X	X	X	X			X		APQ-111 w/AMTI Self test, Freq & polar agility
APQ-120 F-4B/E	Ku-band 120 kw	29" Dish Pencil, conic.	3.5° 0.2-2.0 μs	WESTING. 400 lb	X	X	X	X	X					X Miniturized APQ-109 w/CURDS
R-14 F-105	X-band 100 kw	32" Dish Pencil, Cac²	3.3° 1.0 μs	AUTONETICS 280 lb	X	X	X		X	X		X		Monopulse
R-101 F-111A/Mk 2	Ku-band 100 kw	Pencil, Cac²	1.5° 0.1-2.2 μs	AUTONETICS 440 lb	X	X	X	X	X	X				X Freq/Pol agil. IFF, Self test
R-132A Black Spot	X-band 80 kw	21"x36" Dish Cac²	2.5° 0.1-1.0 μs	AUTONETICS				X	X		X			X Freq agility
AWG-9 F-111B/PHX	X-band 9 kw	36" Planar Arr	2.2° 1.33 μs	HUGHES 1400 lb	X	X	X	X	X			X		Pulse doppler Self test
AWG-10 F-4J	X-band 2 kw	32" Dish	2.6° 0.2-1.5 μs	WESTING. 800 lb	X	X	X	X	X		X	X		Pulse doppler

SECRET

EC-12b

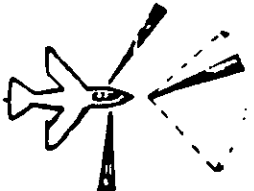

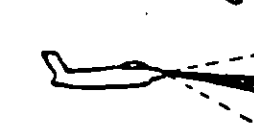







Table 3 to
Annex C to
Appendix E

NAVIGATION/SENSOR SUMMARY

SENSOR	FUNCTION & TYPE	MEASUREMENTS	APPLICATIONS	LIMITATIONS
INERTIAL SYSTEM	Self-contained Navigation <u>Passive System</u>	Measures acceleration. Computes velocity and position.	Provides short term velocity, direction & vertical reference for flight control, weapon delivery and navigation systems.	Exhibits errors which build up with time and which oscillate about a mean value.
FLAR (Forward Looking Airborne Radar)	Self-contained Navigation and weapon delivery <u>Active System</u>	Provides radar map and line of sight and range to a target.	Provides relative position of aircraft to a target	Limited by resolution, grazing angle, and line of sight constraints. Requires scope interpretation
DOPPLER SYSTEM	Self-contained Navigation. <u>Active System</u>	Measures velocity Computes position	Provides long term velocity reference for navigation.	Requires a precise heading reference for accurate navigation.
LORAN	Ground Reference Navigation system (weapon delivery?) <u>Active System</u>	Measures position in LORAN (time diff) coordinate system.	Provides excellent position repeatability if the target is known in LORAN coordinates.	Requires ground to station. LORAN coverage not worldwide. Weapon delivery capability not available yet.
GROUND RADAR	Ground Reference Navigation & weapon delivery system (Beacon track) <u>Semi-Active (Skin track)</u>	Provides position of aircraft with respect to radar site, which can then compute velocity, altitude, and weapon delivery information.	Provides excellent position information if aircraft is within radar line-of-sight and range. Same carrier can be used as a data link.	Limited by radar coverage and line-of-sight constraints. For accurate bombing, target location must be known accurately in radar coordinate frame.
SATELLITE	External reference Navigation system <u>Semi-Active</u>	Measures position with respect to Satellite.	Position of aircraft can be computed. Excellent for surveying applications and has a potential for up-dating inertial systems.	Coverage is not continuous. Requires a special radio receiver and precision frequency standard.
LLTV (Low Light Level Television)	Self-contained ground scene for navigation and weapon delivery. <u>Passive</u>	Provides ground scene and relative line of sight to target. Related to scene illumination and sensor response parameters.	Night navigation and weapon delivery	Picture presentation rather than ground map. Cannot measure range. Requires some light and contrast in target. Limited in range.
FLIR (Forward Looking Infrared)	Self-contained ground scene for navigation and weapon delivery. <u>Passive</u>	Provides ground scene and relative line of sight to target. Relative contrast is related to temperature difference.	Night navigation and weapon delivery.	Picture presentation that requires scope interpretation. Cannot measure range. Requires temperature difference of target and background. Limited in range especially so under high humidity conditions.
LASER RANGING	Self-contained weapon delivery sensor <u>Active</u>	Provides precise range to target.	Weapon delivery	Target must be identified and LASER beam continuously directed on target by some means
OPTICS	Self-contained weapon delivery sensor <u>Passive</u>	Provides precise relative line-of-sight to target.	Can magnify or isolate the scene after target has been located.	Primarily a daylight device.
SLAR (Side Looking Airborne Radar)	Self-contained recon sensor <u>Active</u>	Provides a radar strip map to one side of the aircraft.	All weather recon. Can also provide DR navigation capability if real time readout is available.	Primarily a recon device. The limited weapon delivery potential of SLAR has not yet been fully developed. Radar line-of-sight constraints.
DLIR (Down Looking Infra Red)	Self-contained recon sensor <u>Passive</u>	Provides a strip map of IR contrasts along flight path.	Night recon. Can also provide DR navigation capability if real time readout is available.	Primary a recon device. Weapon delivery would require a rearward firing munition and real time readout.
AIR DATA	Self-contained navigation, flight control, and weapon delivery sensor	Provides relative speed altitude and attitude of aircraft with respect to an atmospheric datum.	Provides information with respect to atmospheric datum for flight control and weapon delivery.	Cannot be accurately related to an earth fixed coordinate system.

TABLE 5

RADAR REQUIREMENTS FOR MULTIMISSIION TACTICAL AIRCRAFT

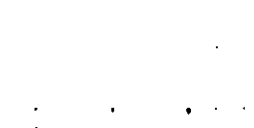
RADAR MODE OR FUNCTION	SYSTEM ENVIRONMENT			ANTENNA BEAM CONFIGURATION	SYSTEM REQUIREMENTS	MISSION OR MISSION PHASE								
	Air-to-Air	Air-to-Ground	Multifunction			Navigation	Logistics	Penetration	Close Support	Interdiction	Intercept	Reconnaissance	Recon-Strike	Blind Approach
Mapping-Forward	X	X			Beam spilling required for constant ground illumination. Has been combined with air-to-air search systems.	X	X	X	X	X	X	X	X	
Mapping-squint	X	X			Spilled beams; motion compensation critical, separate systems, but squint may be possible with non-angle-limited agile beam systems.								X	
Mapping - sidelooking	X				Asimuth monopulse for high accuracy (1/2 deg); horizontal polarization; must reject sidelobes. Manual flight control via displays.		X	X	X				X	X
Terrain Avoidance (TA)	X	X			Elevation monopulse for high accuracy (1/2 deg); vertical polarization; sidelobe rejection; update data 1 cps.		X	X	X				X	X
Terrain Following (TF)	X	X			Monopulse pencil beam; sidelobe cutter rejection; narrow beam required to reduce truncation/grazing-angle error.					X	X		X	
Air-to-ground Ranging (AGR)	X	X			Redundant with barometric altimeter and air-to-ground ranging system; separate system.		X	X	X			X	X	X
Radar Altimeter	X				Doppler filtering and algebraic computation; 2 beams minimum for ground speed and drift antis; 3 beams (Janus) minimum for along-heading, cross-heading and vertical velocities; separate system.	X	X	X	X	X	X	X	X	X
Doppler Navigator	X	L			Narrow beam; circular polarization may be an aid; clear air turbulence (CAT) avoidance still in research	X	X					X	X	X
Weather Avoidance	X	X			Good antenna pattern, high power and Doppler processing to reject ground clutter; variable scan rate and beam pattern helpful.					X		X	X	X
Search/Acquisition	X	L	X		4 lobe monopulse pencil beam or conical scan; also track while scan via computers could increase datarate.						X	X	X	
Target track	X	L	X		Pencil beam with special code transmitter and receiver; problems exist in frequency allocations. Also required in landing clearance.	X	X		X	X			X	
Beacon Interrogation, IFF	X	X	X		Continuous-wave pencil beam to illuminate target for semi-active homing.					X		X		
Missile Guidance	X	X										X		

L means Limited capability

~~SECRET~~

TABLE 6

AIRCRAFT IN SEA	AIRCRAFT COMMUNICATIONS/NAVIGATION/IFF EQUIPMENT							NAVIGATION			IFF		INTER-ROBOTS	
	COMMUNICATIONS							ASB	ORNI	TACAN	LORAN	TRANS-POUNDER		STP
	UHF AM 1750 CHAS	UHF AM 3500 CHAS	UHF DATA	VHF	HF VOICE	HF DATA/TTY	HF DATA/TTY							
A-1 H/I	ANC77A						ASB 6		ANR21			APX 6	APAD9	
A-1 H/C/E	ANR17B								ANR21			APX 6	APAD9	
A-6 A	ANR57		2/ANR75						ANR21			APX 6	APAD9	APX
F-4 B	ANR19								ANR21			APX 6	APAD9	APX
F-8 B	ANR17B								ANR21			APX 6	APAD9	
EA-3 B	ANC77A			ANC101	ANC119		ASB 6	ANR19	ANR21			APX 6A	APAD9	
EF-4 B		ANR28		ANC105					ANR21			APX 6A	APAD9	
EF-4 A/B	ANR17 ANR17B								ANR21			APX 6A	APAD9	
EA-3 C	ANR56 ANR56A								ANR21			APX 6A	APAD9	
E-1 B g/	ANR54B			ANC101	ANR58A				ANR21A			APX 6B	APAD9	APX
E-2 A g/	ANR58A		ANR14		ANR58	ANR28	ASB 13		ANR21A			APX 6B	APAD9	APX
EA-1 F g/	ANR74A						ASB 6		ANR21			APX 6B	APAD9	
EA-3 B	ANC77A				ANC119		ASB 6	ANR106	ANR21			APX 6A	APAD9	
EA-6 A	ANR57		2/ANR75						ANR21			APX 6A	APAD9	
EC-121 B g/	ANR71A			ANC101	ANR119 TTY		ASB 6(1)	ANR106	ANR21		APX 70	APX 6	APAD9	APX
EF-10 B	ANR77B						ASB 6		ANR21			APX 6	APAD9	
EA-3 B	ANC77A				ANR119		ASB 6	ANR106	ANR21			APX 6A	APAD9	
F-4 C	ANR19								ANR21			APX 6A	APAD9	
F-105 B/V	ANR17		2/ANR56						ANR21			APX 6A	APAD9	
EF-4 C		ANR28		ANR105					ANR21			APX 6A	APAD9	
EF-102	ANR54		ANR28				ASB 90	ANR106	ANR21			APX 6B APX 75	YES	
EA-66 B/C	ANR7 ANR70							ANR14	ANR21 ANR29			APX 6A APX 6B	YES	
EC-57	ANR57			ANR24 VHF-FM ANR5 ANR24 ANR29 ANR101	ANR29 610P TTY		ANR67	ANR14 ANR18 ANR14	ANR21 ANR21	APX 9	APX 70	APX 75 APX 75	YES YES	APX
EC-121 B	ANR54B						ASB 6	ANR14 ANR14	ANR21 ANR21	APX 70	APX 70	APX 75 APX 75	YES YES	APX
EC-135	ANR54B				ANR58B			ANR14	ANR21 ANR77	APX 70	APX 70	APX 75 APX 75	YES YES	
C-130 A/B	ANR54			ANR101	610P		ASB 6	ANR14	ANR21	APX 70	APX 70	APX 75 APX 75	YES YES	
EC-130 A/B	ANR54B			ANR101	610P		ASB 6	ANR14	ANR21 ANR21	APX 70	APX 70	APX 75 APX 75	YES YES	
EC-135A	ANR54B			ANR101	ANR100			ANR14	ANR21 ANR77 ANR21	APX 70	APX 70	APX 75 APX 75	YES YES	
P-51	ANR21B			VHF-FM	ANR21A			ANR14	ANR21	APX 9	APX 9	APX 75	YES	
AIRCRAFT TO BE DEPLOYED FY 66														
A-7 A		ANR51A	ANR5									APX 6A	YES	
F-4 J		ANR19A										APX 6A	YES	
F-4 B		ANR19A			ANC101							APX 6A	YES	
AIRCRAFT TO BE DEPLOYED FORT FY 66														
F-111 B		ANR51A	ANR28	ANC104	ANC123				ANR54			APX 66 APX 6A	YES	
E-2 B g/	ANR28		ANR28		ANR119	ANR28			ANR54			APX 66 APX 6A	YES	APX
EA-6 B	ANR57		2/ANR75		ANC123				ANR54			APX 66 APX 6A	YES	
A-7 B	ANC109			ANR28					ANR74			APX 72	YES	
F-4 B	ANR19								ANR74			APX 72	YES	
F-111 A	ANC109		2/ANR75		ANC112				ANR74			APX 72	YES	

2/ Not UHF equipped aircraft have UHF/ASB feature
 2/ ASB means integrated communications - navigation - IFF package
 2/ Incorporated in ASB - (X)
 2/ Aircraft has 2 on ASB 97's for UHF relay
 2/ UHF relay aircraft

~~SECRET~~

EC-12e

Table 6 to
Annex C to
Appendix E

ANNEX D TO APPENDIX E
ELECTRONIC WARFARE

1. (S) Passive Electronic Warfare

a. Collection of tactical ELINT of the NVN defense environment is accomplished on a very limited basis. Surveillance and location of ground radars, especially SAM and AAA, can be accomplished only at specific times during a mission. Collection platforms are configured with manually operated systems which are time consuming, especially when operators are attempting to identify and correlate bearings of similar signals which are of short duration. In addition the collection platforms with dual capability (ELINT/ECM) are at present technically restricted to operating only one system at a time. Consequently, during periods when ECM suppression is required in support of strike missions the time necessary to obtain a consecutive family of bearings is not available.

b. COMMANDO LANCE, BIG LOOK, BIG EYE, EB-66C, and the EA-3B aircraft are utilized to provide MIG and/or SAM warning in support of strike operations in North Vietnam. However, due to the lack of new platforms and the antiquated equipment configured in our present aircraft, the full potential of Electronic Warfare (EW) is not realized. Although each of these aircraft, with the exception of BIG EYE, have an ELINT collection capability, the redundant and time-consuming assignment of providing SAM/MIG warning precludes their collection of complete tactical ELINT data within the target area. BIG LOOK aircraft is capable of recording the ground defense environment within a 150 mile radius of a package area in which it is orbiting. Other EW support aircraft are only able to intercept, detect, and record the NVN ground radar environment during ingress and egress from target area. The processing, correlation, and analysis of the recorded data is accomplished after return to the home station. The RA-5C could provide voluminous data on emitters in the area and provide photo intelligence but requires time-consuming Integrated Operational Intelligence

Center computer readout. In the case of the EA-3B its recorded ELINT data is reduced after return to Japan or the Philippines. Although a limited amount of RB-47s are available in the area for data collection, their data must also be processed in Japan. As the above paragraph implies the time delay between data collection and processing is excessive.

c. Tactical ELINT collection of the NVN defense environment is neither timely, nor accurate, nor sampled across the electromagnetic spectrum. This precludes perishable ELINT/COMINT data from being available to tactical commanders for daily operational planning and formulation of a meaningful Electronic Order of Battle.

2. (S) Active Electronic Warfare

a. Currently the number of jammers available within Southeast Asia is insufficient to provide self-protection to all tactical strike and attack aircraft. The present systems, regardless of techniques, are designed primarily against S-band, AAA and SAM threats. The follow-on systems (QRC-160-8 and ALQ-100) are designed to counter both S and C-band threats. Priority programs must be expedited to erase shortage of EW systems required to provide self-protection today.

b. The effectiveness of the ALQ-51 and QRC-160-1 is validated by the recent Weapon System Evaluation Group and CINCPACFLT studies. These studies attest to the actual increase in altitude (10-17,000 feet) flown by strike forces to the target as well as the absence of precision AAA firing and increased miss distance of SAM missiles.

c. When strike aircraft, configured with jammers, are required to accomplish extreme maneuvering (i.e., 90 degree bank) there is a degradation of jamming effectiveness. Whether there exists a dead zone during maneuvering or to what degree is unknown at this time.

d. One of the most significant countermeasures which could have a dynamic effect upon survivability is the development of a high powered SAM fuze jammer.

3. (S) Radar Homing and Warning Systems

Current Air Force inventory of Radar Homing and Warning (RHAW) systems in Southeast Asia are adequate and effective. The aircrews have expressed a sincere sense of confidence in this system. The Navy follow-on system (APR-30 RHAW) is currently in production and will correct the quantitative and qualitative deficiencies of the APR-23. The major deficiencies in our RHAW systems is the inability to accurately obtain range to target which would enhance the effectiveness of air-to-surface missile launches.

4. (S) Communications

Communications between electronic collection platforms are limited to SAM and MIG warning over UHF guard channels. However, provisions have been made to provide Kw-7 communications between BIG LOOK aircraft and ground stations located at Danang, the PIRAZ ships, and CTF-77. There is no secure voice communications between collection platforms and strike aircraft, however the KY-28 could be used for this purpose.

~~SECRET~~

TAB A TO ANNEX D TO APPENDIX E

~~SECRET~~

ELECTRONIC WA

117F

LAW DEPARTMENT	TELETYPE TO 007	74	75	100	124	200
	WORLD WAR II CODE					
	LETTER CODE					

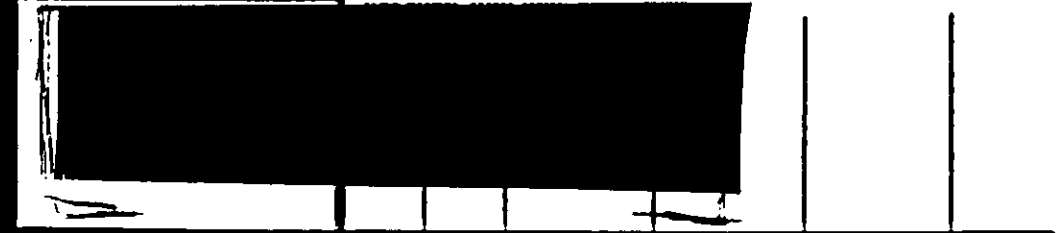

U. S. COUNTER - MEASURES	ARMED	GRC-306 GRC-326 ALT-25 GRC-05 ALT-09 ALT-05	GRC-378 ALB-42 ALT-22 ALB-33	GRC-300-4 GRC-300-6 ALB-05	GRC-3044 GRC-377 GRC-371 GRC-328 ALT-07	GRC-3046 ALB-09 ALB-26 GRC-307 ALB-42	
	DRAFT	[Redacted]					
	RESEARCH	ALB-38 APB-0 APB-44 GRC-305 GRC-307 ALB-21	ALB-39 GRC-303	PIVILLE AND ALB-32 APB-38 ALB-37	ONE LOON APB-30V ALB-23 [Redacted] [Redacted]	LAMB-0 CODE-SECRETOR SIMULATOR BENTY SECRETY LAMB-26	
	UPGRADES	ALB-21 ALB-23 LAG-47 LR. WARNING RECEIVER GRC-320	[Redacted]	ALB-09 APB-30V ALB-28 ALB-35	APB-32 TLANER I & O GRC-308 GRC-322		

~~SECRET~~

~~SECRET~~

TAB A TO ANNEX D TO APPENDIX E

RFARE

7500 7600 7700 7800 7900 8000 8100 8200 8300 8400

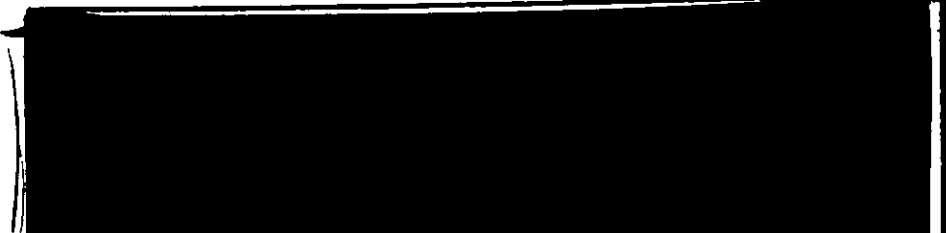

AF

GRC-300A-4 ALD-61 ALT-68 GRC-66	ALD-71 GRC-370 ALT-43 ALD-600	GRC-300-5 GRC-321 GRC-325 ALD-70 GRC-301 GRC-344	ALD-69 ALT-37 GRC-372	GRC-370 ALD-68		ALD-77 ALT-65	ALD-41 GRC-300	GRC-377 ALD-71 GRC-370 ALD-61 ALT-37 TR-43 ALD-600
GRC-442 ALD-3 ALT-34	ALI-10 ALT-34	ALI-25	2200-0A ALI-20		2200-0A ALI-20	GRC-442 ALI-2	ALI-10 ALI-34	ALI-20
ALD-20 ALD-23 APS-0 ALD-30 2200-0A ALD-51	APS-20 ALD-20 C10 LOCK GRC-320 ALD-51	EX-123 2200-7A APS-20V APS-22 APS-24	2200-0 APS-20 GRC-370		GRC-317 APS-4070	ALD-01 ALD-73 APS-0 ALD-05 ALD-20	APS-20 ALD-20 APS-70 APS-20V APS-23	2200-7A 2200-0 APS-24
	ALD-04 GRC-334 APS-1070 APS-30	GRC-372 APS-4070 CELS	GRC-317 GRC-300			ALD-20 APS-0 GRC-300 APS-30	APS-1070 GRC-372 APS-1070	

Current E.W. Equipment
 E.W. Equipment by 1968
 E.W. Equipment after 1968

SECRET

~~SECRET~~

SECRET

ELECTRONIC WARFARE EQUIPMENT DELIVERY
SCHEDULE FOR SOUTHEAST ASIA a/

QRC- 160A-1

QRC- 160 -8

QRC- 321

QRC- 335

ALQ- 51

ALQ- 71

ALQ- 81

ALQ- 100

a/ See Table 1

SECRET

ED-4

Annex D to
Appendix E

~~SECRET~~

TABLE 1

ECH EQUIPMENT SCHEDULED FOR SEA

	1967												1968		
	D	J	F	M	A	M	J	J	A	S	O	N	D	J	F
Navy Equipment															
ALQ-100	-	-	-	-	-	-	63	65	80	80	90	99	-	-	-
ALQ-51	25	-	-	97	-	516	-	-	-	-	-	-	-	-	-
ALQ-81	8	-	-	7	12	6	6	33	-	-	-	-	-	-	-
Cumulative Navy Total	33	-	-	137	149	671	740	838	919	998	1088	1187	-	-	-
USAF EQUIPMENT															
QRC 160A-1	76	-	-	-	25	28	-	-	-	-	-	-	-	-	-
ALQ-71	5	15	30	40	42	42	29	21	21	21	21	-	-	-	-
a/ ALQ-51	-	5	-	-	-	-	-	-	-	62	-	-	-	-	-
QRC 160-B	-	-	-	-	-	2	7	15	15	15	20	25	30	30	30
b/ QRC-321	-	-	-	-	-	-	-	-	-	-	14	-	-	-	-
QRC-335	-	-	-	-	-	-	-	-	-	20	20	20	20	20	20
c/ Cumulative USAF Total	81	101	126	166	233	305	341	377	413	531	544	589	639	689	719

a/ Internal Installation

b/ 2 Half Cylinders for Mounting on Side of Fuselage (Wild Weasel F-105F)

c/ Losses Not Included

~~SECRET~~

ED-4a

Table 1 to
Annex D to
Appendix E

~~SECRET~~

ELECTRONIC WARFARE EQUIPMENT PRESENTLY
IN SOUTHEAST ASIA

RECEIVERS^{a/}

APR-9
ALA-12
APR-14
ALR-18
ALR-20
ALQ-28
ALQ-39
ALQ-53
ALQ-61
QRC-315
BIG LOOK
BRIGAND
GAINTIME
PHYLLIS ANN

RADAR HOMING & WARNING^{b/}

APR-23
APR-24
APR-25
APR-26
APR-28V
APR-29
ER-133
ER-142

JAMMERS^{c/}

ALT-6B
ALT-13
ALT-15
ALT-16
ALT-22
ALQ-33
ALQ-41
ALQ-51
ALQ-51 (Mod II)
ALQ-55
QRC-65
ALQ-71
QRC-160-1
QRC-160A-1
QRC-160-2
QRC-160-4
QRC-160-5
QRC-279

EXPENDABLES^{d/}

ALE-2
ALE-18
ALE-24
QRC-142

IFF SYSTEMS^{e/}

QRC-248
APX-76

- a/ See Tables 2 through 15
b/ See Tables 16 through 23
c/ See Tables 24 through 41
d/ See Tables 42 through 45
e/ See Tables 45A and 45B

~~SECRET~~

~~SECRET~~

TABLE 2

TITLE: APR-9 L, S, and X-Band Receiver

DESCRIPTION: Radar receiver capable of detecting signals from 1,000 - 10,750 MHZ (reference PRONG TONG Study, Vol II)..

AVAILABILITY: Installed, being replaced by ALR-20

QUANTITY: One per aircraft

ASSOCIATED PLATFORM: B-52D, EB-66C, BIG LOOK

~~SECRET~~

ED-5a

Table 2 to
Annex D to
Appendix E

~~SECRET~~

TABLE 3

TITLE: AN/ALA-12 Airborne Receiver

DESCRIPTION: The AN/ALA-12 is a passive direction finder system operating in the frequency range of 550 MHz to 10.75 MHz. It monitors the UHF, VHF communications and L through Z-band radars. Signal analysis/identification and estimate of PRF may be made visually. Bearing measurement may be made with an accuracy of $\pm 5^\circ$ referenced to true azimuth or aircraft bearing. The AN/APR-9 or AN/APR-13 intercept receivers are used with the AN/ALA-12 systems.

AVAILABILITY: Now

QUANTITY: 50 originally ordered, presently the last 10 are being reconditioned for the EC-121M.

ASSOCIATED PLATFORM: EC-121M

~~SECRET~~

ED-5b

Table 3 to
Annex D to
Appendix E

~~SECRET~~

TABLE 4

TITLE: APR-14 L-Band Receiver

DESCRIPTION: Radar receiver capable of detecting signals from 30 - 1000 MHZ (reference PRONG TONG Study, Vol II).

AVAILABILITY: Installed

QUANTITY:

ASSOCIATED PLATFORM: B-52D, EB-66C

~~SECRET~~

ED-5c

Table 4 to
Annex D to
Appendix E

~~SECRET~~

TABLE 5

TITLE: ALR-18

DESCRIPTION: Radar receiver capable of detecting tracking signals in the frequency range of 8,500 - 10,500 MHZ. When matched to the ALT-6B, the system provides automatic spot noise jamming of fighter tracking radars.

AVAILABILITY: Installed

QUANTITY: Two on each B-52
One on each B-66

ASSOCIATED PLATFORM: EB-66C, B-52D, EB-66B

~~SECRET~~

ED-5d

Table 5 to
Annex D to
Appendix E

~~SECRET~~

TABLE 6

TITLE: ALR-20

DESCRIPTION: A panoramic receiver with a frequency range of 50 - 11,000 MHZ. The receiver displays simultaneous presentation of the complete frequency coverage for immediate placing of jammers upon the threats. The simultaneous display permits immediate response to frequency changes by ground radars.

AVAILABILITY: December 1966

QUANTITY: One for each B-52
One for each B-66B/C

ASSOCIATED PLATFORM: B-52D, B-52H, EB-66B/C

~~SECRET~~

ED-5e

Table 6 to
Annex D to
Appendix E

~~SECRET~~

TABLE 7

TITLE: AN/ALQ-28 Airborne Intercept Receiver

DESCRIPTION: The ALQ-28 is a passive electronic surveillance receiver useable over the 50 to 10,750 MHz range. The set is a rapid scan double conversion receiver which receives AM, FM, CW, and pulse signals. Displays permit manual analysis to determine frequency, amplitude, modulation, scan rate, PW, PRF, and relative or true bearing. Storage of six signals is provided which may be recalled by the operator. It has a total of nine bands, of which any four may be operated at one time.

AVAILABILITY: Three Southeast Asia

QUANTITY: Nine

ASSOCIATED PLATFORM: EC-121M

~~SECRET~~

ED-5f

Table 7 to
Annex D to
Appendix E

~~SECRET~~

TABLE 8

TITLE: AN/ALQ-39

DESCRIPTION: The AN/ALQ-39 is a rotating loop direction finder with integral receiver and additional frequency scanning receivers covering 1 to 200 MZ in two bands.

AVAILABILITY: Three Southeast Asia

QUANTITY: Nine

ASSOCIATED PLATFORM: EC-121M

~~SECRET~~

ED-5g

Table 8 to
Annex D to
Appendix E

~~SECRET~~

TABLE 9

TITLE: AN/ALQ-53 Airborne Intercept System

DESCRIPTION: The AN/ALQ-53 is a passive receiver system which detects and analyzes signals from 40 to 26,500 MHZ in 10 frequency bands any five of which are useable at any one time. Signal frequency, modulation, PW, PRF, and signal bearing can be measured and recorded. Antenna coverage is 360° in azimuth and 0 to 45° below the aircraft roll axis. DF accuracy is less than 5° error.

AVAILABILITY: Available now

QUANTITY: 12 sets

ASSOCIATED PLATFORM: EA-6A

~~SECRET~~

ED-5h

Table 9 to
Annex D to
Appendix E

~~SECRET~~

TABLE 10

TITLE: AN/ALQ-61 Airborne Intercept System

DESCRIPTION: The AN/ALQ-61 passive receiver system detects, analyzes and stores on magnetic tape, frequency, PW, relative pulse amplitude, and relative bearing of signals received on a first come, first serve, basis over a frequency range of .03 to 14.15 GHZ. Read-out of this information is conducted in the 101C where passive information is correlated with other multi-sensor information. There is no direct read-out provided in the operation of the aircraft.

AVAILABILITY: In combat use in the RA-5C.

QUANTITY: 34 in inventory.

ASSOCIATED PLATFORM: RA-5C

~~SECRET~~

ED-5i

Table 10 to
Annex D to
Appendix E

~~SECRET~~

TABLE 11

TITLE: QRC-315 Microwave Receiving System

DESCRIPTION: A receiving system providing for the detection and display of radar signals in P, S, and C-bands to optimize employment of countermeasures equipment aboard the BROWN CRADLE aircraft.

AVAILABILITY: September 1966

QUANTITY: 19

ASSOCIATED PLATFORM: EB-66B

~~SECRET~~

ED-5j

Table 11 to
Annex D to
Appendix E

~~SECRET~~

TABLE 12

TITLE: BIG LOOK; an airborne high gain accurate D/F system

DESCRIPTION: The utilization of the high gain S-band APS-20 antenna for detection of very weak signals, particularly those radiating from the dummy load of the FAN SONG radar. Used in conjunction with other D/F techniques, the system can accurately detect and locate "dummy load" FAN SONG signals at a distance of 100 miles.

AVAILABILITY: Presently installed, flying in the Vietnam theatre.

QUANTITY: Aboard each EC-121M aircraft, present resources total seven aircraft by July 1967.

ASSOCIATED PLATFORM: EC-121M

~~SECRET~~

ED-5k

Table 12 to
Annex D to
Appendix E

~~SECRET~~

TABLE 13₂

TITLE: BRIGAND; a passive radar detection system

DESCRIPTION: The system utilizes the principle of BiStatic radar; although the concept is not new, its application presented a new technique for location of enemy emitters. As the enemy radar antenna rotates, the intercept equipment is synchronized with the antenna rotation rate so that reception occurs at all times on the BRIGAND scope except when the enemy antenna is pointed directly at the BRIGAND aircraft. In effect, the BRIGAND operator receives somewhat the same picture as the enemy radar operator. Distortion is greatest when the main lobe is perpendicular to the line of sight from the enemy radar antenna to the BRIGAND aircraft.

AVAILABILITY: Flying in the EC-121M aircraft in the Vietnam theatre.

QUANTITY: Seven aircraft by July 1967

ASSOCIATED PLATFORM: EC-121M

~~SECRET~~

ED-51

Table 13 to
Annex D to
Appendix E

~~SECRET~~

TABLE 14

TITLE: GAINTIME Airborne, Air-to-Air Interrogator

DESCRIPTION: GAINTIME is an airborne air-to-air IFF interrogator capable of interrogating MK X IFF signals. Interrogations are fed through a hybrid duplexer and a flexible cable to a special loop antenna mounted near the feed of the X-band APQ-72 antenna.

AVAILABILITY: Now 8 February 1967

QUANTITY: 30. No further manufacture planned because of TEASER I and II development.

ASSOCIATED PLATFORM: Installed in all F-4 aircraft in USS ENTERPRISE Air Wing.

~~SECRET~~

ED-5m

Table 14 to
Annex D to
Appendix E

~~SECRET~~

TABLE 15

TITLE: PHYLLIS ANN - Airborne Radio Direction Finding
(ARDF)

DESCRIPTION: An Airborne System configured with ARDF equipment, special intercept position operated by USAFSS personnel. Provides location of low powered hostile high frequency (HF) radio transmitters that operate between 2-16 MHZ. The basic receiver combined with Doppler, Computer, Compass, and Loran C/D provides a 360 degree direction finding capability with an emitter location accuracy of 580 - 1000 meters when within 10nm of the emitter.

AVAILABILITY: Deployed to South Vietnam

QUANTITY: 53

ASSOCIATED PLATFORM: EC-47

~~SECRET~~

ED-5n

Table 15 to
Annex D to
Appendix E

~~SECRET~~

TABLE 16

TITLE: AN/APR 23; an Airborne Radar Homing Device

DESCRIPTION: A device which provides audio and visual presentation to the pilot for threat electronic emitter signals in the C, S, and X-band. C-band - 4900-5900 MHZ; S-band - 2700-3600 MHZ; X-band - 8500-10,250 MHZ.

AVAILABILITY: In combat since mid 1965 in A-4 aircraft

QUANTITY: 150 purchased

ASSOCIATED PLATFORM: A-4

~~SECRET~~

ED-50

Table 16 to
Annex D to
Appendix E

~~SECRET~~

TABLE 17

TITLE: AN/APR 24; an Airborne Radar Homing & Warning Receiver

DESCRIPTION: A radar homing and warning receiver providing visual and aural presentation to the pilot in the following frequencies:

C-band: 4900 - 5900 MHZ
S-band: 2700 - 3600 MHZ
X-band: 8500 - 10,250 MHZ

AVAILABILITY: In combat since mid 1965

QUANTITY: 50 purchased

ASSOCIATED PLATFORM: F-4 aircraft

~~SECRET~~

ED-5p

Table 17 to
Annex D to
Appendix E

~~SECRET~~

TABLE 18

TITLE: APR-25 RHAW

DESCRIPTION: Radar Homing and Warning Receiver capable of 360 degree detection, identification and display of preselected radar threats and their relative position. System operates in the S, C, and X-band portion of the spectrum and incorporates a heads-up display to the pilot of selected threat for homing.

AVAILABILITY: Installed: 55 in RF-4C, 48 in RF-101, 256 in F-105, and 1 each in F-100, F-104, and EB-66B. Installation started in other aircraft.

QUANTITY: 131 ±

ASSOCIATED PLATFORM: F-4C, RF-4C, F-100, RF-101, F-105, F-104, EB-66B, EB-66C, and B-52D.

~~SECRET~~

ED-5q

Table 18 to
Annex D to
Appendix E

~~SECRET~~

TABLE 19

TITLE: APR-26 Missile Launch Detector

DESCRIPTION: L-band receiver to indicate the launch of the SA-2 GUIDE LINE missile. Provides audio and visual display in addition to identifying specific direction from which site intending to or actually engaged in launching missiles.

AVAILABILITY: Installed: 55 on RF-4C, 48 on RF-101, 256 on F-105, other aircraft being equipped.

QUANTITY: 130/per month production.

ASSOCIATED PLATFORM: EB-66B, EB-66C, B-52D, F-4C, RF-4C, F-100, RF-101, F-105, F-104, and WILD WEASEL III

~~SECRET~~

ED-5r

Table 19 to
Annex D to
Appendix E

~~SECRET~~

TABLE 20

TITLE: AN/APR 28V; Airborne Radar Homing & Warning Receiver

DESCRIPTION: Provides aural and visual presentation to the pilot for threat emitters in the following frequencies:

S-band: 2.7 - 3.6 GHZ
C-band: 4.9 - 5.9 GHZ
X-band: 8.5 - 100 GHZ
L-band: 600 - 1200 MHZ
P band: 70 - 140 MHZ

AVAILABILITY: In combat since mid 1965

QUANTITY: 50 purchased

ASSOCIATED PLATFORM: A-4

~~SECRET~~

ED-5s

Table 20 to
Annex D to
Appendix E

~~SECRET~~

TABLE 21

TITLE: AN/APR-29; Airborne Radar Homing & Warning Receiver

DESCRIPTION: Homing and audio presentation to the pilot are made for threats in the following frequencies:

C-band: 4900 - 5900 MHZ
S-band: 2700 - 3600 MHZ
X-band: 8500 - 10,250 MHZ

AVAILABILITY: In combat since mid 1965

QUANTITY: 50 purchased

ASSOCIATED PLATFORM: RF-8

~~SECRET~~

ED-5t

Table 21 to
Annex D to
Appendix E

~~SECRET~~

TABLE 22

TITLE: ER-133 Panoramic Receiver

DESCRIPTION: High sensitivity tuned RF receiver which simultaneously displays, to WILD WEASEL EWO, all radar signals within 2.0 - 4.0 MHZ. Push button operation permits 360 degree long-range surveillance and/or automatic homing of EW, HF, GCI, AAA, and SAM radars within S-band.

AVAILABILITY: Deployed Southeast Asia (15)

QUANTITY: 55

ASSOCIATED PLATFORM: WILD WEASEL F-105F

~~SECRET~~

ED-5u

Table 22 to
Annex D to
Appendix E

SECRET

TABLE 23

TITLE: ER-142 Panoramic Receiver

DESCRIPTION: Micro Miniturized receiver which displays to EWO of WILD WEASEL all threat radars operating within 2.0 - 4.0 MHZ and 4.06 MHZ. Push button operation permits rapid surveillance and/or automatic homing of EW, HF, GCI, AAA, and SAM radars in S and C-bands. High sensitivity of receiver and antenna configuration permits long-range interception and surveillance in S-band while homing of any selectors threat in C-band (or vice versa) combination of ER-142 and associated RHAW (APR-25 or APJ-107B) provides a "heads-up" display to pilot of selected homing threat.

AVAILABILITY: January 1967

QUANTITY: 53

ASSOCIATED PLATFORM: F-105F, F-4C/D (WILD WEASEL III, IV C, IV D)

SECRET

ED-5v

Table 23 to
Annex D to
Appendix E

~~SECRET~~

TABLE 24

TITLE: ALT-6B

DESCRIPTION: A spot noise jammer used with the ALR-18 to counter X-band airborne radars.

AVAILABILITY: Installed. Is rapidly being replaced by ALT-22, except for X-band version which will remain as part of ALR-18/ALT-6B equipment on B-66 and B-52.

QUANTITY:

ASSOCIATED PLATFORM: B-52, B-66

~~SECRET~~

ED-5w

Table 24 to
Annex D to
Appendix E

~~SECRET~~

TABLE 25

TITLE: ALT-13

DESCRIPTION: A variable bandwidth barrage noise jammer used against EW/GCI and AAA/SA-2 radars in the C and S-bands. Two ALT-13s are required to cover both frequency bands.

AVAILABILITY: Installed

QUANTITY: Six on each B-52
Eight on each B-66B (BROWN CRADLE)
Five on each RB-66C

ASSOCIATED PLATFORM: B-52D, EB-66B

~~SECRET~~

ED-5x

Table 25 to
Annex D to
Appendix E

~~SECRET~~

TABLE 26

TITLE: ALT-15 (Low and High)

DESCRIPTION: A barrage noise jammer used against surveillance radars and communications channels in the 50 - 150 MHZ range for the low band transmitter and 130 - 350 MHZ frequency range for the high band transmitter.

AVAILABILITY: Installed

QUANTITY: Two on each B-52 (1 H, 1 L)
Two on each B-66 (1 H, 1 L)

ASSOCIATED PLATFORM: EB-66B, EB-66C, B-52D

~~SECRET~~

ED-5y

Table 26 to
Annex D to
Appendix E

~~SECRET~~

TABLE 27

TITLE: ALT-16

DESCRIPTION: A barrage noise jammer with a frequency range of 500 - 1000 MHZ used to counter acquisition radars.

AVAILABILITY: Installed

QUANTITY: One on each B-52
One on each B-66

ASSOCIATED PLATFORM: EB-66B, B-52D

~~SECRET~~

ED-5z

Table 27 to
Annex D to
Appendix E

~~SECRET~~

TABLE 28

TITLE: ALT-22

DESCRIPTION: A swept noise jammer with a frequency range of 2500 - 3550 MHZ. Used against S-band SA-2, GCI, AAA, acquisition, and fire control radars.

AVAILABILITY: Installed

QUANTITY: Two on each B-52
Two on each B-66

ASSOCIATED PLATFORM: EB-66B, B-52D

~~SECRET~~

ED-5aa

Table 28 to
Annex D to
Appendix E

~~SECRET~~

TABLE 29

TITLE: AN/ALQ-33 Airborne Jammer

DESCRIPTION: The ALQ-33 is an automatic spot jammer covering the frequency range of 50 to 200 MHz. The receiver searches for a victim signal; tunes to its frequency, and transmits a jamming signal. Automatic look through is provided every one to five seconds.

AVAILABILITY: In use in Southeast Asia

QUANTITY: 111 purchased, 54 delivered to USN Squadrons and the US Marines.

ASSOCIATED PLATFORM: EA-1F

~~SECRET~~

ED-5bb

Table 29 to
Annex D to
Appendix E

~~SECRET~~

TABLE 30

TITLE: AN/ALQ-41 Airborne X-band Track Breaker

DESCRIPTION: The AN/ALQ-41 system provides capabilities for RGPO, conical scan deception, monopulse angular deception and FM-CW speed-gate pull-off. The monopulse angular deception is accomplished by continuously shifting the antennas from circular, horizontal to vertical polarizations. The range to 8.0 to 12.0 GHZ is covered with one band with a peak power output of one to two kw in pulse operation and IW output in CW.

AVAILABILITY: Currently available

QUANTITY: Two per aircraft to provide full coverage

ASSOCIATED PLATFORM: A-3B, RA-3B, EA-3B, A-6A, RA-5C, EA-6A, ALQ-31 POD

~~SECRET~~

ED-5cc

Table 30 to
Annex D to
Appendix E

~~SECRET~~

TABLE 31

TITLE: AN/ALQ-51 Airborne Track Breaker, MOD I

DESCRIPTION: The ALQ-51 is a deceptive track breaker to counter S-band fire control radars which employ pulse ranging, FM-CW wave pulse and conical scan. It also is designed to cause proximity fuzes to detonate prematurely or be duded. The Mod I, AN/ALQ-51 set performs the following functions:

Range gate pull-off
Frequency Translation
Inverse conical scan deception
Angular deception

AVAILABILITY: Installed in the "SHOEHORN" improvement program, now being used in combat.

QUANTITY: 640 sets, all ALQ-51s will be modified to MOD II series commencing 1 February 1967 at a rate of 50/mo

ASSOCIATED PLATFORM: A-3B, RA-3B, EA-3B, EKA-3B, KA-3B, RA-56, A-6A, EA-6A, ALQ-31 POD, A-4, F-4, F-8, RF-4, AN/ALQ-31 POD

~~SECRET~~

ED-5dd

Table 31 to
Annex D to
Appendix E

~~SECRET~~

TABLE 32

TITLE: ALQ-51 (MOD II) Deception Repeater

DESCRIPTION: Automatic deception repeater against ground fire control radars, track while scan radars, and SA-2 missile guidance systems. It functions as a track breaker versus conical scan radars in the frequency range of two to four GHZ. The MOD II in addition consists of multiplexed swept audio. The set performs the following functions:

Multiplexed Swept Audio
Frequency Translation
Range Gate pull-off
Inverse conical scan
Angular deception

AVAILABILITY: 25. Production rate 50/mo starting 1 February 1967, with increased production modification figures until all ALQ-51s are modified by fall 1967.

QUANTITY: 613 MOD I sets to be modified.

ASSOCIATED PLATFORM: A-3B, RA-3B, EA-3B, A-6A, EA-6A, RA-5C, ALQ-31 POD, F-4, A-4, F-8, RF-8, RF-4

~~SECRET~~

ED-5ee

Table 32 to
Annex D to
Appendix E

~~SECRET~~

TABLE 33

TITLE: AN/ALQ-55 Airborne Jammer

DESCRIPTION: The ALQ-55 is an airborne jammer for use against GCI communications and data links. It operates in the 100 to 210 MHz band and jams both voice and data link signals simultaneously. Data link jamming takes priority over voice circuit jamming.

AVAILABILITY: In combat area, but restricted from use.

QUANTITY: 350 in inventory

ASSOCIATED PLATFORM: A-3B, RA-3B, EA-3B, EA-6A, RA-5C

~~SECRET~~

ED-5ff

Table 33 to
Annex D to
Appendix E

~~SECRET~~

TABLE 34

TITLE: QRC-65 Communication Jammer

DESCRIPTION: A spot noise jammer automatically programmed for operation against radars and communication channels in the UHF range (30 - 150 mcs).

AVAILABILITY: Currently installed

QUANTITY: One per aircraft

ASSOCIATED PLATFORM: EB-66B (BROWN CRADLE)

~~SECRET~~

ED-5gg

Table 34 to
Annex D to
Appendix E

~~SECRET~~

TABLE 35

TITLE: ALQ-71 POD Mounted Jammer .

DESCRIPTION: Production model of QRC-160A-1 barrage noise jammer for use against SA-2 and AAA in the 2930 to 3050 MHZ band.

AVAILABILITY: Five in December 1966

QUANTITY: 287 by October 1967

ASSOCIATED PLATFORM: RF-4C, F-4C, F-4D, F-105, EB-66

~~SECRET~~

ED-5hh

Table 35 to
Annex D to
Appendix E

~~SECRET~~

TABLE 36

TITLE: QRC-160-1 POD Mounted Jammer

DESCRIPTION: Barrage noise jammer for use against the SA-2 and AAA threat radars in the 2600 - 3200 MHZ region.

AVAILABILITY: 64

QUANTITY: 117 by May 1967

ASSOCIATED PLATFORM: RF-4C, F-4C, F-4D, F-105, EB-66

~~SECRET~~

ED-511

Table 36 to
Annex D to
Appendix E

~~SECRET~~

TABLE 37

TITLE: QRC-160A-1 POD Mounted Jammer

DESCRIPTION: Modification of the QRC 160-1 barrage noise jammer for improved capability against SA-2 and AAA to provide sawtooth sweeping of noise jamming, 20 MHZ wide from 2930 to 3050 MHZ at rate of 120-128 CPS.

AVAILABILITY: 76 in 1966

QUANTITY: 129 in May 1967

ASSOCIATION PLATFORM: RF-4C, F-4C, F-4D, F-105, EB-66

~~SECRET~~

ED-5jj

Table 37 to
Annex D to
Appendix E

~~SECRET~~

TABLE 38

TITLE: QRC-160-2

DESCRIPTION: Designed to automatically spot jam radar controlled gun layers or airborne interceptors operating in the X-band region (8.5 - 10.3 MHz). The system consists of three receivers and one transmitter, all carried externally in a pod. The receiver sweep searches the band until it locates the frequency of the illuminating radar. The active receiver controls the transmitter and keeps it locked on the frequency of the victim radar. The receiver has a constant look through capability so that the transmitter will continue to track should the radar change frequency.

AVAILABILITY: 28 available for Southeast Asia

QUANTITY: 333 of ALQ-72 (production version) December 1966 through April 1968

ASSOCIATED PLATFORM: F-101, F-100, F-104, F-105

~~SECRET~~

ED-5kk

Table 38 to
Annex D to
Appendix E

~~SECRET~~

TABLE 39

TITLE: QRC-160-4 ECM Pod, Jammer

DESCRIPTION: A pod mounted barrage jammer to be used against surveillance (KNIFE REST A & B, RUS-2) and communications channels in the 65 - 100 MHZ frequency band.

AVAILABILITY: 24 in PACAF

QUANTITY: 24

ASSOCIATED PLATFORM: F-100, F-105

~~SECRET~~

ED-511

Table 39 to
Annex D to
Appendix E

~~SECRET~~

TABLE 40

TITLE: QRC 160-5 ECM Pod, Jammer

DESCRIPTION: A pod containing a modulated noise jammer providing a 30 MHZ band of noise tunable from 550 MHZ to 950 MHZ for use against acquisition radar such as FLAT FACE.

AVAILABILITY: 24 in PACAF

QUANTITY: 24

ASSOCIATED PLATFORM: F-100, F-105

~~SECRET~~

ED-5mm

Table 40 to
Annex D to
Appendix E

~~SECRET~~

TABLE 41

TITLE: QRC-279

DESCRIPTION: A barrage noise jammer operating in the
2500 - 3300 MHZ region.

AVAILABILITY: Installed

QUANTITY: Five

ASSOCIATED PLATFORM: EB-66C

~~SECRET~~

ED-5nn

Table 41 to
Annex D to
Appendix E

~~SECRET~~

TABLE 42

TITLE: AN/ALE-2 Airborne Chaff Dispenser

DESCRIPTION: An external store chaff dispenser used on subsonic aircraft. The dispenser consists of an intervalometer, stripper, control box and case. It holds 192 units of RR-39/AL or RR-44/AL chaff amounting to a total chaff load of 192 pounds. Operation is as follows:

- a. Continuous - 2.5, 10, 20, 40, or 80 tape ft/min
- b. Bursts - 4 to 6 units at 5, 10, 15, or 20 second intervals
- c. Random rate

AVAILABILITY: Now

QUANTITY: 60 Received from USAF, to be installed two for each EKA-3B.

ASSOCIATED PLATFORM: EKA-3B

~~SECRET~~

ED-500

Table 42 to
Annex D to
Appendix E

~~SECRET~~

TABLE 43

TITLE: AN/ALE-18 Airborne Chaff Dispenser

DESCRIPTION: The AN/ALE-18 is an internally installed chaff dispenser capable of discharging either chaff "blooms" or IR forces. It is designed to be charged with 24 rockets which are discharged automatically when direct from the warning receiver. The total load is 24 units which may be all chaff, all IR flares, or any combination thereof. Ejection rate is 12 packages/sec. It holds 12.48 pounds of RR-107 A/G chaff when fully loaded.

AVAILABILITY: In combat in EA-6A and A-6A

QUANTITY: One per aircraft

ASSOCIATED PLATFORM: EA-6A, A-6A

~~SECRET~~

ED-5pp.

Table 43 to
Annex D to
Appendix E

~~SECRET~~

TABLE 44

TITLE: AN/ALE-24 Airborne Chaff Dispenser

DESCRIPTION: The AN/ALE-24 Airborne Chaff Dispenser, pod mounted with each pod containing four tubes, each tube carrying 15 - 30 IR flares or 15 to 32 chaff packages. The equipment functions in three mods of operation: burst, continuous, or DOC-SUD. DOC and SUD merely refer to the size of the chaff package to be dispersed. The DOC package is 2x3x5" and the SUD package is 1x3x5". The basic unit can be modified by reducing the number of tubes/units.

AVAILABILITY:

QUANTITY:

ASSOCIATED PLATFORM: EA-6A pod

~~SECRET~~

ED-5qq

Table 44 to
Annex D to
Appendix E

~~SECRET~~

TABLE 45

TITLE: QRC-142

DESCRIPTION: A folding fin air rocket for transporting and disbursing chaff along a trajectory ahead and below the dispensing aircraft. Chaff is cut to cover X, C, and S-bands with each bundle having an echo area of 1000 square feet. This is the QRC version of the ADR-8 countermeasures rocket.

AVAILABILITY: Installed

QUANTITY: 10,000± (about 40 per a/c)

ASSOCIATED PLATFORM: B-52

~~SECRET~~

ED-5rr

Table 45 to
Annex D to
Appendix E

~~SECRET~~

TABLE 45A

TITLE: QRC-248 IFF Interrogator

DESCRIPTION: An Iff interrogator integrated with ground or airborne surveillance radars to obtain a response, at will, from Soviet-built SRO-2 IFF transponders. The system permits positive identification of hostile aircraft within a distance of 100-250nm.

AVAILABILITY: In Southeast Asia in April 1967 (airborne). To be installed at Monkey Mountain by June 1967. Installed in Southern Tip Operation Ground Radar (Florida).

QUANTITY: Airborne systems for support of SEA - 20. Four systems for support of ADC Southern Tip Operation Radars in Florida (FPS-20).

ASSOCIATED PLATFORM: EC-121 (D/Q) (BIG EYE), FPS-20

~~SECRET~~

ED-5ss

Table 45A to
Annex D to
Appendix E

~~SECRET~~

TABLE 45B

TITLE: AN/APX-76 AIRBORNE IFF Interrogator System a/

DESCRIPTION: Modification to provide air-to-air secure interrogation of aircraft with either present IFF Mark X (SIF) or AIMS, Mk XII, transponders. Gives a positive, unambiguous display correlation of IFF with radar targets. Minimal size and weight makes it practical for interceptor and tactical aircraft.

AVAILABILITY: Eleven Navy F-4Bs on the USS KITTY HAWK; one USAF F-4C and F-4D conducting tests at Nellis AFB. Production calls for 10 in FY 68 and the following schedule in FY 69: June (20), August (30), September (35), October (45) and December (50) and 50 per month thereafter until the following aircraft numbers are equipped (shown under QUANTITY):

QUANTITY:

F-4B	- -	200a/c	F-4E	- -	174 a/c
F-4C	- -	99a/c	F-4J	- -	256 a/c
F-4D	- -	77a/c	P-3	- -	3 a/c

ASSOCIATED PLATFORM: See aircraft and quantities above.

a/ Sole source contract with Hazeltine. Follow-on system for F-111A/B will be designated the APX-69.

~~SECRET~~

ED-5tt

Table 45B to
Annex D to
Appendix E

ELECTRONIC WARFARE EQUIPMENT

AVAILABLE BY FY 1968

RECEIVERS ^{a/}

ALR-23
ALR-28
ALR-29
ALR-30
ASQ-96
QRC-259
QRC-272
QRC-300
QRC-317
QRC-334
QRC-338
EELS
TEASER I & II

RADAR HOMING & WARNING ^{b/}

AAS-17
ALR-21
APR-30
APR-32
APS-107B

JAMMERS ^{c/}

ALT-27
ALQ-76
ALQ-81
ALQ-89
ALQ-92
ALQ-100
ALQ-128
QRC-160-8
QRC-301
QRC-314
QRC-321
QRC-328
QRC-335

EXPENDABLES ^{d/}

XADR-8A
ALE-29
QRC-297

- a/ See Tables 46 through 58.
b/ See Tables 59 through 63.
c/ See Tables 64 through 76.
d/ See Tables 77 through 79.

~~SECRET~~

TABLE 46

TITLE: ALR-23 MLD Receiver

DESCRIPTION: A missile launch detector installed designed to detect the R radiation of a missile launch. The system uses an azimuth scanning receiver rather than operating in a fixed-field like the ALR-21.

AVAILABILITY: Prototype

QUANTITY:

ASSOCIATED PLATFORM: FB-111, retrofit to B-52 G/H being studied.

~~SECRET~~

ED-6a

Table 46 to
Annex D to
Appendix E

~~SECRET~~

TABLE 47

TITLE: AN/ALR 28, a D/F/Panoramic Receiver

DESCRIPTION: This equipment provides signal activity monitoring in X-band from 8 to 10 GHZ with continuous direction finding capability. A sector scan and a narrow band tuning element allow for signal identification and D/F bearing determination of individual signals. It provides visual and audio warning of continuous tracking signals from Airborne Intercept radars. Antenna coverage is 360° in azimuth.

AVAILABILITY: Two each month commencing in June, to a total of 30, with 18 operational.

QUANTITY: 30 total

ASSOCIATED PLATFORM: EKA-3B

~~SECRET~~

ED- 6b

Table 47 to
Annex D to
Appendix E

~~SECRET~~

TABLE 48

TITLE: AN/ALR-29; Jammer Control Receiver

DESCRIPTION: This equipment is similar to the AN/ALR-30 receiver except that it covers 100 MHZ portions of the L and C-bands. The L-band is divided into six incremental bands and the C-band is divided into four incremental bands. A fast sweep panoramic receiver displays all ten incremental (L and C) bands. A manual receiver is provided for each band, L and C. Jammer look through features and D/F are identical to the AN/ALR-30.

AVAILABILITY: First production in May 67, two per month to a total of 30, with 18 operational in the fleet.

QUANTITY: Maximum of 30

ASSOCIATED PLATFORM: EKA-3B

~~SECRET~~

ED-6c

Table 48 to
Annex D to
Appendix E

~~SECRET~~

TABLE 49

TITLE: AN/ALR-30; Jammer Control Receiver

DESCRIPTION: A fast sweep panoramic display receiver capable of displaying all signals from 2.5-3.4 GHZ or any 100 MHZ portion of this band. Two manually tuned receivers are used to select the signals to be jammed. The ALR-30 provides jammer look through capability for monitoring effectiveness. It has an omni antenna and a separate D/F antenna to provide signal bearing. Coincident data from the AN/APR-32 is fed into the ALR-30 for S-band signal identification.

AVAILABILITY: Two each month commencing in May 1967, to a total of 30, 18 operational.

QUANTITY: 30 Total

ASSOCIATED PLATFORM: EKA-3B

~~SECRET~~

ED-6d

Table 49 to
Annex D to
Appendix E

~~SECRET~~

TABLE 50

TITLE: ASQ-96

DESCRIPTION: Semi-automatic superhetrodyne digital control receiver for interception, detection and accurate location ($\pm 1^\circ$) of all signal emitters operating within 500 - 11,000 mcs tactical data is automatically resolved and reported via data link and/or voice.

AVAILABILITY: August 1967

QUANTITY: One (DDR&E approval for nine additional).

ASSOCIATED PLATFORM: EB-66C

~~SECRET~~

ED-6e

Table 50 to
Annex D to
Appendix E

TABLE 51

TITLE: QRC-259 30 MHZ - 40,000 MHZ Receiver

DESCRIPTION: A receiver for the RC-135C to cover the frequency range of 30 MHZ to 18,000 MHZ. It is a superheterodyne, digitally tuned, receiver.

AVAILABILITY: Three prototypes on contract approximately March 1967, available for flight approximately one year from date of contract.

QUANTITY: No production approved.

ASSOCIATED PLATFORM: SAC, RC-135s
USAFSS, ACRP (C-130 & RC-135s)

~~SECRET~~

TABLE 52

TITLE: QRC-272

DESCRIPTION: The QRC-272 is a small (10' x 97"), light-weight (200 lb) pod mounted radar identification and direction finding system. Using an established data base the QRC-272 will identify and generally locate pre-selected threat radars. The collected data will be transmitted via data link on a real time basis to the level of command best able to react to the threat. The system operates in the L, S, C, and X frequency bands.

AVAILABILITY: Prototype January 1967

QUANTITY: NA

ASSOCIATED PLATFORM: F-100; F-105; F-4C/RF-4C;
RF-101; F-111

~~SECRET~~

ED-6g

Table 52 to
Annex D to
Appendix E

TABLE 53

TITLE: QRC-300 Mobile ELINT Van

DESCRIPTION: A Mobile ELINT Data Reduction System to automatically digitize, sort and analyze radar intercept data contained on magnetic tape.

AVAILABILITY: An operational prototype is scheduled for delivery to SAC in February 1967

QUANTITY: one prototype only

ASSOCIATED PLATFORM: In support of U-2 and other special collection platforms.

~~SECRET~~

TABLE 54

TITLE: QRC-317

DESCRIPTION: An airborne receiver to indicate when the aircraft is on the center line of the main beam of the S or C-band SA-2 guidance radar. A SA-2 missile launch warning is also included. The over-all purpose of the system is to provide audio and visual display to the pilot of the presence of an SA-2 guidance signal as well as presenting the strike aircrafts' actual position in the beam of the FAN SONG radar, thus permitting positive evasive maneuvers by the target aircraft.

AVAILABILITY: Possibly 1967

QUANTITY: 10

ASSOCIATED PLATFORM: F-105, F-4C, F-4D, F-4B, EB-66
B-52, C-121

~~SECRET~~

ED-6i

Table 54 to
Annex D to
Appendix E

~~SECRET~~

TABLE 55

TITLE: QRC-334 Compass Strike

DESCRIPTION: Time of arrival (TOA) strike system to provide target location (900') of SAM radars regardless of emission time. Location and identification is accomplished by inverse Loran technique, comparative time of arrival of an emitter pulse at each aircraft within a three aircraft triad. Range to go and MAG heading to target are displayed to pilot.

AVAILABILITY: November 1967

QUANTITY: Three

ASSOCIATED PLATFORM: F-4D

~~SECRET~~

ED-6j

Table 55 to
Annex D to
Appendix E

~~SECRET~~

TABLE 56

TITLE: QRC-338 Passive Ranging

DESCRIPTION: Development of a passive ranging capability to be incorporated into the APR-25.

AVAILABILITY: Development in 1967

QUANTITY: Unknown

ASSOCIATED PLATFORM: WILD WEASEL and aircraft configured with APR-25.

~~SECRET~~

ED-6k

Table 56 to
Annex D to
Appendix E

TABLE 57

TITLE: EELS - Electronic Emitter Location System

DESCRIPTION: EELS is a system of locating ground based electronic pulse emitters with airborne receivers to provide exact positions of these emitters in an easily assimilated form for immediate use by attack aircraft. Radio ranging techniques are used to synchronize cooperation units. Time of receipt of electronic emitter signal is converted to bearing and distance utilizing trilateralization techniques. Following modes of operation possible:

MODE I: Four aircraft, airborne master stations relatively located.

MODE I-A: Four aircraft, airborne master stations geographically located by navigation system such as OMEGA or LORAN.

MODE II: Three or four aircraft and a surface master station geographically oriented.

AVAILABILITY: Now in development, fleet introduction November 1968

QUANTITY: None

ASSOCIATED PLATFORM: E-2A, A-6 or other strike escort aircraft.

~~SECRET~~

TABLE 58

TITLE: TEASER I and II

DESCRIPTION: An airborne interrogation system capable of interrogating MKX, CROSS-UP and SRO-2 IFF systems. Mounted in US interceptor and CAP aircraft, it extends the present IFF interrogators and reduces unknown targets. Primary difference between TEASER I and TEASER II is range capability: 50 miles for TEASER I, 200 miles for TEASER II.

AVAILABILITY: In Development

QUANTITY:

ASSOCIATED PLATFORM: F-8, F-4, F-105

~~SECRET~~

ED-6m

Table 58 to
Annex D to
Appendix E

~~SECRET~~

TABLE 59

TITLE: AN/AAS-17 Infrared Warning Receiver

DESCRIPTION: The AN/AAS-17 consists of four aft-looking infrared sensors with a fixed field of view 100° x 100° for IR detection of missile firings. Two sensors are mounted in each of the wing tip Pods on Tactical Fighter Aircraft.

AVAILABILITY: One flight test model

QUANTITY: Fleet buy not yet authorized, quantity undetermined.

ASSOCIATED PLATFORM: F-105D, F-105F

~~SECRET~~

ED-6n

Table 59 to
Annex D to
Appendix E

~~SECRET~~

TABLE 60

TITLE: AN/ALR-21 Infrared Warning Receiver & Missile Launch Detector

DESCRIPTION: The ALR-21 consists of six AFT-looking infrared sensors with a fixed field of view for detection of AAM launchings.

AVAILABILITY: Flight testing February 1967.

QUANTITY: Production not approved.

ASSOCIATED PLATFORM: B-52G/H; B-66

~~SECRET~~

ED-60

Table 60 to
Annex D to
Appendix E

TABLE 61

TITLE: AN/APR 30 Radar Warning and Homing Receiver

DESCRIPTION: Homing and audio presentation to the pilot for threats in the following frequencies:

	<u>S-band</u>	<u>C-band</u>	<u>X-band</u>
Homing	2.5 - 3.6 GHZ	4.9 - 5.9 GHZ	8.5 - 10.0 GHZ
Warning	2.0 - 4.0 GHZ	4.0 - 8.0 GHZ	8.0 - 11.0 GHZ

AVAILABILITY: Prototype being tested as of February 1967.
Production commences upon Navy acceptance.

QUANTITY: Production rates 10 per week commencing June 1967.

ASSOCIATED PLATFORM: Navy F-4B

~~SECRET~~

TABLE 62

TITLE: AN/APR-32 SAM Warning Receiver

DESCRIPTION: A sweep lock automatic receiver for determining the presence of SA-2 command guidance link signals for missile status and warning purposes. Indicator lights show the presence of signals and missile launch status. A coincidence signal is sent to the AN/ALR-30 for rapid identification and D/F of the tracking signal.

AVAILABILITY: Two per month, commencing June 1967, to a total of 30; 18 operational.

QUANTITY: 30 maximum.

ASSOCIATED PLATFORM: EKA-3B

~~SECRET~~

ED-6q

Table 62 to
Annex D to
Appendix E

~~SECRET~~

TABLE 63

TITLE: APS-107B RHAW Receiver

DESCRIPTION: A Radar Homing and Warning system which provides 360° warning and relative bearing of threat radars in the S, C and X-bands. The system also indicates the GUIDE LINE missile launch.

AVAILABILITY: September 1967.

QUANTITY: 737.

ASSOCIATED PLATFORM: F-4D and WILD WEASEL

~~SECRET~~

ED-6r

Table 63 to
Annex D to
Appendix E

~~SECRET~~

TABLE 64

TITLE: AN/ALT-27 Airborne Noise Jammer

DESCRIPTION: A high power, noise modulated, Backward Wave oscillator jammer featuring plug-in oscillator modules to cover the frequency range of 350 MHZ to 11 GHZ in 11 bands. It has automatic frequency control to hold its set frequency within half of its spot band width, allowing more power to be transmitted over a narrow band without drifting. It can be gated on and off in micro-seconds for receiver look through. A steerable antenna increases its effectiveness and is controlled with the DAC-723971 Directional Antenna Control.

AVAILABILITY: Two per month commencing March 1967; total for 30 aircraft with 18 operational; two AN/ALT 27s per aircraft.

QUANTITY: 60 installed in the 30 EKA3Bs.

ASSOCIATED PLATFORM: EKA 3B

~~SECRET~~

ED-6s

Table 64 to
Annex D to
Appendix E

TABLE 65

TITLE: AN/ALQ-76 Airborne Jammer System

DESCRIPTION: The ALQ-76 is a Pod mounted airborne jammer system operating in the .7 to 11 GHZ band remotely controlled and capable of carrying any four of nine interchangeable jammers. The following table lists the frequency coverage of each band:

Sub band	1	.7 - 1.0 GHZ	4A	2.7 - 3.3 GHZ
	1	1.0 - 1.4 GHZ	5	3.5 - 4.85 GHZ
	2	1.3 - 1.85 GHZ	6	4.8 - 6.55 GHZ
	3	1.8 - 2.55 GHZ	7	6.5 - 8.55 GHZ
	4	2.5 - 3.55 GHZ	8	8.5 - 11.0 GHZ

AVAILABILITY: In development.

QUANTITY: Four.

ASSOCIATED PLATFORM: EA-6A and others

~~SECRET~~

TABLE 66

TITLE: AN/ALQ-81 Airborne Track Breaker

DESCRIPTION: The AN/ALQ-81 is a Pod mounted version of the ALQ-100 remotely controlled from the aircraft and powered by an air turbine motor internally mounted in the Pod. Operating frequencies are 1.8 - 8.0 GHZ for pulse radars and 4.0 - 8.0 GHZ for CW radars.

AVAILABILITY: Production commenced in March 1967.

QUANTITY: 140 have been ordered, by July 1967 a total of 63 will be delivered.

ASSOCIATED PLATFORM: A-1 and others.

~~SECRET~~

ED-6u

Table 66 to
Annex D to
Appendix E

TABLE 67

TITLE: AN/ALQ-89 Airborne VHF Jammer

DESCRIPTION: An exact duplicate of the AN/ALQ 92 except that the power unit will be the smaller power unit now in the AN/ALQ 55. This is an interim measure to be employed until the AN/ALQ 92 is set into production.

AVAILABILITY: The first five EKA-3B will contain the equipment, later to be retrofitted with the ALQ 92.

QUANTITY: Very limited production.

ASSOCIATED PLATFORM: EKA 3B

~~SECRET~~

TABLE 68

TITLE: AN/ALQ-92 Receiver Jammer

DESCRIPTION: This equipment jams from 60-165 MHz for radar, and 100-165 MHz for communications. It is basically the AN/ALQ-55 system with the automatic features removed, displays added, and a larger power output provided. The receiving portion contains a fast sweep, panoramic display and seven manually tuned receivers. The same antennas are used for jamming and reception, and the set has look through, variable jamming band widths and a power output of 1500 watts.

AVAILABILITY: Prototype.

QUANTITY: Eighteen will be delivered to the fleet, spares and support equipment will follow.

ASSOCIATED PLATFORM: EKA3B Aircraft.

~~SECRET~~

ED-6w

Table 68 to
Annex D to
Appendix E

~~SECRET~~

TABLE 69

TITLE: AN/ALQ-100 Airborne DECM Set

DESCRIPTION: The ALQ-100 is an internally installed deception device designed to provide azimuth, elevation, and range deception against fire control radars. The ALQ-100 operates in the 1.8 - 8.0 GHZ band for pulse radar and 4.0 - 8.0 GHZ band for CW radars. The ALQ-100 will simultaneously deceive radars in one or more frequency bands or modes of operation. It will also prematurely detonate or dud CW proximity fuses in SAM, AAM, or AAA projectiles.

AVAILABILITY: First production March 1967.

QUANTITY: Total ordered is over 1000 sets, production commences three per month in March 1967, 84 by July, 204 by September 1967.

ASSOCIATED PLATFORM: Navy fighter and attack aircraft.

~~SECRET~~

ED-6x

Table 69 to
Annex D to
Appendix E

~~SECRET~~

TABLE 70

TITLE: QRC-128

DESCRIPTION: A transponder system designed to provide automatic operation against communications and data link channels in the 100 - 160 MHz region. Three systems will be "design Approval Tested" and designated AN/ALQ-59.

AVAILABILITY: April 1967(@ 4/per month).

QUANTITY: 15 - QRC-128
THREE - ALQ-59s

ASSOCIATED PLATFORM: B-52, EB-66, EC-121

~~SECRET~~

ED-6y

Table 70 to
Annex D to
Appendix E

~~SECRET~~

TABLE 71

TITLE: QRC-160-8 POD Mounted Jammer

DESCRIPTION: A POD mounted noise jammer which simultaneously cover S and C-band SA-2 radars and S-band AA radars.

AVAILABILITY: July 1967.

QUANTITY: 20/month starting July 1967 for total of 180.

ASSOCIATED PLATFORM: F-105, F-4C & D, F-100, RF-101

~~SECRET~~

ED-6z

Table 71 to
Annex D to
Appendix E

~~SECRET~~

TABLE 72

TITLE: QRC-301

DESCRIPTION: A deception repeater, mounted on the side of a weapon pylon, for use against S-band AAA and SA-2 radars. Prototype flight test with WILD WEASEL III Aircraft.

AVAILABILITY: One Prototype.

QUANTITY: No Production Planned.

ASSOCIATED PLATFORM: WILD WEASEL III (F-105F) (F-105D).

~~SECRET~~

ED-6aa

Table 72 to
Annex D to
Appendix E

~~SECRET~~

TABLE 73

TITLE: QRC-314

DESCRIPTION: A fuze jammer to predetonate the proximity fuze in the SA-2 missile. The Jammer covers a frequency range of 3,600 - 3,800 MHZ.

AVAILABILITY: Two Prototypes will complete flight testing by April 1967.

QUANTITY: No fleet retrofit plans as yet.

ASSOCIATED PLATFORM: F-105, F-4C, B-52

~~SECRET~~

ED-6bb

Table 73 to
Annex D to
Appendix E

~~SECRET~~

TABLE 74

TITLE: QRC-321

DESCRIPTION: A dual mode deception jammer to operate against AAA and track while scan (TWS) radars operating between 2.6 - 5.2 GHZ. The system utilizes multiple false targets with one mode and a repeater technique in the other mode. The system is housed in two half cylinders mounted on the side of the fuselage.

AVAILABILITY: May 1967.

QUANTITY: 14 by October 1967.

ASSOCIATED PLATFORM: F-105F (WILD WEASEL)

~~SECRET~~

ED-6cc

Table 74 to
Annex D to
Appendix E

~~SECRET~~

TABLE 75

TITLE: QRC-328

DESCRIPTION: Development of an X, C and S-band deception jammer for the B-52 and EB-66. Main features are exceptional high power, lateral deception techniques including a multiple false target mode.

AVAILABILITY: Definition phase.

QUANTITY: Intended for B-52 and B-66 retrofit numbers not determined.

ASSOCIATED PLATFORM: B-52, B-66

~~SECRET~~

ED-6dd

Table 75 to
Annex D to
Appendix E

~~SECRET~~

TABLE 77

TITLE: XADR-8A CHAFF ROCKET

DESCRIPTION: XADR-8A is a forward launched folding fin air rocket containing 20 chaff units cut to counter X, C and S-band radars. It is a 2:75" rocket designed for the ALE-25 POD. The B-52 would have two PODs containing 12 rockets each.

AVAILABILITY: March 1967.

QUANTITY: 14,000 rockets in production.

ASSOCIATED PLATFORM: B-52 G/H

~~SECRET~~

ED-6ff

Table 77 to
Annex D to
Appendix E

~~SECRET~~

TABLE 78

TITLE: AN/ALE-29 Airborne Chaff Dispenser

DESCRIPTION: A chaff dispenser consisting of 30 tubular aluminum discharge tubes brazed together in rows of five. Chaff actuation occurs by electrical ignition of explosive charges which fire the chaff into the airstream. This device can also deploy infrared flares.

AVAILABILITY: Entering production March 1967.

QUANTITY: FY 68: 240 sets; FY 69: 1200 sets.

ASSOCIATED PLATFORM: A-4, F-4 already configured for set installation.

~~SECRET~~

ED-6gg

Table 78 to
Annex D to
Appendix E

~~SECRET~~

TABLE 79

TITLE: QRC-297

DESCRIPTION: An effort to procure disposable jammers with a 1,250 - 1,350 MHZ frequency range compatible with the RR-72 Chaff package.

AVAILABILITY: Flight test February 1967.

QUANTITY: 200 Units.

ASSOCIATED PLATFORM: B-52, EB-66, F-4E, F-4B, EB-47, EA-6A

~~SECRET~~

ED-6hh

Table 79 to
Annex D to
Appendix E

~~SECRET~~

ELECTRONIC WARFARE EQUIPMENT AVAILABLE AFTER FY 1968^{a/}

ATEWS

QRC-239

QRC-299

QRC-294A

XADR-7A

XADR-9

TRISAT

EARS

a/ See Tables 80 through 87

~~SECRET~~

ED-7

TABLE 80

TITLE: Advanced Tactical Electronic Warfare System (ATEWS)

DESCRIPTION: The purpose of the ATEWS will be to provide active and passive electronic warfare support to USAF tactical fighter, attack, reconnaissance, airlift, and friendly ground and naval forces. The ATEWS will provide the following capabilities:

1. Airframe:

- a. A Mach number sufficient to escort and penetrate with combat forces.
- b. A minimum range of 2000nm at an optimum cruise altitude of 35,000 feet.
- c. Air refuelable.
- d. Short field operation (5000ft runway at field elevation of 5000 ft).
- e. World-wide deployment on short notice.

2. Electronic Warfare System:

- a. Electronic jammers able to simultaneously counter at least four threat radars in the same frequency band and screen the strike force at a distance of 30nm from the enemy radars. Frequency coverage of all threat radars is desired.
- b. A passive electronic warfare system to determine type and location of threat radars for selective and effective use of directional active systems.
- c. Expendable countermeasures (Chaff, chaff/flare rockets) to counter immediate threats.

The primary users of the ATEWS will be TAC, USAFE, and PACAF.

AVAILABILITY: Contract definition - FY 1967
Prototype development - FY 1968
Initial operational capability - CIRCA 1972

~~SECRET~~

QUANTITY: Unknown

ASSOCIATED PLATFORM: Unknown

~~SECRET~~

ED-7b

Table 80 to
Annex D to
Appendix E

SECRET

~~SECRET~~

TABLE 81

TITLE: QRC-239

DESCRIPTION: Investigation of techniques (other than receiver-flare combinations) capable of defending aircraft against infrared guided missiles. Exploratory developed projects under supervision of the Air Force Avionic Laboratory.

AVAILABILITY: NA

QUANTITY: NA

ASSOCIATED PLATFORM: Study

~~SECRET~~

ED-7c .

Table 81 to
Annex D to
Appendix E

~~SECRET~~

TABLE 82

TITLE: QRC-299

DESCRIPTION: Deception equipment designed to saturate the AGC of AI radars and missile seekers in the X-band.

AVAILABILITY: One

QUANTITY: One

ASSOCIATED PLATFORM: KC-135 used as test bed.

~~SECRET~~

ED-7d

Table 82 to
Annex D to
Appendix E

~~SECRET~~

TABLE 83

TITLE: QRC-294A (Coronet Solo-Broadcast Jamming System)

DESCRIPTION: Airborne system to jam or disrupt multiple frequency commercial television and radio broadcast stations operated by hostile forces. Countermeasure equipment will perform against LF, MF, HF, VHF, UHF, data link and TV stations operating between five KC and 350 MCS.

AVAILABILITY: January 1968.

QUANTITY: Four.

ASSOCIATED PLATFORM: C-121-C

~~SECRET~~

ED-7e

Table 83 to
Annex D to
Appendix E

~~SECRET~~

TABLE 84

TITLE: XADR-7A Radar Cross-Section Simulator

DESCRIPTION: The XADR-7A is a 2.75" forward launched rocket decoy which simulates the radar cross-section and speed of a B-52. The decoy rockets are designed to operate at altitudes of 10,000 to 40,000 feet for the purpose of saturating the fire control radars of the SA-2 SAM system. The system will consist of two PODS each with eight rockets.

AVAILABILITY: 1970.

QUANTITY: No funding approved for production.

ASSOCIATED PLATFORM: B-52 G/H

~~SECRET~~

ED-7f

Table 84 to
Annex D to
Appendix E

~~SECRET~~

TABLE 85

TITLE: XADR-9 Chaff/Flare Rocket

DESCRIPTION: The XADR-9 is a forward launched folding fin air rocket containing 10 chaff units and a flare. The chaff is cut to counter X, C and S-band radars. The flare is to counter IR air-to-air missiles.

AVAILABILITY: In development. Available if needed by 1968.

QUANTITY: NA

ASSOCIATED PLATFORM: B-52 G/H

~~SECRET~~

ED-7g

Table 85 to
Annex D to
Appendix E

~~SECRET~~

TABLE 86

TITLE: Target Recognition Through Integrated Spectral Analysis Technique (TRISAT)

DESCRIPTION: The radar returns from a maximum of 10 selected airborne targets are fed into a computer. Since each return from a target aircraft is unique, by model, the return signals are sorted and compared digitally with other actual signals stored in the computer. Display techniques are used to provide identification.

AVAILABILITY: In development.

QUANTITY: None.

ASSOCIATED PLATFORM: Interceptor aircraft.

~~SECRET~~

ED-7h

Table 86 to
Annex D to
Appendix E

TABLE 87

TITLE: Electromagnetic and Aircraft Radiation System (EARS)

DESCRIPTION: An airborne system consisting of a computer which receives incoming radar signals from an airborne target, and compares this signal with stored information in the computer. Since each return from a target aircraft model is unique, the digital comparison can be used for target identification. A maximum of four identifications presentations to the pilot will be available.

AVAILABILITY: In development.

QUANTITY: None.

ASSOCIATED PLATFORM: Interceptor aircraft.

~~SECRET~~

ANNEX E TO APPENDIX E

ENEMY ELECTRONIC COUNTER COUNTERMEASURES
(ECCM) SUMMATION

1. (S) The Joint Chiefs of Staff, in a message MJCS 405-66, dated 29 December 1966, directed the Services to submit studies to the Joint Chiefs of Staff regarding possible improvements which could be made (or anticipated) in the SA-2 system to offset or neutralize US IRON HAND missions or other ECCM techniques which could be employed by the North Vietnamese to improve their Air Defense System. The Services responded with detailed reports.

2. (U) A review of these reports has been made by the NIGHT SONG Study Group. By necessity only a small amount of material could be extracted; for purposes of brevity, technical details in depth have not been included.

3. (S)



AT

~~SECRET~~

EE-1

Annex E to
Appendix E

~~SECRET~~

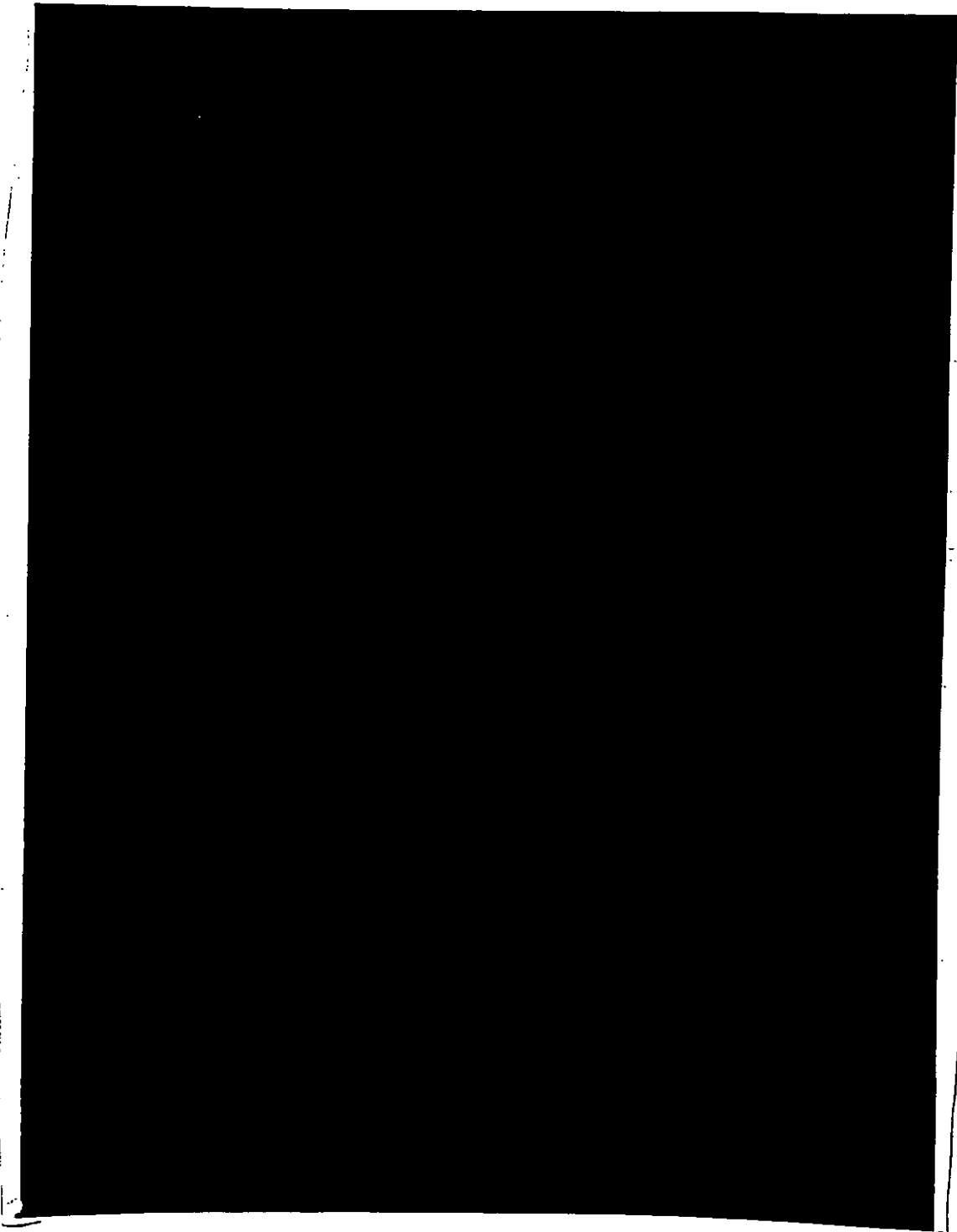

~~SECRET~~

EE-2

Annex E to
Appendix E

~~SECRET~~

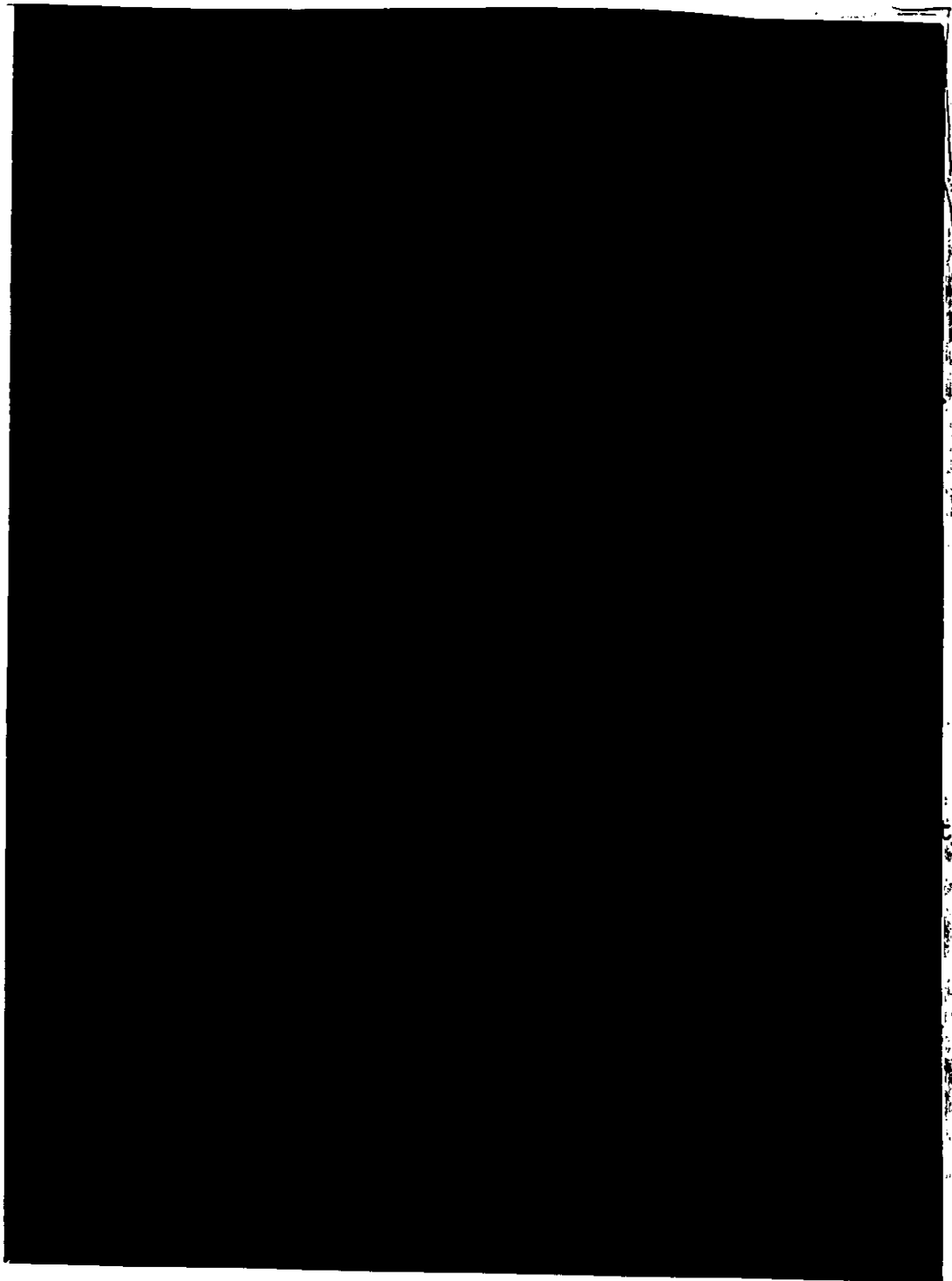

AI

~~SECRET~~

EE-3

Annex E to
Appendix E

~~SECRET~~

A-4

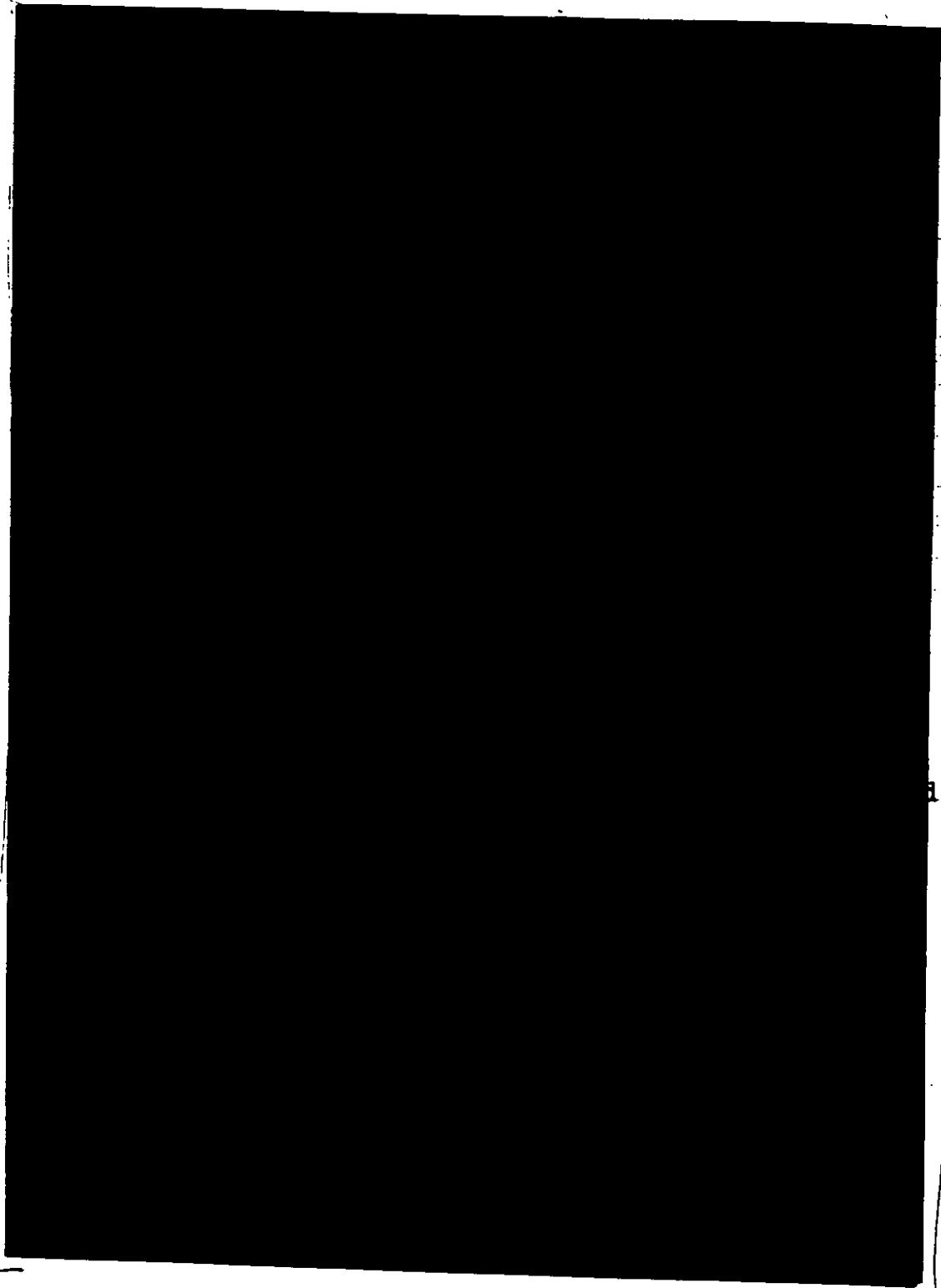

~~SECRET~~

EE-4

Annex E to
Appendix E

1 2 3 4 5 6 7 8 9 10 11 12 13 14 15 16 17 18 19 20 21 22 23 24 25 26 27 28 29 30 31 32 33 34 35 36 37 38 39 40 41 42 43 44 45 46 47 48 49 50 51 52 53 54 55 56 57 58 59 60 61 62 63 64 65 66 67 68 69 70 71 72 73 74 75 76 77 78 79 80 81 82 83 84 85 86 87 88 89 90 91 92 93 94 95 96 97 98 99 100

~~SECRET~~

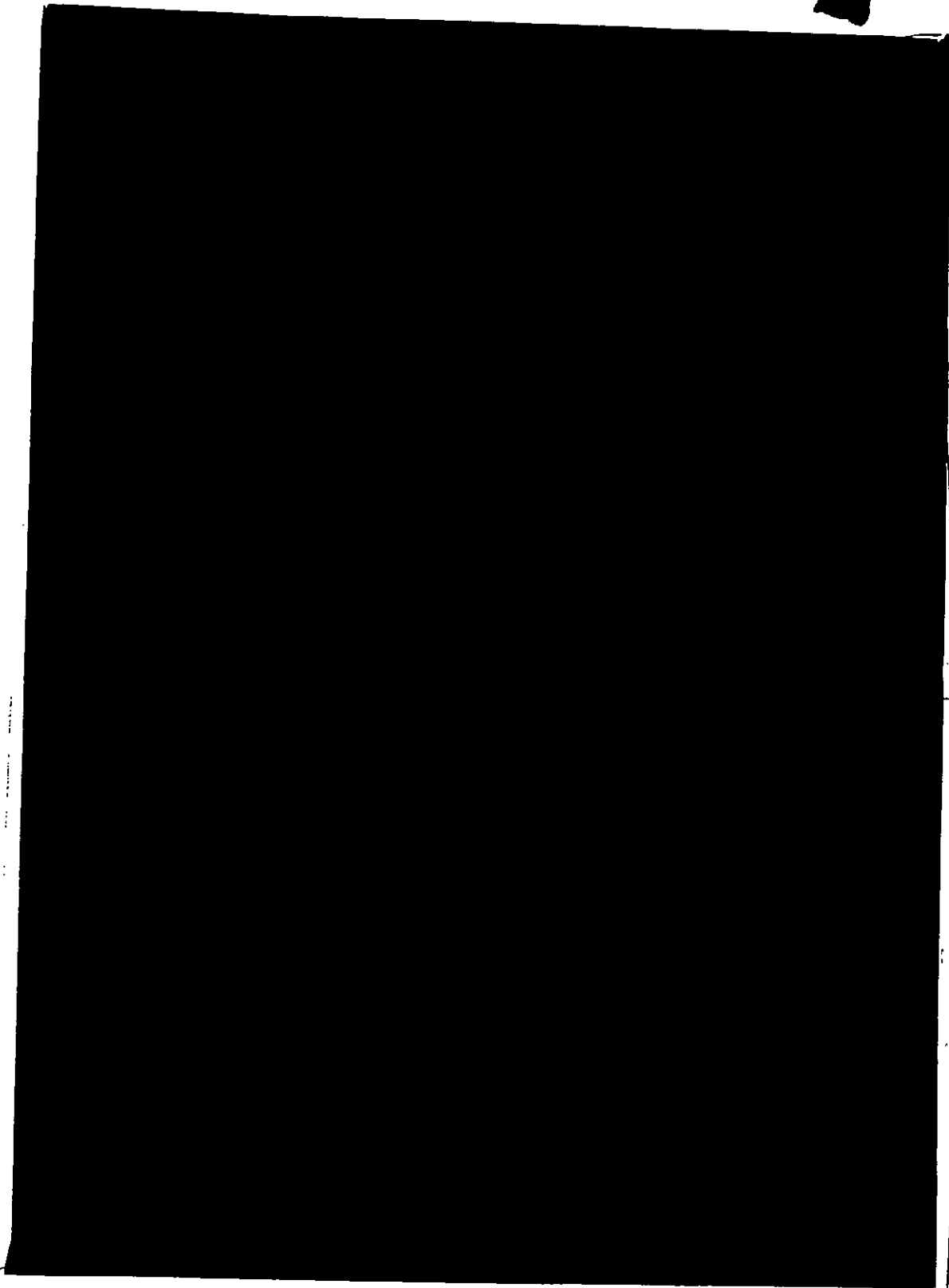

A1

~~SECRET~~

EE-5

An E to
Appendix E

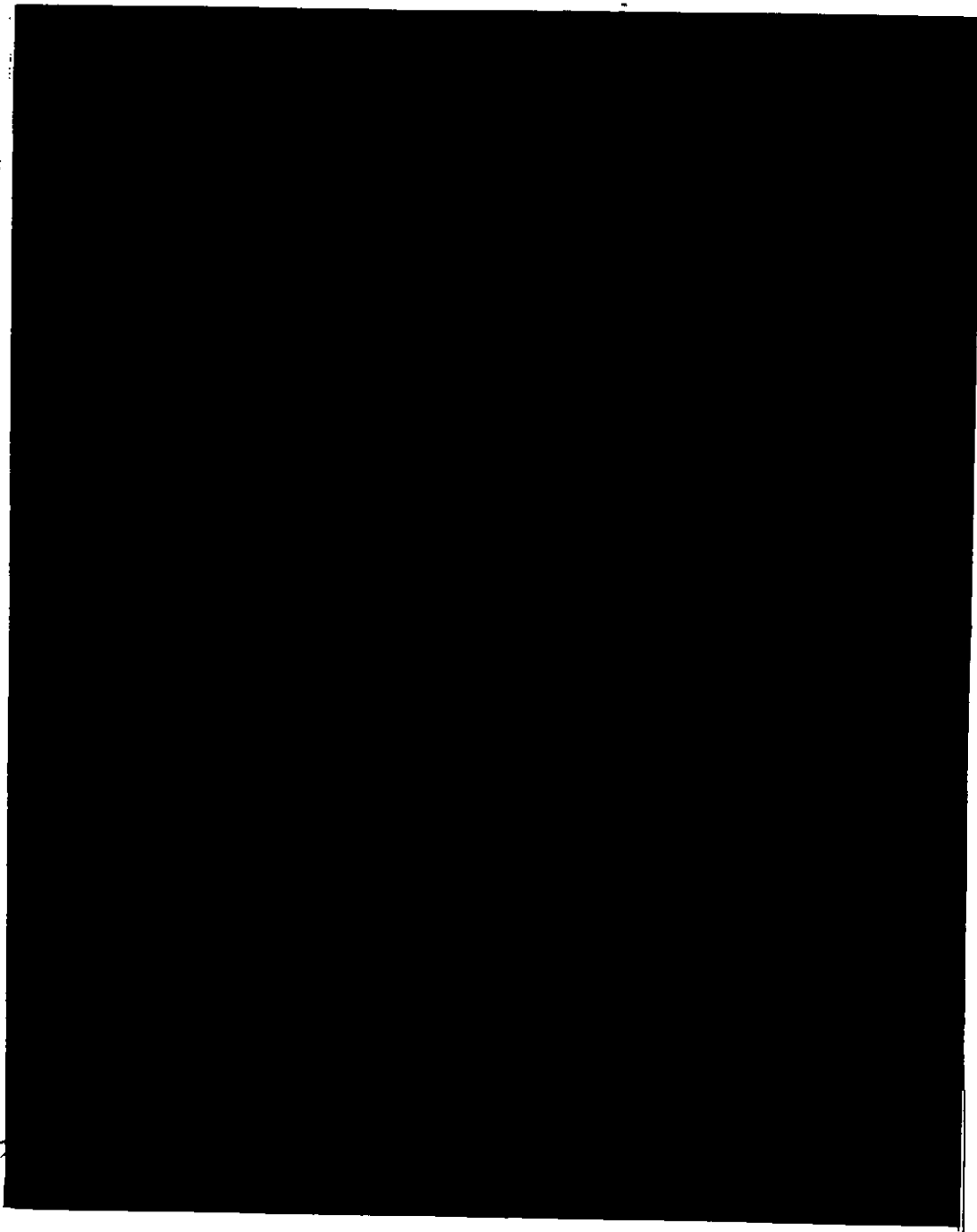

7/12

~~SECRET~~

APPENDIX F

CURRENT TACTICS

1. (S) Since the beginning of air operations over North Vietnam, US air tactics have been characterized by their changing nature. Existing tactics have been modified and new tactics developed to achieve the objective of maximum strike effectiveness with minimum costs, in terms of aircraft/aircrew attrition, in the face of continually improving enemy air defense capability.

a. Where existing tactics resulted in relatively high aircraft attrition rates, changes were made in penetration altitudes, evasive maneuvers, delivery tactics, weaponeering, and/or equipment.

b. Losses of aircraft to enemy light AAA and automatic weapons, required raising the minimum operating altitudes and limited the number of passes on the target.

c. As the MIG threat increased, MIG CAP and escort of strike forces became necessary.

d. Introduction of the surface-to-air missile (SA-2) dictated the installation of radar homing and warning (RHAW) equipment in all strike aircraft for SA-2 warning, the organization of IRON HAND operations to attack SA-2 sites, and the restriction of operation within SA-2 defended areas to VFR conditions. With the introduction of active electronics countermeasures (ECM), operating altitudes within SA-2 areas were raised.

e. Other changes in tactics have been made by the introduction of the A-6A and MSQ-77 for night and inclement weather operations.

f. Generally, tactics of US tactical air forces are similar and there are few significant differences in the basic tactical concepts of the units of the 7th FLT and the 7th AF. Most of these are brought about by differences in base location or equipment capabilities.

~~SECRET~~

2. (S)The primary consideration in the determination of our air tactics generally has been the continuing evolution of enemy air defenses. However, there have been other factors that have been important considerations in shaping over-all tactical operations. These factors are:

a. Capabilities of US Tactical and Support Forces.

With the exception of shortcomings in the night and all-weather area, our tactical aircraft and crews have been capable of completing assigned tasks. The gradual build-up of forces, though not the only degrading factor, prevented the use of sufficient mass to overwhelm enemy air defenses at the outset coincidentally with destruction of assigned targets. Capabilities such as aircraft speed, maneuverability, range, munitions load, and installed navigation equipment are important factors in determining tactics.

b. Constraints. Geographical limitations to the operating area created by the buffer zone and restricted areas limit the territory available for entry and exit of strike forces and orbit areas available to ECM and ELINT supporting forces. Targeting restraints on enemy airfields directly affect the numbers of escort (CAP) aircraft required. If the enemy airfields were destroyed, the remaining aircraft would be forced to operate from Chinese bases. This would decrease the time they could remain on defensive CAP, degrade their command and control capability and increase their reaction time. The over-all degradation to the interceptors force would enhance our MIG CAP operations.

c. Electronic Countermeasure. In the past, the scheduling of strike forces into heavily defended areas has been dictated, to a degree, by the availability of ECM support aircraft. Recent improvements in ECM support capability and the installation of on-board defensive ECM equipment for fighter aircraft has resulted in better protection for the strike forces and more flexibility in mission planning.

d. Weather. The combination of missile, AAA automatic weapons and MIG defenses has caused the establishment of minimum weather requirements of 10,000 feet ceiling and five miles visibility in SA-2 defended areas over North Vietnam. The limited time daily when

these conditions exist makes it necessary to schedule a maximum effort for each strike mission rather than scheduling smaller strike missions at random periods throughout the day. Such conditions add to the degree of predictability caused by other factors such as refueling tracks and time-over-targets dictated by turnaround missions.

e. Munitions Availability and Effectiveness. Our efforts to neutralize the enemy's air defense system have been seriously handicapped because the munitions which are most effective in destroying AAA, automatic weapons, SA-2 battalions and radars are scarce and because we have had difficulty in accurately locating the defenses. The density of automatic weapons and light AAA existing in most of North Vietnam dictates weapons delivery methods which permit release and recovery above the effective range of these weapons. Operating techniques and the use of electronics countermeasures, radar homing and warning, and IRON HAND support have allowed the strike force to operate in high threat areas with minimal losses from missiles. (See Appendix H.) Strike pilots are in agreement that the primary strike delivery method must be one that permits operating outside the effective range of light AAA and automatic weapons.

3. (S) A general discussion of tactics employed by the USN/USAF categorized by mission and as affected by the NVN Air Defense System follows:

a. Lightly Defended Targets Outside Missile Envelope. When striking lightly defended targets outside of the missile envelope, enroute penetrations are normally at best cruise altitude (above 15,000). When over these targets, bombing, rocket, and strafing runs are carried to low release and firing altitudes (below 4500') to improve delivery accuracy. In addition, multiple runs can be made to increase probability of target destruction. It is to be noted that few such targets remain in North Vietnam.

b. Heavily Defended Targets Outside Missile Envelope. Tactics employed against heavily defended targets are more restrictive. Enroute altitudes are above the effective range of the light AAA/AW and weapons delivery is limited primarily to steep dives (40 degrees to

60 degrees) with a release altitude that permits the aircraft to bottom out above the effective range of automatic weapons and 37mm AAA. Normally, only one pass is made on heavily defended targets and flak suppression is generally used.

c. Targets Within Missile Envelope. Tactics for those targets which are within the surface-to-air missile envelope are essentially the same as for heavily defended targets except IRON HAND elements are included in the force. Penetration tactics may vary among units depending upon terrain and density of enroute defenses. The majority of naval units penetrate at 9000 feet or above in order to remain above the effective range of automatic weapons and 37mm AAA. USAF aircraft equipped with electronic countermeasure devices penetrate at 6,000-17,000 feet. Low altitude penetrations (100-400 feet) are used for night A-6 and RF-4C missions. However, low altitude penetrations require very precise planning and execution. Routes are planned to avoid populated areas and AAA concentrations and are normally flown to take advantage of terrain masking and to evade radar detection. More support aircraft are required for strikes penetrating the missile envelope, especially those attacking targets located north of the 20th parallel where MIGCAP is required. Normal support requirements include flak suppression, electronic warfare, escort, CAP, IRON HAND, SAR, and tanker aircraft.

d. Flak Suppression. In the early months of the war, napalm, 20mm, CBU-2A and rockets were used for flak suppression. Runs were carried into minimum range and altitude affording the enemy gunner a no-deflection short range target. In addition, many targets were so heavily defended that the number of aircraft available precluded attacking more than a few of the occupied flak sites. The mobility of NVN AAA also contributed in reducing effectiveness of flak suppression. Because AAA is constantly moved from site to site, suppression pilots had difficulty and at times were unable to visually acquire the occupied sites prior to roll-in. These factors combined to make flak suppression a costly venture in terms of results achieved, and the use of flak suppression was reduced to a minimum. With the

advent of the CBU-24, proximity fuzed BULLPUP and proximity fuzed low-drag bombs, employment of flak suppression has been resumed. Comments from the field reveal that results have been excellent, due primarily to the area coverage afforded by these weapons.

e. IRON HAND

(1) Navy. Current tactics employ two IRON HAND plus two SHRIKE (A-4, A-6) aircraft which precede or accompany the strike aircraft to the target area. Known SAM sites which could pose a threat to the striking force, are plotted and studied prior to launch. The SHRIKE aircraft utilize the APR-23/SHRIKE direction finder capability to detect radiating FAN SONG radars. The pilot then maneuvers into estimated SHRIKE range of the FAN SONG and launches his missile. Ordnance employed by IRON HAND attack aircraft include bombs and rockets. Currently only SAM batteries which threaten specific US operations in Route Packages IV and VI are attacked; elsewhere SAM batteries are attacked when located. It is thought likely that the enemy has been able to identify SHRIKE aircraft to some extent since SA-2 activity has frequently been reduced when SHRIKE aircraft accompany the strike units.

(2) Air Force. USAF IRON HAND operations are conducted by WILD WEASEL units composed of two WILD WEASEL and two IRON HAND aircraft. The WILD WEASEL, two-place F-105F is configured with (APR-25/26) radar homing and warning system which provides 360 degrees automatic detection, identification, and directional display of SAM, AAA, and AI emitters. The EWO has the capability of selecting and homing on any EW, GCI, HF, SAM, or AAA radar in the S and C-bands. The EWO can automatically clear the pilots RHAW scope momentarily of all signals except the selected target radar, enabling quick crew orientation. The notification of environment and course directions required for homing and/or avoidance are passed to the pilot by the EWO, leaving the pilot free to concentrate on the major mission of maneuvering to the target. When a SAM site is selected for homing, the EWO automatically transposes that SAM site to the pilot's gun

sight in a display of the actual azimuth/elevation of the site. The heads up display assists the pilot in visual acquisition of the site and precludes any further requirement for head in the cockpit. WILD WEASEL aircraft remain at 15,000-17,000 feet altitude from the tanker to penetration of the terminal area, then descend to 6,000-9,000 feet altitude, accelerating to approximately 520 kts with a lateral separation of 1500 feet and 500-1000 feet vertical separation. Active jamming (QRC-160) is initiated upon the first display of a SAM missile warning which is a threat to the cell formation. As strike aircraft proceed toward the assigned target, the WILD WEASELS commence maneuvering for homing on the threat site and SHRIKE attack when within the SHRIKE envelope.

(3) The North Vietnamese capability to rapidly relocate SAM batteries, to effectively camouflage both SAM and other radars, and the employment of radar emission control (EMCON) techniques (seven to ten seconds radiation time) are major problems in IRON HAND operations. SHRIKE performance has been degraded as there is currently no method of accurately measuring the range to enemy radars.

f. Anti-MIG Tactics

(1) US aircraft which operate within the normal MIG operating area are provided protection in the form of MIGCAP, BARCAP, TARCAP and escort aircraft. These counter-air forces consist primarily of the USAF F-4C and the Navy F-4B/F-8 aircraft. The fighters are positioned between the known or suspected enemy threat and friendly aircraft.

(2) Tactics utilized for the most part have been of the day visual fighter type since the lack of positive radar identification of enemy aircraft requires visual identification before opening fire. The ensuing encounters have resulted in a loss ratio of about three MIGs to one friendly aircraft destroyed. Although this US/MIG kill ratio has been favorable and the MIGs have only destroyed a relatively small number of US aircraft, they have had a considerable impact on our mission accomplishment by:

(a) Causing friendly aircraft to abort or jettison ordnance prior to reaching target. (USAF study shows that 26 percent of strike aircraft on five selected strikes were forced to jettison ordnance during period September to December 1966.)

(b) Increasing the requirement for support and CAP/aircraft.

(c) Degrading strike crew effectiveness by adding distraction factors to the already complicated problems of navigation, target acquisition, and ordnance delivery.

g. Armed Reconnaissance

(1) Approximately 90 percent of the attack sorties flown over North Vietnam have been armed reconnaissance missions, however, because of the adverse defense environment, very few of these sorties are flown in RPVI. As flown by the Air Force, these missions generally involve four aircraft during daylight and two aircraft at night while those flown by the Navy are usually conducted by two aircraft at all times.

(2) Day

(a) Flight altitudes for these missions are based on two considerations; the altitude has to be high enough to afford an acceptable degree of protection against automatic weapons and light AAA and the altitude should not be so high as to degrade seriously the pilot's visual target acquisition capability. This normally results in altitudes between 3,000 - 5,000 feet above ground level. In addition, aircraft continually maneuver and vary flight altitudes as further defense against automatic weapons and AAA. During overcast weather, flights remain clear of the base of the overcast whenever possible to deny enemy defenses target altitude information.

(b) Throughout the flight, the trailing section/aircraft maintains a stepped-up two to four miles trail position on the lead section/aircraft. This permits the trailer(s) to

readily position for attack should a target be discovered. If the target is located in a heavily defended area, single-pass attacks using varied run-in headings are employed. If defenses are light or nonexistent, multiple passes are made to increase probability of target destruction. Ordnance utilized on armed reconnaissance missions include bombs, rockets, and 20mm.

(3) Night

(a) Night armed reconnaissance and strike operations against military targets in North Vietnam are conducted primarily by A-4, F-4, and A-6 aircraft. The A-4 and F-4 require visual acquisition and flare illumination of a target for effective attack. The A-6 is an all-weather weapons system that has an effective ordnance delivery capability without dependence on visual reference to the target.

(b) Visual night attack operations are conducted by elements of two aircraft. Visual acquisition of targets is difficult at night and precise navigation is required. Navigation problems of Navy units are alleviated somewhat by utilizing radar-equipped E-2As or E-1Bs to vector strike/reconnaissance aircraft to predetermined coast-in-points. Except during clear moonlit nights, when visual reference to landmarks is possible, overland navigation is conducted utilizing the time-heading-airspeed method. USAF units utilize MSQ-77 ground radar control and inertial NAV or TACAN, where available.

(c) All ordnance except BULLPUP and WALLEYE may be utilized at night. Two weapons configurations of Navy aircraft are used for night operations. Some Navy air wings configure each aircraft with flares and weapons while other configure one aircraft in a section with flares and the other with weapons. On USAF armed reconnaissance aircraft only the lead aircraft is loaded with flares.

(d) Delivery tactics employed at night also differ. Normally, aircraft attack above the flares. However, occasionally where terrain permits, strike aircraft attack beneath the flares utilizing laydown delivery tactics.

(e) Night armed reconnaissance flights are flown at approximately 3500 AGL at 360-420 knots. Trail aircraft fly a three to seven mile trail position on the flight leader depending on unit doctrine. Air-to-air TACAN, radar, and called heading changes are utilized to maintain the desired trail position. The leader, upon spotting a target, notifies the trailer and illuminates the target. The trailing aircraft position for attack and attack immediately upon target illumination. After dropping flares, the leader positions himself for bomb damage assessment and a follow-on attack if one is required.

(f) Efforts have been made to improve the effectiveness of the night armed reconnaissance program by introducing the acquisition/control/attack concept. The acquisition aircraft, either an Army Mohawk equipped with Moving Target Indicator capable side looking radar or an RA-3 equipped with infrared sensors, is employed for initial acquisition of a target. Once a target is acquired, its position is relayed to the control aircraft who vectors the attack aircraft into the area for visual acquisition of the target.

h. Tactical Reconnaissance

(1) Few significant differences exist in the basic concept of tactics of the tactical reconnaissance forces of the 7th FLT and 7th AF. The concepts of mission planning, evasion/masking techniques for transit to and from target areas, and flight maneuvers over the target are similar. Specific differences which do exist are due to different routes/approaches from land/sea bases, terrain and weather encountered, and varying aircraft and reconnaissance sensor capabilities.

(2) Transit, target routing, and flight profiles are flexible; therefore, in most units flight planning is left to the discretion of the reconnaissance aircrews. Flexibility is required due to factors such as day or night missions, types and locations of targets, imagery collection requirements, weather, and the enroute and target defense environments. Evasion tactics are used except during the critical period over the target for proper imagery collection.

(3) Day mission tactics are more flexible due to greater inherent day photo capabilities. Night missions are more critical because of the altitude limitations of night photo cameras, illuminants and infrared sensors.

(4) There are some differences in the way Navy and Air Force units conduct tactical reconnaissance operations.

(a) Escort vs Non-escort. It is 7th FLT policy that tactical reconnaissance aircraft be escorted whenever possible. The purpose of this escort, normally a single fighter, is for Search and Rescue assistance and warning against AAA defense system threat. In the event of a high priority target in a heavily defended area, flak suppression forces may be provided in addition to the normal escort. Under existing 7th AF policy, reconnaissance missions in heavily defended areas are escorted by fighters to provide defensive ECM protection.

(b) Operational Restraints. Currently, 7th AF day photo reconnaissance aircraft are restricted to a minimum flight altitude of 12,000 feet while operating over heavily defended areas of North Vietnam. This policy was implemented due to heavy daytime losses in early January. When weather and/or target priority dictate operations at lower altitudes each requirement is evaluated on an individual basis.

(c) Day Operations. Tactical reconnaissance aircraft employed in North Vietnam have been denied the use of very low and high altitudes by heavy small arms fire, AAA, and the SA-2 missile

threat. As a result, to survive in this environment, reconnaissance must be conducted in the medium altitudes between 10,000 - 15,000 feet. USAF/USN tactical reconnaissance are primarily sensor-equipped to conduct low or high altitude photo reconnaissance and, with the exception of the RF-101, are not optimized to conduct operations in the medium altitude ranges. Both 7th FLT/7th AF recognize this sensor limitation and have forwarded their operational requirements.

(d) Night Operations. The differences between Service capabilities to conduct night tactical reconnaissance is considerable. The RF-4C has the capability to conduct extensive night operations using photographic and infrared sensors. The RA-3B conducts the majority of the Navy night reconnaissance but lacks the performance capability to survive in the high-threat areas. The RA-5C utilizes a strobe illumination system which is ineffective above 1500 feet altitude. In addition, this system exposes the reconnaissance aircraft to visual tracking by AAA. In this respect, extensive use of cartridge illuminants also exposes the RF-4C to the AAA threat.

i. Electronic Warfare

(1) There are few significant differences in the basic service concepts for requirements and utilization of electronic warfare support forces. Two electronic warfare support missions are performed in support of air operations in North Vietnam; passive electronic countermeasures (PECM) and active electronic countermeasures (AECM). These missions are performed by a variety of aircraft and ECM capabilities.

(2) PASSIVE ECM Systems. Tactical ELINT collection of the NVN defense environment is accomplished on a very limited basis. The aircraft deployed to collect ELINT data are used in other roles and/or are capable of providing adequate coverage of North Vietnam to up-date the electronic order of battle

on a timely basis. Therefore, operational planning staffs and aircrews are denied a current and essential knowledge of the NVN electronic order of battle.

(3) Active ECM Systems. The tactics employed by ECM aircraft are generally the same. When more than one strike/reconnaissance force must be supported, the general tactic is to position the jamming support for optimum coverage and maximum protection of the strike forces against threat radars. Where possible, multiple ECM aircraft are employed against a target complex or group of targets using a combination of electronic jamming, chaff, and crossing tracks. The multiple aircraft concept has been determined as the best for maximum degradation of EW/GCI environment; range, azimuth and elevation capabilities of SAM radars; and preventing and/or breaking lock-ons of AAA fire control radars. The effectiveness of ECM in the active role is limited by the number and power of jammers and by inadequate aircraft performance to survive in the high threat areas. Most USAF and USN/USMC ECM aircraft currently employed (E-66B/C, EA-1F, EF-10) are restricted to operations outside the missile envelopes. As a result, USAF EB-66 ECM aircraft are stationed in a cloverleaf orbit 30 to 60 nm from the strike target along the inbound path of the strike forces. When more than one target is supported, the orbit point is positioned or shifted to provide optimum coverage against known threats. Navy ECM aircraft are usually positioned 15-20 miles offshore in an orbit along the route of the strike force. Active support of the strike force commences just prior to coast-in and continues until the strike group has progressed inland to a point where threat radars are directed away from the jamming source by early warning and GCI radars. The effectiveness of stand-off jamming is not directly measurable; however, operational commanders, when queried as to the effectiveness of active ECM, were unanimous in their conviction that stand-off jamming was an essential element in a successful strike operation.

(4) Defensive ECM Systems. As a result of different ECM equipment procured by the services to counter electronic defenses, the tactics

employed by each service are formulated to take full advantage of specific ECM equipment. One major difference in defensive ECM capabilities exists between USAF/USN forces. With the exception of the F-4B, 7th FLTs attack and reconnaissance aircraft are all equipped with defensive ECM (ALQ-51). In contrast, only a limited number of 7th AF attack and reconnaissance aircraft are equipped with the defensive ECM (QRC-160). At the time of the NIGHT SONG field visit the supply of QRC-160 pods was inadequate to equip all tactical fighter/reconnaissance aircraft. The pods available to 7th AF have been allocated to units based upon mission priority. Use of the QRC-160 pods dictates tactics designed to take full advantage of the mutual protection concept. As a result, all aircraft in the flight must fly a rather precise formation to maintain a lateral separation of 1500-2000 feet. Tactics associated with use of ALQ-51 deception repeater differ in that each aircraft has individual protection thus offering more flexibility in formulating tactics.

j. Search and Rescue (SAR)

(1) The Commander 7th AF is responsible for SAR coordination in the Southeast Asia area of operations and exercises operational control of all USAF SAR forces. CTF-77 exercises operational control of USN SAR forces. (See Appendix G).

(2) USN SAR forces are comprised primarily of UH-2A/B and SH-3 helos, A-1 RESCAP and two DD/DLGs located at northern and southern SAR stations. Navy rescue operations are conducted mainly in the Tonkin Gulf and coastal areas of North Vietnam.

(3) USAF SAR forces are comprised of HH-3E and HH-43B/F helos, HU-16, HC-130P, and A-1 RESCAP aircraft. USAF SAR operations are conducted over all land areas, plus HU-16 support in the Tonkin Gulf.

(4) Navv Operating Procedures

(a) One UH-2A/B helo is embarked in each SAR DD/DLG. These helicopters are armed, equipped with self-sealing fuel cells and armor plate and are on alert status 24 hours a day.

(b) Embarked on one of the three YANKEE STATION CVAs, is a three plane SH-3A helicopter detachment. The SH-3A is armed, equipped with self-sealing tanks and armor plate and is the primary rescue vehicle used over North Vietnam. One SH-3A is airborne at all times during daylight hours escorted by A-1 RESCAP. During hours of darkness, both the SH-3A and A-1s are held in a ready alert status aboard the CVA.

(5) USAF Operating Procedures. SAR support aircraft are normally airborne whenever air operations are being conducted over North Vietnam. Predesignated orbit areas are established for the HC-130Ps and HU-16s over Laos and the Gulf of Tonkin, these areas being dictated by target location. The HH-3Es normally stage into advanced operating bases in Laos and are committed to five minute ground alert or to airborne alert in permissive areas. In addition to the normal rescue vehicles, RESCAP aircraft (A-1Es) are placed on alert status at Udorn.

(6) When an aircraft is shot down, the initial SAR effort is normally accomplished by the accompanying strike/CAP aircraft, and consists of locating the downed airman and directing SAR forces to the rescue area. Upon notification, the SAR alert forces are scrambled, if not already airborne, and proceed to the rescue area. The senior on-scene pilot normally acts as airborne coordinator for the rescue effort and coordinates with ground station/YT Commander for additional support if an extensive search is required.

(7) The success of the rescue effort is dependent, to a large degree, on the intensity of the enemy defenses and the proximity to population centers. Although RESCAP and escort aircraft carrying ordnance are usually available to suppress groundfire,

the size and slow speed of the rescue aircraft, along with the inherent requirement for low and slow flight, make the rescue aircraft vulnerable to enemy fire. Rescue efforts are virtually prohibited in the heavily defended and densely populated areas of Route Package VI.

(8) SAR operations have been degraded by the following equipment and environmental factors:

(a) The limited range and endurance of present rescue vehicles (HH-3/SH-3) restricts the area which can be covered.

(b) The slow speed of the rescue helicopters results in excessive reaction time from notification to pickup which reduces probability of recovery.

(c) Available helos are vulnerable to enemy groundfire due to the low altitude and slow speed nature of operations. The requirement to hover for pickup increases the hazard.

(d) Night recovery capability is limited due to difficulty in:

1. Low level navigation and terrain avoidance.

2. Locating downed airmen during hours of darkness.

(9) Future SAR operations will be enhanced through better self-protection, extended range, and higher speed for the helicopter. Three M-60 miniguns are being installed in all HH-3Es. The HH-53B, with 50 knot higher airspeed and self-protection armament will be added to the inventory in early FY 68. Both HH-3Es and HH-53Bs will be capable of air refueling from the HC-130P.

(10) Development programs are underway to adapt LLLTV and/or FLIR sensors to rescue vehicles to improve the night rescue capability.

~~SECRET~~

(11) A need exists for a high-speed armed VTOL aircraft with sufficient range, endurance, and payload capacity to effectively accomplish the SAR mission in a sophisticated defense environment.

~~SECRET~~

F-16

Appendix F

ANNEX A TO APPENDIX F

FUTURE TACTICS

TACTICS FOR FY 68/FY 69 AND SUBSEQUENT

1. (S) The tactics currently employed by USN/UCAF units in North Vietnam, although developed separately, are basically the same with the exception of minor differences. These tactics are considered near optimum for the current NVN air defense environment, available equipment/munitions, and constraints. This is not to say that tactics are static, for they are sensitive to changes in the air defense environment and to the introduction of new capabilities of equipments and weapons. A listing of new or modified equipment expected to be available in FY 68/FY 69 and subsequent periods, appears at Appendix E. Those which are expected to have the greatest impact on operations in the NVN air defense environment are:

<u>FY 68</u>	<u>FY 69 & Subsequent</u>
<u>ECM Equipment</u>	<u>ECM Equipment</u>
Compass Strike (TOA)	EELS (TOA)
ALQ-51 Mod II	TRISAT
ALQ-100	
ALQ-71	
IFF (TEASER)	
ALQ-76	
ALT-27	
Expendable Jammers (QRC 297)	

FY 68

FY 69 & Subsequent

Aircraft

A-7A

F-4J

F-4D

EKA-3B

Munitions

WALLEYE

TALOS ARM

CBU-24/29

Proximity Fuze

Standard Arm (Mod O)

Aircraft

F-111A

F-4E

A-7D

Munitions

AIM-4

AIM-7F

Standard Arm (Mod 1)

Anti-vehicle land mines
(AVLM)

Sensors

Forward Looking Infrared
(FLIR)

Low Light Level TV (LLTV)

2. (S) The new or improved equipments which will be available during the above time frames should provide:

a. Better self-protection against radar directed defenses (ALQ-51, ALQ-100, ALQ-71).

b. Greater stand-off capability against certain targets with WALLEYE. The accuracy of this weapon can also permit attacks on targets considered too close to populated areas, neutral shipping, etc., for weapons with greater CEPs. Standard ARM will provide longer range and greater lethality against radiating S-band radars than does SHRIKE.

c. Better accuracy in locating electronic emitters by use of TOA principle in COMPASS STRIKE/EELS aircraft.

d. More effective and larger numbers of radar/communications jammers.

e. Increased quantities of CBU-14 and proximity bomb fuzes will afford better AAA/automatic weapon suppression and SAM site kill probability.

f. More effective weapons systems to counter the MIG threat (improved aircraft, missiles, and electronics).

3. (S) From the foregoing it would appear that the approaches which promise greatest returns are those which will enable strike forces to operate in the SA-2 envelope and above the effective range of light AAA and automatic weapons. Actions considered necessary to effect the above:

a. Locate and destroy or nullify the SAM threat in North Vietnam.

b. Jam/Deceive HF communication links.

c. Install self-protection devices in individual aircraft.

d. Increase use and improve equipment of passive and active ECM support aircraft.

e. Provide continuous intelligence surveillance of the NVN air defense system.

4. (S) SAM Destruction. Destruction or nullification of the SA-2 in North Vietnam would increase the effectiveness of strike forces and in addition lower attrition rates by permitting strike aircraft to remain for the most part above the AAA defenses.

a. Heretofore, destruction of SAM batteries, particularly mobile units, has been difficult due to the inherent inaccuracy of ELINT fixes (1-10 miles). This accuracy has not been sufficient in most instances to enable pilots to visually acquire the target. Introduction of a Time of Arrival (TOA) system (Compass Strike/EELS) should afford an accurate, real time capability to locate S-band radars, including FAN SONG, within a 900 foot circle.

b. Accurately locating the SAM radar solves only one part of the SAM suppression/destruction problem.

The site must still be attacked by strike aircraft employing missiles or bombs.

c. Since tactical aircraft will not be capable of pinpoint navigation during initial deployment of TOA, feasible methods of attacking SAM radars located by TOA are:

(1) Attack with SHRIKE/INTERIM ARM to suppress SAM, or by use of white phosphorus (WP) warhead, visually mark site for other strike aircraft.

(2) Use of ground controlled radar (MSQ-77) or airborne control radar (E-2A) to vector strike aircraft to SAM site. If site is visually acquired conduct attack.

(3) Photo reconnaissance would be conducted to pinpoint sites which could not be visually acquired.

(4) Attack with area weapons those sites which have been located by TOA and cannot be acquired visually.

(5) Use of TALOS ARM.

5. (S) SAM Nullification. Track information from the NVN FIRECAN and the early warning/GCI net has enabled the SAM system to employ emission control (EMCON) procedures effectively. EMCON has made detection of the SA-2 more difficult. Critical elements in the GCI/EW net appear to be the early warning radars and communication links. ELINT information obtained by BRIGAND has an impact accuracy of about one-tenth mile. Some 26 percent of the EW/GCI radars have been so located. Correlation of this data by photography would identify those sites which could be attacked under current constraints. Jamming of defense radars and disruption of the communication links between GCI/EW network appears to be possible by making a concerted effort with new ECM equipment scheduled for deployment to the theater. Loss of tracking information from this net would most likely degrade EMCON capability and require that the SAM acquisition radar be utilized to a greater extent.

~~SECRET~~

c. (3) Degradation or Nullification of AAA Radars. Numerous reports indicate that the use of ECM against NVN fire control radars has been successful, and has contributed to a noticeable decrease in losses due to flak. Comments from strike aircrews indicate that radar directed AAA is sporadic and inaccurate when ECM aircraft are supporting a mission. In a non-ECM environment, radar controlled AAA is normally heavy and accurate. Experience has proven that it is considerably easier to prevent fire control radars from acquiring a lock-on than to break-lock once obtained. Break-locks can be effected by using active ECM equipment and chaff bursts.

a. PACAF has reported that QRC-160 test missions were flown over heavily defended target areas which contained S-band radar controlled 85mm and 100mm (AAA) and SAMs. Nineteen four-aircraft combat missions were flown with QRC-160A-1 pod equipped F-105s. At no time during the test phase were any jamming aircraft in formation tracked and fired upon by radar directed AAA or SAMs. During these missions EB-66C crews collected data on the reaction of enemy radars to the pod jammers. AAA was observed on two occasions; once over the Red River close to Yen Bay and once a few miles north of Hanoi. The AAA in the Yen Bay area was of the barrage type and consisted of 37mm non-radar controlled fire only. Only one SAM firing was reported and this was directed at a non-jamming aircraft in distress. During the first 16 of the 19 test missions flown over North Vietnam there were no reported sightings of radar controlled AAA or SAMs. Radar activity in the test target areas varied from moderate to very dense signal activity* The NIGHT SONG field visit revealed that all operational units believe the introduction of the QRC-160 has seriously degraded the SA-2 and radar directed AAA elements of the enemy defense environment. Aircrews are confident of their ability to survive in the NVN defense environment.

b. ALQ-51. Pilot interviews conducted during the Study Group's field trip indicated high pilot confidence in the equipment. Tests have shown that the ALQ-51 degrades effectiveness of AAA fire control

PACAF Tactics and Techniques Bulletin #54 of 6 January 1967

~~SECRET~~

FA-5

Annex A to
Appendix F

radars (FCR) by a factor of about three if the best operators employ manual tracking, and further degradation was experienced when automatic tracking was attempted. CINCPACFLT analysis states that the ALQ-51 has probably reduced direct losses to SAMs among strike aircraft so equipped by a factor of five. In addition, the ALQ-51 has probably contributed to a reduction in SAM-associated losses because of less need for evasion and penetration into the AAA envelope.*

7. (S) Flak Suppression. It was previously noted that lack of suitable weapons in quantity has limited flak suppression in North Vietnam. Use of suppressors has increased with the introduction of CBU-24, larger proximity fuze bombs and proximity fuze AGM-12C. These weapons in their present configuration are not considered optimum for the task, and improved weapons/delivery systems are required.

a. CBU-24. The canister is currently fuze with a mechanical time-delay fuze (M907) which is pre-set before takeoff. This requires precise dive angle, airspeed, and release altitude in order to achieve the optimum ground pattern (which is a function of burst height). The pilot has limited flexibility in the choice of his method of delivery. Installation of a proximity fuze (such as the FMU-56/B now under development) will provide a broad choice of attack modes, speeds, and altitudes as may be dictated in the target area by such factors as weather, terrain, shifting defenses and targets of opportunity.

b. The BLU-26 bomblet currently used in the CBU-24 is impact fuze. Although the bomblet pattern and lethal radius provide a good Pk for exposed troops and light equipment, including those in open revetments such as AAA sites, the suppression effect is limited to the time of impact. Simple defensive measures such as foxholes or sandbags for personnel cover provide protection except for a direct hit.

* CINCPACFLT 080221Z January 1967

Production of proximity (advanced BLU-26/B) and delay (BLU-36/B) fuzeed bomblets would provide the capability of a mixture of fuze options for each canister. It would increase the kill probability against lightly protected troops (proximity feature) and extend the time of suppression (delay feature).

c. Simple protective measures, such as sheet metal roofs or elevated wire mesh covers over aircraft revetments could provide adequate protection against BLU-26 type weapons. Similar protective coverings could also be used for radar vans and antennas, gun and missile positions, and other facilities which would otherwise be vulnerable to the bomblets. Consideration should be given to accelerated development of bomblets such as the MK-118 antitank bomb used in ROCKEYE II, which has the capability of armor piercing or fragmentation effects.

8. (S) Anti-MIG Tactics. The introduction of new US equipments and improved coordination/control procedures should enhance our capability to maintain superiority over the NVN MIG forces. Increased US capability will be countered, to a degree, by the enemy's advances in aircrew proficiency, aircraft inventory, command/control procedures, and aircraft and support system maintenance. A discussion of anti-MIG tactics should include consideration of actions against supporting facilities (MIG bases and EW/GCI net) as well as air-to-air alternatives. Current rules of engagement and other operational restraints limit the degree to which an all-out campaign against MIGs can be conducted. The political necessity of these restraints as they relate to our national policy, should be carefully weighed against the military advantages which would accrue if they were partially or completely removed.

a. Attack the Airfields. There is complete agreement, from a military standpoint, that destruction of the enemy air forces on the ground--that is attacking jet-capable airfields, is the most effective method of reducing the MIG threat. The initial weight of effort for such an enterprise would be relatively massive due to the deployment of the MIGs among the enemy airfields; but the cost, in terms of pilot and

aircraft losses, would not be prohibitive according to current estimates (see SEACAL III Report). A large number of the enemy aircraft would probably be destroyed, depending upon the timing of the attack and the degree of surprise achieved. Periodic restrikes would deny the use of the airfields for future air action.

b. Attack the EW/GCI System

(1) The NVN EW/GCI net provides radar warning and control throughout the country. They have demonstrated a capability to effectively control their interceptors in a defense environment including heavy AAA and SA-2s. Loss of their radar network would significantly impair enemy air-to-air operations. It would restrict their operations to areas outside of the high value target areas, due to the necessity of avoiding their own AAA and SAM defenses; and would cause them to rely upon airborne radar or visual tactics for their engagements. This would place them at a disadvantage in view of the superior radar intercept equipment of our fighters.

(2) The technical limitation to our capability to destroy radars is the problem of detection and location. Implementation of Time of Arrival (QRC-334) will improve the situation at least against S-band radars. The number of EW/GCI radars and their dispersion throughout North Vietnam prohibit an all-out attack effort against them until multifrequency TOA capability exists. Regardless of technical capability, the primary limitations of the effective all-out campaign are the restraints against strikes in the Hanoi/Haiphong area. The heart of the NVN Command/Control System is located there or else on airfields which are also protected from attack. Even if we were capable of destroying all EW/GCI radars outside of the sanctuaries the enemy could still maintain effective control from protected sites. Measures which would tend to degrade the EW/GCI systems are:

(a) Use of increased force of EB-66B (BROWN CRADLE)/EKA-3B(TACOS) aircraft would enhance the survivability of strike aircraft. The increased number of active ECM systems would provide concentrated jamming from multiple directions.

(b) Use of deceptive measures such as chaff or decoys to increase the number of tracks, which would complicate identification and saturate their communication system.

(c) Employ communications jammers against HF and VHF communications systems to inhibit their cross-tell and aircraft control capability.

c. Air to Air Operations

(1) In the present defense environment over North Vietnam the enemy has been able to "call the shots" on committing his interceptors. MIGs are normally airborne whenever our forces are within their area of operation, but they are not usually committed unless they have a position of advantage or it has become obvious that our strike force is attacking the high-value targets in and around Hanoi or Haiphong. On occasion, the MIGs appear to be content to deter the strike aircraft from hitting the target by causing them to jettison their ordnance, and will only press the attack if they have position advantage. Recently MIG-21s have been encountered in and around heavily defended AAA and SAM areas, and on occasion have attempted to lure our fighters into "flak traps."

(2) The concept of employing CAP aircraft to screen the strike forces from the potential air-to-air threat has been effective. The F-4 has proven to be superior to the MIG-21 at low altitude; and on the few occasions where, through deceptive tactics we have been able to catch the MIG at a disadvantage, e.g., the fighter sweeps by F-4Cs in early January 1967, the results have been rewarding.

(3) Air-to-air detection capability will be improved with the introduction of the F-4D/F-4J aircraft. The F-4J will have an AI radar with look-down capability. The AIM-4 (F-4D) and AIM-7F (F-4J) will improve our effectiveness in air-to-air engagements through increased accuracy and maneuverability of the missiles. The F-4E, with its internally mounted gun, will enhance future air-to-air effectiveness. Air-to-air identification systems TEASER/TRISAT will be available and will afford positive identification of enemy aircraft.

(4) Another area which appears to offer improvement in the United States/MIG kill ratio is the fusion of all available intelligence data and the timely dissemination of these data to tactical forces. Positive radar tracking and control of all friendly aircraft, in conjunction with secure ground-to-air and air-to-air communications, would provide maximum exploitation of intelligence inputs.

9. (S) Interdiction of NVN LOCs

a. Interdiction of lines of communication (LOC) represents over 90 percent of the air effort conducted to date against North Vietnam. This interdiction effort has been directed against a variety of targets including roads, railroads, waterways, transshipment points, truck parks, rail yards, storage areas and distribution points. The program has included the destruction of bridges, catering of roads and railroads, road/railway/waterway reconnaissance, and seeding of LOCs with time-delay fuzed bombs as a means of degrading the enemy's ability to move supplies. However, the North Vietnamese have proven themselves to be very proficient in countering these efforts. Only in the case of the rail network in Southern North Vietnam has the interdiction effort approached a desired level of success. The repair of rail lines and construction of railroad bypasses are more time consuming than highway repairs. The use of seeder bombs, designed to inhibit repair activities and harrass traffic, has not achieved the planned

~~SECRET~~

results. The fuzes available for these bombs do not have anti-disturbance features, and the enemy has been successful in moving them to safe areas where detonation will not disrupt their LOCs.

b. The interior LOCs most vital to the maintenance of the NVN war effort are the northwest and northeast routes between Hanoi and China, and the routes that connect Haiphong with Hanoi and Nam Dinh. These LOCs are located in the most heavily defended areas of North Vietnam. A concentrated interdiction program has not been directed against them, primarily due to aircraft attrition considerations and the need to simultaneously close the ports. The majority of the efforts have been in the form of strikes on fixed targets (bridges, rail yards, etc.). The result of this effort, in terms of degrading the enemy's air defense capabilities, has been limited in view of the continued proliferation of the defenses. With the exception of the WALLEYE no new weapons and weapon systems will be available to the operating forces within the next several months which will increase the effectiveness of the interdiction program. The WALLEYE, with a predicted CEP in the neighborhood of 10 feet, should afford improved kill probabilities against certain fixed targets such as bridges.

c. Weapons and weapon systems that will become available between July 1968 and July 1970 that will increase our interdiction effectiveness are the A-7 and F-111A aircraft, the MSQ-77, and aerial-delivered mines:

(1) A-7. The primary contribution of this aircraft lies in its greater ordnance-carrying capability. Its ability to deliver a given amount of ordnance against a target utilizing fewer aircraft decreases crew/aircraft exposure to the enemy air defense system. The aircraft is equipped with a computing bomb release system designed to increase delivery accuracy and thereby increase target destruction probability.

(2) All-Weather Interdiction (A-6/F-111A/MSQ-77). The A-6 is the only aircraft now in Southeast Asia which has a true all-weather capability. The F-111/

~~SECRET~~

FA-11

Annex A
Appendix F

MK-II weapons system should provide the Air Force with a radar bombing capability. Installation of the MSQ-77 site in northern Laos will extend its coverage to virtually all of North Vietnam. It could be used in some areas under all conditions, day and night, and in missile defended areas during daylight hours when an undercast cloud cover obscures the target.

(3) Aerial-Delivered Mines. The objective of an interdiction campaign is to prevent or restrict enemy logistic movements. Although complete denial of the use of the LOCs is, for all practical purposes, unattainable against a determined adversary, this goal can be approached by delaying his movements and increasing the amount of time needed to move a given amount of material a given distance. The campaign to restrict the movement of supplies within North Vietnam and to South Vietnam has been conducted by day and night armed reconnaissance, developing choke points by cratering roads and railways and destroying bridges. The armed reconnaissance program has reduced the enemy's movement during daylight hours in the areas in North Vietnam where his air defense posture permits continuous armed reconnaissance. In these areas he is forced to move under the cover of darkness, and a choke point program has been developed to counter this night movement. This tactic has not been completely successful, in that choke points have quite often been by-passed or quickly repaired and movement of supplies continued.

(a) A weapon that has yet to be employed in the choke point program is the aerial-delivered mine. The use of these mines as a means of developing choke points appears to have merit and offers the following advantages:

1. Provides the option of determining where the choke point will be established. Effective choke points developed in undefended areas preclude, to some degree, attacking heavily defended interdiction targets such as bridges.

2. In addition to casualties inflicted by the mines, the field would serve to back up and channelize traffic and fix the enemy as a target for destruction by other weapons.

3. If breaching time is of long enough duration (12 to 15 hours), and the mine fields are laid at sunset, enemy night movement will be halted along the mined LOC. Breaching time can be increased by using self-burying mines which compound the enemy's detection problems. Detectability, particularly visual, is a vital consideration for quick and sure detection countermeasures. Seeding with mixed loads, mines that require different sweeping methods, aggravates the enemy's clearing problems and further increases delay time. Built-in delays are represented by the time spent in transporting trained mine clearance personnel to the area, and in communicating and decision-making.

(b) A weapon presently under development that incorporates the desired characteristics to meet tactical mining requirements is the aerial-delivered anti-vehicle land mine (AVLM). This is a self-burying, blunt-nosed bomb-type munition weighing approximately 19 pounds. Thirty AVLM can be carried in each Tactical Fighter Dispenser Munitions (TFDM). The mine is influence-fuzed and senses rate change in the earth's magnetic field resulting from the passage of a vehicle. Rotation in the earth's magnetic field, associated with clearing, will also cause detonation and serves as a anti-disturbance feature for the AVLM. The AVLM/TFDM configuration is primarily designed for level flight delivery from relatively low altitude. Although this delivery mode is satisfactory in lightly defended areas, it is not desirable in high threat areas such as the LOCs in RP V and VI. Consideration should be given to developing tactics/hardware capability for the TFDM or an AVLM cluster similar to the

CBU-24 which would allow accurate dive and high-altitude delivery.

(c) The tactical advantages offered by the use of aerial-delivered area denial weapons would increase the flexibility of interdiction operations, improve aircraft survivability, and add to the delay and cost of the enemy's movement of material.

10. (S) Weapons. A study of the weapons in inventory and/or development at this time indicates shortcomings in our weapons development philosophy. Although a broad spectrum of demolition and general purpose bombs are available or being developed, area coverage or dispenser-type munitions are, with the exception of CBU-24/29, limited to low altitude level flight delivery modes. The nature of tactical air operations demands flexibility and selectivity of delivery techniques and weapons effects. Aircraft survivability is also a consideration. The losses experienced at low altitudes in North Vietnam dictate a requirement for weapons which can be delivered from a dive or medium altitude level flight as well as from low level. Some design parameters for development of these weapons are considered to be:

a. Weapons/explosives which afford improved air-speed limitations, munitions payload, and destructive power with decreased munition weight and size.

b. Area denial capability.

c. Cockpit selectivity of fuzing and low or high drag delivery mode.

d. Dive delivery capability with acceptable accuracies for all dispenser munitions.

11. (S) Tactical Reconnaissance

a. Basic tactics by both services should not change appreciably in FY 68 since no new tactical reconnaissance aircraft or sensors will be introduced in Southeast Asia. The installation of the ALQ-51 internally in the RF-101 and the modification

of the RF-4C to carry the QRC-160A-1, external pod mounted jammer, will enhance the survivability of USAF tactical reconnaissance aircraft. With this equipment fighter escort requirements may be reduced except for those missions in very high threat areas.

b. As defensive ECM equipment becomes available in CY 67, penetration and withdrawal altitudes for USAF aircraft can be raised above the most effective altitudes for small arms and light AAA. However, penetration and withdrawal routes will continue to be planned to avoid direct flight over heavily defended areas.

c. The modification of the RF-4C ALR-17 (ELRAC) system in FY 68 will improve the capability of this system to locate and record location of pulse radars by marrying the ALR-17 to camera systems other than the KA-56. The ALR-17 superimposes the approximate location of pulse radars on film utilizing the binary data annotation system (BDAS). Current tactics dictate the use of medium/high altitude camera systems. This modification will provide a capability for automatic detection of pulse radars at other than low altitudes.

d. Navy reconnaissance aircraft are already ALQ-51 equipped. Improvements in this equipment (ALQ-51 Mod II) should improve survivability. Improved sensors, such as IR, SLR, and intermediate altitude cameras, will result in increased capability. A successor to the RF-8 aircraft for MIDWAY class CVAs is required. The RF-4B would be a suitable replacement.

12. (S) Use of Current Capabilities. Seventh Air Force/CTF-77 now have unique capabilities which for valid reasons have not been extensively utilized to exert pressures on the NVN Air Defense System. Development of and experimentation with the following measures would increase pressure on the air defense system. In addition, they could provide the basis for future decisions regarding an air defense campaign.

a. Intelligence sources have identified and confirmed by photography the location of 28.5 percent

of the NVN EW/GCI associated radars within accuracies of one-tenth of a mile. A total of 43.5 percent of these radars have been located within one mile or less through ELINT and other sensor capabilities. These fixes could be fused with other existing intelligence to enable quick reaction forces to attack or harass the enemy radar installations.

b. Information obtained by BIG LOOK, BIG EYE, COMMANDO LANCE, and PIRAZ sources could be utilized to harass and destroy MIG aircraft on training and combat flights on a scale not realized to date.

c. WILD WEASEL/IRON HAND forces could be more extensively employed for hunt and destroy SAM missions in a random manner consistent with availability of these forces.

d. Coordinated use of USN/USAF stand-off jammers could be employed to harass/degrade surveillance radars and communications links.

~~SECRET~~

APPENDIX G

COORDINATION AND CONTROL

1. (S) General

a. Coordination and control functions pertaining to the US air Campaign against North Vietnam are presented herein. The authority, philosophy, control, coordination and conduct of unilateral and bilateral USN/USAF/USMC air operations in North Vietnam are outlined. Operational concepts are described followed by a discussion of procedures and supporting systems/elements in use by COM 7th FLT, CMDR 7th AF, and CG, III Marine Amphibious Force (MAF), in the conduct of air operations. Presentation is keyed sequentially to mission execution from authorization through post mission analysis with an attendant discussion of the supporting roles of intelligence and communications.

b. CINCPAC has operational control of all US forces in the Pacific area. He exercises the operational control of forces through service component commanders, CINCPACFLT, CINCUSARPAC, AND CINCPACAF and through subordinate unified commanders, COMUSMACV and COMUSMACTHAI.

c. The geographical area of operations in Southeast Asia includes South Vietnam, Thailand, North Vietnam, Laos, and the adjacent waters of the Gulf of Tonkin. The land area within North Vietnam has been subdivided into seven operating areas called Route Packages (RPs). These packages are numbered I through VI with VI further subdivided into two areas designated VIA and VIB.

d. Coordination Authority for US air operations in Southeast Asia has been delegated by CINCPAC to COMUSMACV for operations in South Vietnam, Laos, and the southern part of North Vietnam (RP I), to CINCPACAF for operations in RPs V and VIA and to CINCPACFLT for operations in RPs II, III, IV, and VIB. The forces operate in an integrated and coordinated effort toward a common goal. Provision has been made

~~SECRET~~

~~SECRET~~

for coordinated operations in any area on a planned basis or on a divert or emergency basis.

e. CINCPACAF has delegated his authority to the CMDR 7th AF. CINCPACFLT has delegated his authority to COM 7th FLT and in turn to CTF-77. Consequently, CMDR 7th AF, as a subordinate commander to CINCPACAF and as the Air Force component commander to COMUSMACV, has Coordinating Authority for all US air operations in the Mainland Southeast Asia region, except for RPs II, III, IV, and VIB of North Vietnam, for which CTF-77 has Coordinating Authority.

f. Military directives to CINCPAC to conduct air operations originate with the Joint Chiefs of Staff. The ROLLING THUNDER execute messages include directives to strike designated targets (Alpha targets) and authorizations to continue other types of offensive air operations subject to certain well defined constraints.

g. Upon receipt of Joint Chiefs of Staff directives, CINCPAC assigns specific targets (Alpha targets) to the Navy or Air Force Component Commanders. Geographical areas of responsibility, as described in c. and d. above, are assigned to each of the component commanders and to COMUSMACV for the conduct of additional offensive operations. Navy, Air Force, and in certain areas, Marine Corps commanders, are authorized to plan and conduct certain types of air operations in North Vietnam and adjacent waters of the Gulf of Tonkin on a continuous basis. Essentially, this continuous program consists of offensive and combat support air operations.

h. A primary objective of the offensive air program is to impede the flow of men, equipment, and material to the Viet Cong and NVN forces in South Vietnam. Included in this program is air interdiction of lines of communication (LCC); road, rail, and water. It also includes authorization to strike all fixed military targets associated with the logistics support and movement of men, equipment, and material that have not been specifically excluded from air attack. Combat support operations include photo/IR/SLAR recce, ECM, ELINT, various combat air patrol (CAP), tankers, airborne command platforms, and radio relay aircraft.

~~SECRET~~

~~SECRET~~

i. Procedures for coordination of friendly air operations in Southeast Asia between CDR 7th AF and CTF-77, is covered in an operational procedural agreement. The CDR 7th AF/CTF-77 Coordinating Committee performs a continuing function in this area. (See Tab A, Annex E for Memorandum of Operational Procedural Agreement between CDR 7th AF/CTF-77).

j. The Commanding General, First Marine Air Wing (CG FMAW) is the Marine Air Commander for CG III MAF. A procedural agreement for coordination of air operations in RP I has been agreed upon by CDR 7th AF and CG FMAW.

~~SECRET~~

~~SECRET~~

ANNEX A TO APPENDIX G
US NAVY OPERATIONS

1. (13) Navy Procedures For Control and Coordination of Air Operations in North Vietnam

a. Types and Areas of Operations

(1) Operations conducted by TF-77 in Southeast Asia are directed by COM 7th FLT and higher authority. Principally, these operations comprise air strike and supporting operations against North Vietnam and air strike and supporting operations in support of COMUSMACV.

(2) Naval gunfire operations conducted by TF-77 forces in North Vietnam. (SEA DRAGON)

(3) This study is limited to those operations conducted against North Vietnam. Direction and guidance for the conduct of these operations is provided via the operational chain of command depicted in TAB A.

b. Organization and Functions

(1) Command Relationships

(a) COM 7th FLT - provides forces for conduct of Naval air and surface operations in Southeast Asia, other than forces assigned COMNAVFORV, and exercises general direction of such operations as a principal subordinate of CINCPACFLT.

(b) Commander Attack Carrier Striking Force 7th FLT/CTF-77 exercises over-all direction of TF-77 forces. He is responsible for long range planning, direction and coordination of operations.

(c) The YANKEE TEAM Commander (CTG-77.0), a designated Carrier Task Group Commander (CTG) of TF-77, assumes operational control and exercises day-to-day direction of TF-77 forces that are

~~SECRET~~

GA-1

Annex A to
Appendix G

assigned by COM 7th FLT. Although subordinate to CTF-77, CTG-77.0, in his role as YANKEE TEAM Commander, is authorized to communicate directly with CINCPACFLT, COM 7th FLT, COMUSMACV and CMDR 7th AF concerning operational or administrative matters as previously established and regularly required. Otherwise, standard command relationships apply. Designation as CTG-77.0 is made on a rotational basis to a Carrier Division Commander currently at YANKEE STATION.

(d) Carrier Task Group Commanders of single Carrier Task Groups within TF-77 (numbered CTG-77.2 through CTG-77.8) are responsible for the conduct of air operations by the assigned carrier and supporting ships under the direction and guidance of CTG 77.0 and higher authority.

(e) Coordination with COMUSMACV and subordinate commanders, especially CMDR 7th AF, is provided through the 7th FLT Mobile Air Coordination Team CTU-70.2.1, principally the element at Saigon, CTE-70.2.1.1. (Navy Liaison Officer (NLO)).

c. Identification of Functions Involved in Conduct of Air Operations Against North Vietnam

(1) Offensive Combat Missions

(a) Strike/armed reconnaissance (recce) missions by fighter or attack aircraft with air-to-ground weapons in support of ROLLING THUNDER objectives.

(b) Flak suppression missions by fighter or attack aircraft with air-to-ground weapons against defending AW or AAA sites in support of strike/armed recce missions.

(c) IRON HAND missions by attack aircraft with specialized air-to-ground weapons directed against enemy SAM sites. These missions may be tasked independently or in support of strike, armed recce or photo recce missions.

TAB A TO ANNEX A TO REF ID: A66161

COMMAND RELATIONSHIPS (NAVY)

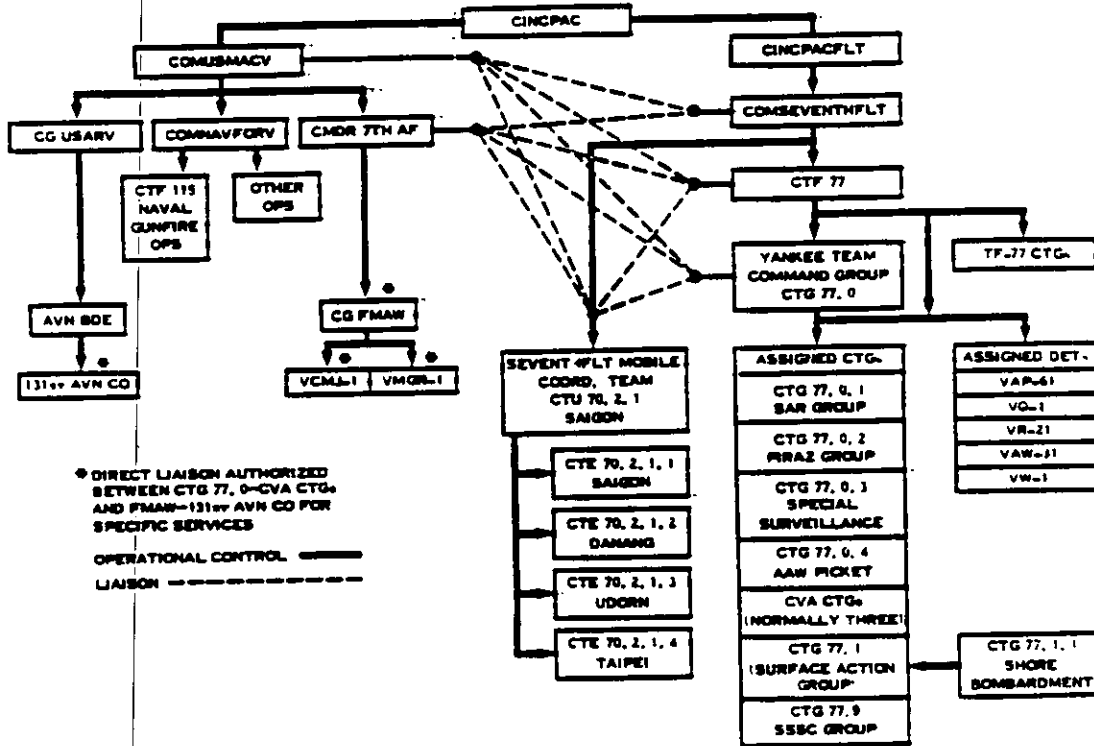

(d) Target Combat Air Patrol (TARCAP) missions by fighter aircraft with air-to-air weapons for operations against enemy aircraft either as a separate mission or in support of strike, armed recce or photo recce missions.

(2) Defensive Combat Missions

(a) Barrier Combat Air Patrol (BARCAP) missions by fighter aircraft with air-to-air weapons for intercept of enemy aircraft threatening support aircraft.

(b) Force Combat Air Patrol (FORCECAP) missions by fighter aircraft with air-to-air weapons for intercept of enemy aircraft threatening the Task Force and to augment BARCAP as required.

(c) Rescue Combat Air Patrol (RESCAP) missions by attack aircraft with air-to-ground weapons to support aircraft and helicopters conducting rescue operations, to suppress enemy fire in the rescue area, and to disperse enemy forces attempting to interfere with rescue operations.

(3) Combat Support Missions

(a) Airborne Early Warning (AEW)/Air Control missions by E-1B/E-2A and occasionally EC-121M aircraft. These aircraft are equipped with radar and communications equipment to provide radar early warning of enemy aircraft and advisory air control of CAP aircraft (principally BARCAP and FORCECAP). The E-1B/E-2A are also used for coordination and control of US supporting air operations.

(b) MIDDLEMAN service (relay of UHF communications between tactical aircraft and ships) is provided by E-1B, E-2A and A-3B (Tanker) aircraft as directed for specific operations. MIDDLEMAN service is scheduled in conjunction with other missions.

(c) Photographic-reconnaissance missions by RA-5C, RF-8A and RA-3B aircraft in support of

BLUE TREE objectives. Post strike Bomb Damage Assessment (BDA) missions are included in the BLUE TREE program and are normally performed by RA-5C and RF-8A aircraft.

(d) Electronics Countermeasures (ECM) jamming missions by EA-1F, EA-3B, and Marine EF-10B/EA-6A aircraft. These aircraft have the capability of providing enemy surface-to-air missile (SAM) activity and firing warnings, and also contribute information to the SAM and Electronic Order of Battle. A-3B aircraft are being modified to EKA-3B configuration (Code name TACOS) as replacements for EA-1F aircraft and to provide ECM jamming, SAM warnings and a tanker capability.

(e) Electronics Intelligence (ELINT) missions by EC-121M (BIG LOOK), EA-3B and RA-5C aircraft. BIG LOOK and EA-3B aircraft have a dual mission of SAM warning. BIG LOOK has an alternate capability for MIG warning. In BIG LOOK the MIG warning capability is additional to ELINT collection and cannot be done simultaneously with MIG warnings. Therefore, emphasis is placed on ELINT collection and SAM warnings. (See TAB B). The ELINT/photo capability of the RA-5C is not simultaneous. The aircraft can carry the equipment for one mission or the other and must be configured prior to the mission.

(f) Tactical warnings, other than those based on visual observation, are provided to aircraft from the following sources.

1. MIG warnings - E-1B/E-2A AEW aircraft, BIG LOOK (as directed), surface radars (principally the PIRAZ ship and SAR destroyer), 7th AF air control aircraft (BIG EYE) and other sources through MOTEL (7th AF TACC (NS)).

2. SAM warnings - BIG LOOK, COMMANDO LANCE aircraft and MOTEL are the primary sources of general area warnings on SAMs; the RB-66, EA-1F and USMC EF-10B/EA-6A also can detect SAM emissions and transmit self defense warnings.

3. CHICOM Border/Buffer Zone warnings - BIG EYE, PIRAZ, COMMANDO LANCE, Anti-Air Warfare Coordinator (AAWC) (normally CIG 77.0 in a CVA), or MOTEL. The PIRAZ, MOTEL or AAWC warnings may be based on information derived from other sensors and sources.

(g) In-flight refueling missions by A-3B tanker configured aircraft or Marine KC-130 aircraft requested from FMAW to support major strike efforts. TACOS aircraft will augment present A-3B assets.

(h) Search and Rescue (SAR) missions by specially configured SH-3A helicopters provided from a CVS, or CVA based UH-2B helicopters. These are in addition to 7th AF SA-16 and helicopter assets and are supported by RESCAP missions.

(i) Infrared surveillance missions by specially configured RA-3B aircraft with real time readout and target reporting.

(j) Side Looking Airborne Radar (SLAR) missions by RA-5C and 131st AVN CO OV-1B aircraft. The OV-1B provides real time readout and target reporting capability.

(k) Spotter aircraft (either A-1 or S-2E) provided during daylight hours for air spotter support to the SEA DRAGON operation (surface gunfire against certain shore and coastal waters targets between 17° and 20° N). When A-1s are used, they are authorized to attack enemy forces which threaten the SEA DRAGON forces as well as conduct of coastal recce over water.

d. Mission Planning and Preparation

(1) The general objectives and missions, certain specific tasks, and assignment of general priorities in the conduct of the war are defined by the Joint Chiefs of Staff and amplified by CINCPAC, CINCPACFLT, and COM 7th FLT. CTF-77 develops a concept of operations for employment of TF-77 in carrying out these missions and tasks in his assigned areas of

responsibility. This concept of operations includes identification of target systems, assignment of target and armed recce priorities, operating area assignments and other measures to ensure effective application and coordination of effort. Development and execution of the detailed strike and armed recce program, within the parameters defined by higher authority, is a CTG-77.0 responsibility, as is maintenance of the current status of targets and enemy activity within his area of responsibility.

(2) Mission scheduling involves both assignment of areas of operation and specific flying periods. CTF-77 makes long term assignment of primary areas of operations for individual CTGs. CTG-77.0 amplifies and may modify these area assignments. He designates time periods for operations by each CTG. CTG-77.0 also designates targets and operating periods for conduct of 7th AF operations in RP II, III, IV, and VIB in which CTF-77 is the designated coordinating authority. The details of 7th AF operations, conducted within these Route Packages, is the responsibility of 7th AF. Preparation of detailed flight schedules for Naval Units is accomplished by the individual CTG commander except that coordinated strikes involving forces of more than one CVA are scheduled by CTG-77.0. CTG-77.0 also schedules special support missions, e.g., BIG LOOK, and ECM support from 7th AF. Coordinated strikes involving both 7th AF and TF-77 forces are jointly planned and scheduled by CMDR 7th AF and CTG-77.0.

(3) Detailed mission preparation to include weapon selection and loading, aircraft and aircrew assignment and aircrew briefing is the responsibility of the individual CTG. This process is integral to the CVA or Carrier Division Staff, if one is embarked, and employs normal internal communications and procedures. Weapon selection is determined by the mission, target characteristics, tactical considerations and availability. Aircraft/aircrew assignment is based upon mission requirements and efficient employment of forces. Aircrew briefing includes:

- (a) Mission requirements, including targets for strike missions and stationing of support aircraft.
- (b) Divert/abort procedures.
- (c) Order of battle and other intelligence.
- (d) Tactical coordination with other airborne and surface units.
- (e) Restrictions and rules of engagement.

e. Mission Execution

(1) Land/launch control of aircraft, including approach control procedures, is accomplished using established carrier and shore base procedures, equipment, and voice communications circuits.

(2) Enroute control of offensive combat missions to and from the target area and control of defensive combat and support missions to and from the operating area is performed by the flight leader based on preflight briefing plus direction and advisories received while airborne from designated control ships, GCI sites and airborne control aircraft. Specific control functions including advisories and services are identified in Table 1.

(3) Tactical control of missions is exercised by the mission leader; however, a wide variety of control and coordination functions affect the tactical operation. These functions are amplified below and are presented in Table 2.

(a) Divert/abort for all missions is determined by the mission leader under the conditions specified in preflight briefing or as directed by the Officer-in-Tactical-Command (OTC) using tactical circuits and code word of the day.

(b) Control of strike, armed recce and photo recce tactical elements which may be supported by flak suppression, IRON HAND, and TARCAP, and

TABLE 1

<u>CONTROL FUNCTION</u>	<u>PRIMARY CONTROL OR ADVISORY AGENCY</u>
In-Flight refueling vectoring	CVA, Air control ships and aircraft
Identification	PIRAZ, GCI
Vectoring to Marshall Point for carrier recovery	CVA
Operations in 7th AF areas of control	GCI, ABCCC/FAC
Enroute vectoring, traffic separation	CVA, air control ships and aircraft

TABLE 2

<u>Mission</u>	<u>Control Agency</u>	<u>Remarks</u>
All missions	1. Mission Leader	a. Tactical command and coordination b. Mission divert/abort
	2. COMMANDO LANCE, BIG EYE, E1B/E2A, BIG LOOK aircraft, and PIRAZ, SAR-DL, MOTEL	a. MIG warning
	3. BIG LOOK, COMMANDO LANCE, EA-3B aircraft and MOTEL	a. SAM Warnings
	4. COMMANDO LANCE, BIG EYE aircraft and PIRAZ, MOTEL, AAWC	a. Border warnings
	5. OTC	a. Mission divert/abort
Strike/Armed Recce	1. Strike Leader, OTC	a. Divert to alternate targets
Flak Suppression	2. Strike Leader	a. Coordination of tactical elements
IRON HAND		b. Coordination with support functions
TARCAP		
Photo Recce (Includes Flak Suppression, IRON HAND, and TARCAP if assigned)	Same as strike/armed recce missions.	
TARCAP	1. E1B/E2A, PIRAZ	a. Intercept assistance in target area.

coordination of the mission with the supporting functions. is exercised by the mission leader.

(c) Defensive fighters (BARCAP and FORCECAP) are provided by each CTG and controlled by the Anti-Air Warfare Coordinator (AAWC) by advisories issued through PIRAZ and AEW aircraft. FORCECAP is maintained in condition status (deck alert) but may be airborne if directed by the AAWC. BARCAP are stationed between the area of anticipated threat and aircraft being supported. Supported aircraft include ECM, ELINT, SAR and AEW aircraft. Emphasis is placed on protection of BIG LOOK because of its vulnerability and value. BARCAP may be diverted to support of SAR missions as directed by CTG 77.0.

(d) AEW aircraft (E-1B, E-2A) for early warning and air control are scheduled by individual CTGs from embarked assets. Control of AEW aircraft is exercised by the AAWC, normally CTG 77.0.

(e) ECM jamming is provided by EA-1F aircraft, embarked in CVAs, as directed by CTGs. CTGs may request Marine EF-10B/EA-6A ECM services from the FMAW. CTG 77.0 may request EB-66 ECM jamming services from 7th AF. Requesting messages provide mission details. In-flight coordination is exercised between flight leaders.

f. The USN/USAF Enemy Warning System for Southeast Asia (Threat Alert System) has been instituted to provide timely warnings to friendly forces. MIG alerts may be initiated by BIG EYE, BIG LOOK, COMMANDO LANCE and ELB/E2A aircraft or MOTEL, SAR DD and PIRAZ. SAM warnings may be initiated by BIG LOOK, COMMANDO LANCE, EA-3B/EF-10B/EA-6A/EA-1F aircraft or MOTEL. The CHICOM Buffer Zone/Border warnings may be issued by BIG EYE, COMMANDO LANCE, PIRAZ, or MOTEL. All warnings are issued on Guard channel. The following missions support the warning systems as indicated:

(1) EC-121M (BIG LOOK) coverage for ELINT collection and MIG or SAM warning is scheduled and controlled by CTG 77.0.

~~SECRET~~

(2) EA-3B coverage for ELINT collection and SAM warning is scheduled by individual CTGs using VQ-1 aircraft embarked or shore based at NAS Cubi Point. CTG-77.0 coordinates scheduling to avoid duplication during overlap of CVA flying periods.

(3) When both BIG LOOK and EA-3B aircraft are on station (normally during overlap of CVA flying periods), BIG LOOK generally provides coverage of RPs IV and VI and the EA-3B provides coverage of RPs II and III. When BIG LOOK is not on station, EA-3B coverage is provided in the area of most concentrated operations as directed by the operating CTG.

(4) Information on SAM activity is provided by EA-1F, EF-10B, EA-6A and EB-66 aircraft. Scheduling of these aircraft is determined by ECM jamming requirements.

(5) E-1B and E-2A AEW aircraft contribute to MIG and Border warnings as a part of the early warning and air control function.

(6) BIG EYE air control aircraft provide MIG and Buffer Zone/Border warning, and other information, either directly or through crosstell. BIG EYE missions are scheduled by CMDR 7th AF in support of 7th AF operations.

(7) Tanker aircraft are scheduled and controlled by individual CTGs to meet anticipated in-flight refueling requirements.

(8) CMDR 7th AF has overall coordination responsibility for SAR efforts in the area and provides the bulk of the SAR assets. CTF-77 provides surface ships and aircraft principally to conduct off-shore SAR efforts. RESCAP, SAR helicopters and SAR destroyer positioning and schedules are directed by CTG-77.0 by daily message. In general, the pilot of the first aircraft arriving at the scene of the downed aircraft is the on-scene commander until relieved by the rescue coordinator aboard a USAF SA-16. Two RESCAP (A-1 aircraft) are normally provided as escort for SA-16 aircraft from sunrise to

~~SECRET~~

GA-9

Annex A to
Appendix G

~~SECRET~~

sunset. A SAR helicopter (SH-3A) is maintained in the vicinity of the North SAR DD during daylight hours. HU-2 SAR helicopters are maintained on a ten minute alert on both the North and South SAR DDs. In addition, an A-4 RESCAP is maintained on ten minute alert on board CVAs.

g. Post-mission procedures consist of three basic processes: reporting mission results, consolidation and analysis of results, and feedback of information to tactical commanders to facilitate direction of future operations. Two principal areas of interest exist:

(1) Target Intelligence is derived primarily from target photography but is augmented by pilot reporting, information from other sources, and by ELINT for enemy radars. Procedures for processing ELINT are discussed below under Tactical Intelligence. Information derived from pilot reports receives wide distribution through the Joint Operational Reporting (OPREP) and Mission Debrief Form (MIDEFO) systems. Such information, which includes visual bomb damage assessment (BDA), is available to and used by intelligence activities as collateral information in support of photography or as primary information where more recent photography is not available. Photography, the most reliable and accurate source of target intelligence, is processed and initial photo interpretation (PI) accomplished immediately after recovery of the photo aircraft. TF-77 materials are then forwarded to Fleet Intelligence Center, Pacific Facility (FICPACFAC), Cubi Point, Philippines, for supplementary PI, cataloguing, and limited analysis. Completed PI is accomplished at FICPAC, Hawaii. Significant PI results are reported by message at each stage. Selective reproduction and distribution is also accomplished at each stage; however, the normal channel for exchange of materials between 7th AF and TF-77 is through FICPACFAC.

~~SECRET~~

GA-10

Annex A to
Appendix G

~~SECRET~~

(2) Tactical Intelligence includes order of battle information, ship sightings, enemy activity and similar information. Of particular interest herein are the electronics, SAM, AAA, and aircraft orders of battle and related activity of these enemy systems. Reporting, compilation, analysis and distribution of this information is outlined in Table 3.

~~SECRET~~

GA-11

Annex A to
Appendix G

TABLE 3

TACTICAL INTELLIGENCE COLLECTION AND DISTRIBUTION

Agency	Source	Method of Acquisition	Processing and Distribution	Remarks
...
...
...
Fighter Air- craft Unit of

SECRET

~~SECRET~~

GA-11A

Table 3 to
Annex A to
Appendix G

~~SECRET~~

TAB B TO ANNEX A TO APPENDIX G
BIG LOOK PROJECT

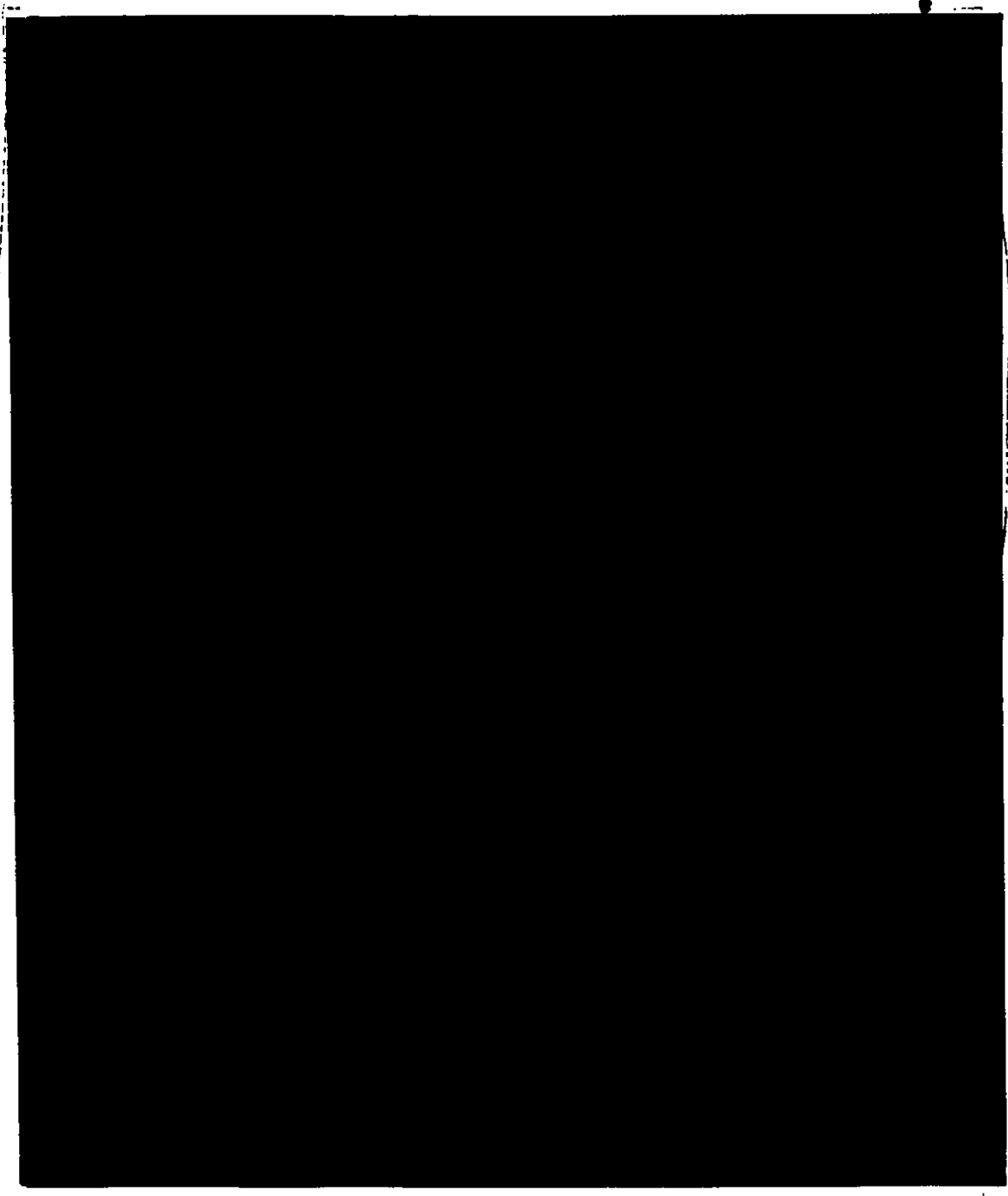

AF

~~SECRET~~

GAB-1

Tab B to
Annex A to
Appendix G

~~SECRET~~

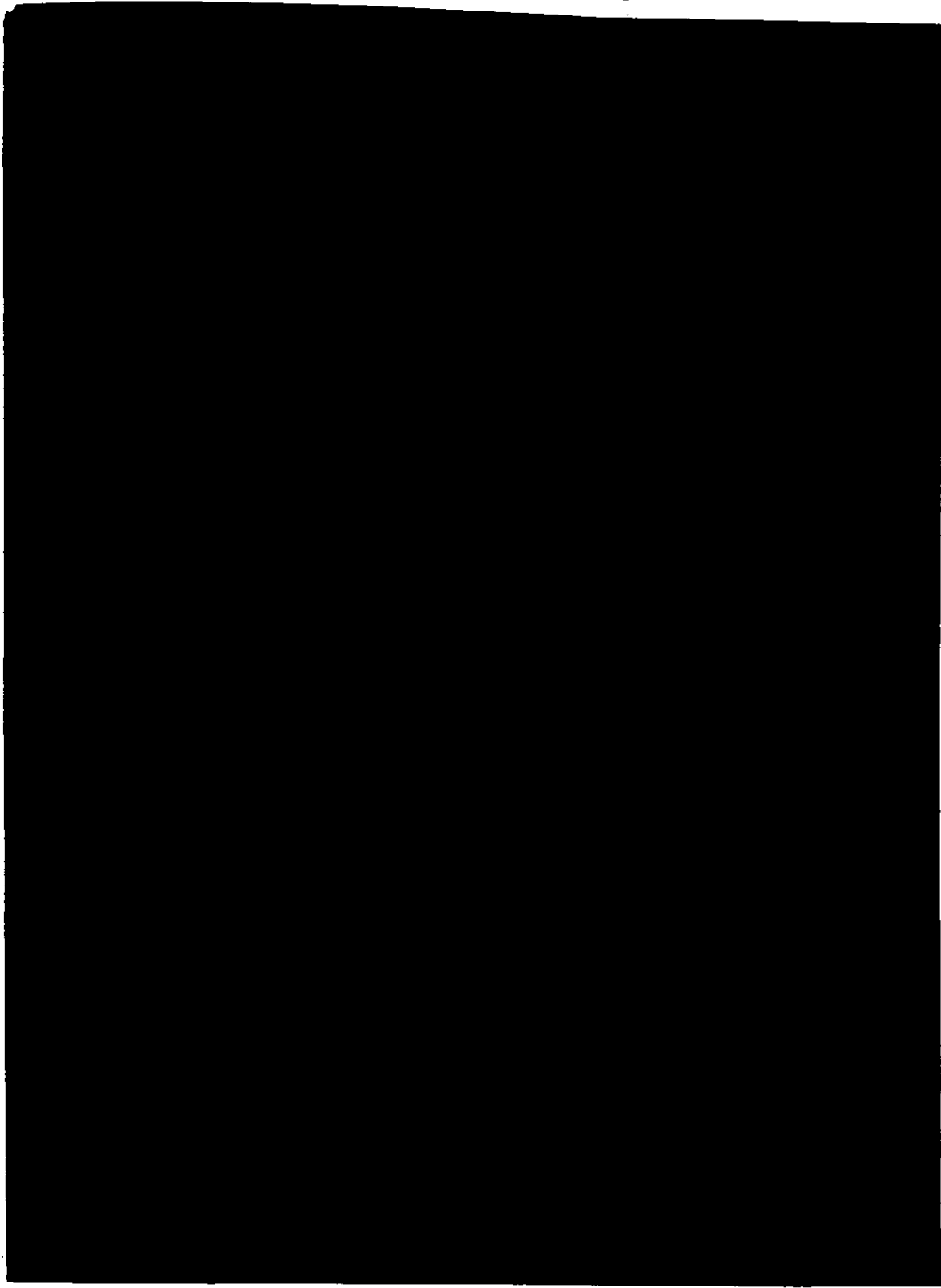

~~SECRET~~

GAB-2

Tab B to
Annex A to
Appendix G

ANNEX B TO REFERENCE C

U.S. AIR FORCE OPERATIONS

1. (C) General

a. USAF air operations in Southeast Asia are conducted under the following general categories:

(1) Air operations in the MACV area of responsibility - South Vietnam, Laos and Route Package I, North Vietnam.

(2) Air operations in the Gulf of Tonkin and in North Vietnam above Route Package I.

b. All air operations conducted by the CMDR 7th AF in Southeast Asia are integrated under the Southeast Asia Integrated Tactical Air Control System (SEA ITACS). In South Vietnam the system includes the combined USAF and Vietnamese Air Force (VNAF) activities; and in Thailand, the combined USAF and Royal Thai Air Force (RTAF) activities. USMC and USN tactical sorties made available to 7th AF in South Vietnam, Laos or RP I of North Vietnam and Free World Air Forces (currently, Royal Australian Air Force only) in South Vietnam are under operational control of the in-country Tactical Air Control Center (TACC), Tan Son Nhut Air Base.

(1) To provide essential control and coordination of USAF air operations in the Gulf of Tonkin and above RP I in North Vietnam a Tactical Air Control Center (North Sector) (TACC (NS)) has been established at Monkey Mountain, Danang. This center, with its associated radars, airborne control and warning aircraft, ELINT/ECM aircraft, radio relay aircraft and communications netting with CTF-77 provides surveillance, warning, limited control and coordination of air operations in North Vietnam and the Gulf of Tonkin as an extension of the SEA ITACS. It is subordinate to the 7th AF out-country TACC at Tan Son Nhut and is a parallel facility to the TACC at Udorn, Thailand. These three facilities control and coordinate all USAF air operations in North Vietnam above RP I, and in the Gulf of Tonkin.

(2) In view of the Terms of Reference for this study, subsequent discussion will be directed to those air operations conducted in the Gulf of Tonkin and in North Vietnam above RP 1. Seventh AF operational control and coordination organization for these operations is illustrated in TAB A.

c. Organization and Functions

(1) Command Relationships

(a) The CMDR, 7th AF functions in two capacities. As Air Force Component Commander to COMUSMACV, he conducts and coordinates air operations in the MACV area of responsibility. As a Tactical Air Force Commander, subordinate to CINCPACAF, (the CINCPAC Air Force Component Commander), he conducts and coordinates air operations in RPs V and VI A, in North Vietnam. He exercises operational control over 13 AF forces based in Thailand and commands USAF tactical forces based in South Vietnam.

(b) Command and control of USAF forces is exercised by the CMDR 7th AF through his Command Post at Tan Son Nhut Air Base. Under the direction of the Deputy Chief of Staff/Operations (DCS/O), the TACC (out-country), located at Headquarters, 7th AF, plans and controls USAF tactical air operations in the Gulf of Tonkin and above RP I in North Vietnam. Subordinate TACCs at Udorn Air Base, Thailand, and Monkey Mountain, Danang, Vietnam (TACC North Sector) exercise control and coordination functions as directed by the 7th AF TACC, out-country.

(c) The TACC, Udorn, controls and coordinates operations involving Thai based tactical forces and is responsible for the air defense of Thailand.

(d) The Deputy Commander 7th/13th AF, Thailand, commands USAF elements based in Thailand and is responsible to the CMDR 7th AF for operational control of tactical air forces based in that country. He coordinates directly with COMUSMACTHAI, the

TAB A TO ANNEX B TO APPENDIX G

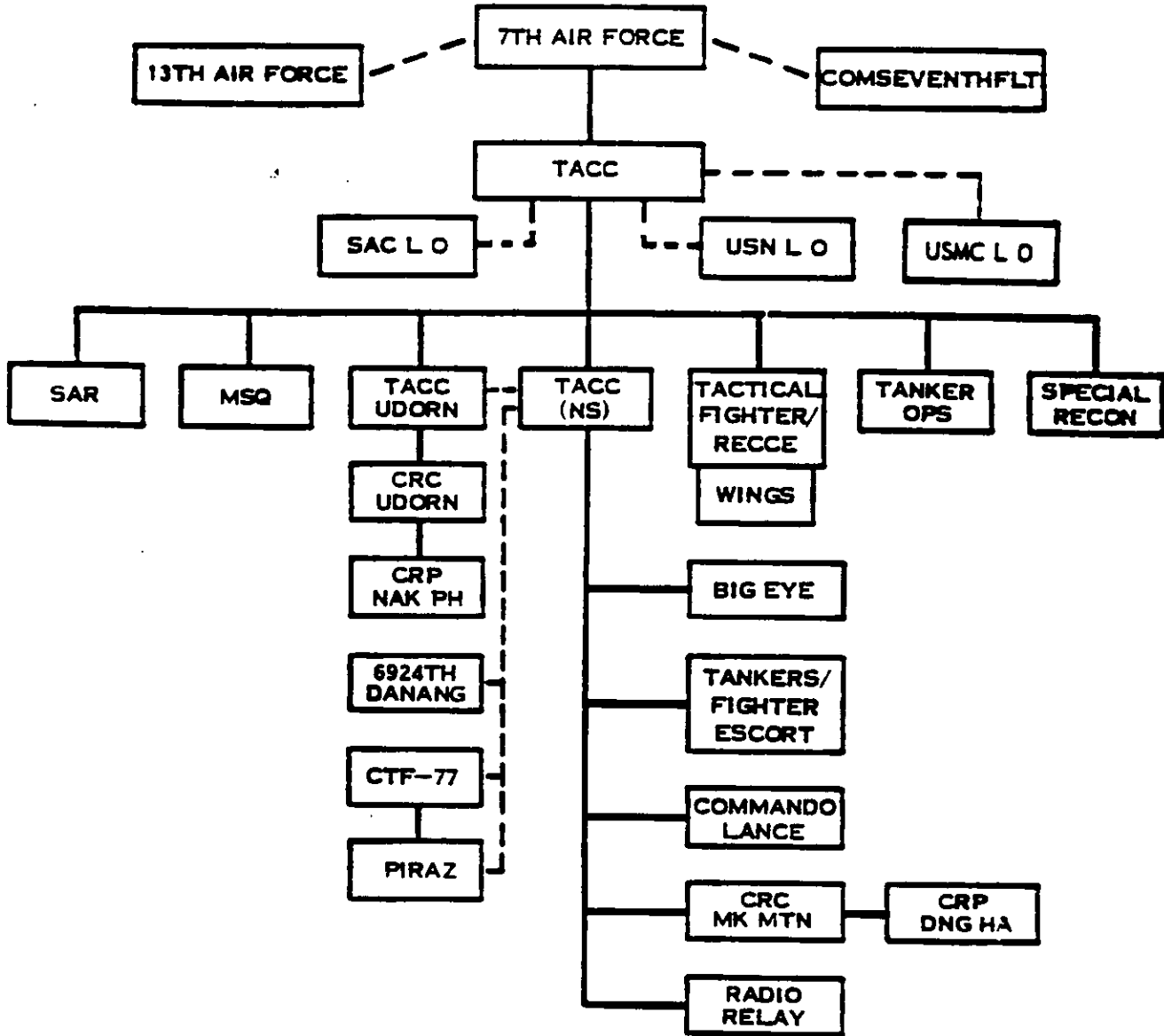

LEGEND

— CONTROL

- - - COORDINATION/ LIAISON

7TH AIR FORCE OPERATIONAL/CONTROL ORGANIZATION

~~CONFIDENTIAL~~

GBA-1

Tab A to
Annex B to
Appendix G

~~SECRET~~

US Air Attache, Vientiane and the Ambassadors to Laos, Thailand in matters of mutual interest. His headquarters is located at Udorn Air Base.

(e) The TACC(NS) at Monkey Mountain provides centralized control and coordination of USAF air operations in North Vietnam and the Gulf of Tonkin. This facility (MOTEL) is collocated with the Control and Reporting Center (CRC)(Panama) and receives data inputs from many sources. The CRCs at Udorn and Monkey Mountain provide long range search and height finder radar information, as well as SIF beacon tracking. Data from radar units subordinate to these CRCs are included in the information provided to the TACC(NS). This radar and/or SIF capability is extended through inputs from Airborne Early Warning and Control aircraft (BIG EYE) located in the Gulf of Tonkin and over Laos (see TAB B). Operational intelligence inputs are provided by the collection system of the 6924th Security Squadron at Danang, and by COMMANDO LANCE. Additionally, a teletype readout in the TACC(NS) provides information from the Naval Tactical Data System (NTDS). A Navy officer on duty in the TACC(NS) assists the Battle Commander in effecting the coordination of USAF/USN operations and the passing of essential data to and from PIRAZ/CVAs. The present manual system for coordination and control is being updated to a semi-automated system. A detailed description of this system (BUIC II), its functions and capabilities is contained at TAB B, Annex F. USN/USMC and SAC liaison officers within the TACC (out-country) coordinate joint operations with 7th AF. A 7th AF/CTF-77 Coordinating Committee meets monthly at either 7th AF or CTF-77 headquarters.

d. Identification of Functions Involved in Conduct of Air Operations Against North Vietnam.

(1) Offensive Combat Missions.

(a) Strike/armed reconnaissance missions by fighter aircraft. Strike may be conducted visually or under control of MSQ-77 radar (COMBAT SKYSPOT).

~~SECRET~~

GB-3

Annex B to
Appendix G

(b) Flak suppression missions in support of strikes against targets defended by AW and AAA. Normally, this mission is performed by the same units performing the strike.

(c) IRON HAND missions against SA-2 installations by specialized aircraft (WILD WEASEL) equipped with radar homing and warning systems. These missions are flown independently and in direct support of strike/armed recce/photo recce operations.

(d) MIG CAP missions by fighter aircraft as a counter-air function during strike/armed recce/photo recce operations. These fighters are normally loaded with both air-to-ground and air-to-air ordnance and perform dual missions.

(e) Fighter sweeps for the purpose of seeking out and destroying enemy fighter aircraft in the air. These aircraft are loaded with air-to-air ordnance only.

(f) Heavy bombing missions against selected targets outside SAM threat areas.

(2) Defensive Combat Missions.

(a) Fighter cover for BIG EYE, COMMANDO LANCE, WAGER (Airborne radio relay) and tankers operating in the Gulf of Tonkin.

(b) Air defense interceptor missions flown from ground alert at Danang Air Base on an "as required" basis.

(3) Combat Support Missions.

(a) Airborne Early Warning and Control (BIG EYE) missions by EC-121 aircraft provide an extension of surface radar coverage. The primary mission of these aircraft is to provide warnings to US tactical aircraft of enemy fighters and of proximity to the CHICOM border/buffer zone, as well as control of fighter cover for COMMANDO LANCE, WAGER, tankers, BIG EYE, BIG LOOK and other EW aircraft.

(a) Special Intelligence missions are provided by KC-135 (COMBATWING LANCE) aircraft. Details on missions of these aircraft are contained in Volume III of this study.

(c) Reconnaissance missions are provided by RF-4 and RF-101 aircraft. Photo, infrared and radar recce, and Bomb Damage Assessment (BDA) photography are routine missions of these aircraft.

(d) Electronic Countermeasure (ECM) jamming is provided by EB-66 aircraft against SAM and AAA radars. With the advent of the QRC-160 ECM pod, strike aircraft are providing their own SAM/AAA radar jamming.

(e) Radio Relay service is provided by KC-135 (WAGER) aircraft for a UHF radio link between the TACC(NS), MOTEL, BIG EYE, TACC (UDORN), tactical fighter/recce aircraft over North Vietnam and PIRAZ (RED CROWN).

(f) In-flight refueling support is provided by KC-135 tankers. USAF strike aircraft operating north of RP I normally require air-refueling for each sortie. Fighter escort for support aircraft in the Tonkin Gulf are refueled from on-station tankers in the Gulf. Tanker support is provided from Thai bases and from Okinawa.

(g) Search and Rescue (SAR) support is provided by HU-16 and CH-3 aircraft. Fighter RESCAP is provided as required. CTF-77 helicopters provide SAR support in central and northern gulf and coastal regions of North Vietnam.

e. Mission Planning.

(1) Target Selection and Assignment.

(a) Targets selected for strike may be placed in the following general categories: Those ALPHA targets directed by the Joint Chiefs of Staff for strike during a specific period; other targets selected from the ALPHA target list which have been previously approved for strike by the Joint Chiefs

of Staff; other targets selected from nomination lists prepared by CINCPAC, CINCPACAF, and 7th AF under Joint Chiefs of Staff authorization; other targets in Joint Chiefs of Staff approved armed reconnaissance areas. In addition, strikes are conducted against SAM sites and AAA sites as necessary and in support of other strike operations authorized.

f. Mission Scheduling and Notification.

(1) Terms of reference, authorization and direction for tactical operations conducted by USAF are provided by Operations Orders. Specific missions to be performed under the general direction of the Operations Order are directed by a fragmentary operations order(s) (frag order(s)). A frag order provides: targets to be struck, routes, altitudes, times, tanker tracks, support aircraft orbit areas, force strengths, coordination requirements, ordnance to be carried, enemy order of battle, as appropriate; and restrictions and other information and instructions essential to effective and orderly accomplishment of the mission. Liaison sections from the USN and SAC are responsible for coordination with their respective activities and elements to insure maximum effectiveness in accomplishment of the joint mission. These liaison activities assist the 7th AF staff in preparation of the frag order involving their respective commands. The frag orders are issued in teletype format and addressed to action agencies as well as all other agencies to whom the mission may be of concern or direct interest. CTF-77, TP-77 carriers and the PIRAZ ship are addressees on every 7th AF frag order and amendments thereto involving USAF operations within the PIRAZ. These orders are transmitted in sufficient time prior to mission launch to allow action by addressees and changes/clarification of procedures, if required.

(2) Ordnance to be carried on each strike and fighter escort or CAP mission is determined by 7th AF Staff after detailed analysis and application of weaponeering techniques. Ordnance loads directed in the frag orders, except in unusual circumstances, are adhered to by tactical units.

a. Mission Execution

(1) Tactical and support aircraft are launched on a time phased basis to avoid congestion enroute and in target areas. However, seasonal weather in North Vietnam target areas requires occasional sortie compression into a relatively short time period to obtain the desired weight of effort against selected targets in the ROLLING THUNDER program. It is during these periods that the greatest demand is placed upon the coordination and control system. Mission planning for large operations is closely coordinated with CTF-77 through the USN Liaison Office to insure most effective control and least possible interference in the Gulf of Tonkin.

(2) Mission aircraft, following take-off, are tracked by the tactical air control system from base of origin to the target area. Positive control is maintained by either ground or airborne radars during air-refueling operations. Flights are forward or crosstold between radars as appropriate and track information is maintained on all enroute tactical aircraft. Information concerning USAF flights which will enter the PIRAZ is passed from the TACC(NS) at Monkey Mountain by crosstell to the PIRAZ ship. AM/SSB HF circuits between TACC(NS) and PIRAZ are used for this purpose as well as for passing other operational information of mutual interest. In the near future a secure voice UHF link will be available between these agencies through the Airborne Radio Relay.

(3) Each aircraft flight provides radar identification through use of preplanned IFF/SIF selection. Mode 3, with associated codes, is used in Laos, South Vietnam and RP I, and Mode 2, with code, is used in the Gulf of Tonkin and North Vietnam above RP I. Specific flights may be identified by the SIF mode/code published in the frag orders. The crosstell information from TACC(NS) to PIRAZ on inbound flights is correlated with the frag order information for positive identification. All aircraft are required to display the directed IFF/SIF mode/code throughout the flight. Upon withdrawal from the target

~~SECRET~~

areas, via the Gulf of Tonkin, all USAF aircraft make a common frequency UHF call to PINAZ and BIG EYE. This provides control agencies positive identification of aircraft entering both the USN and USAF radar identification areas when outbound from North Vietnam.

(4) During tactical operations in North Vietnam, ELINT and ECM are accomplished from a stand-off position outside SAM threat areas by C-130 and EB-66 aircraft. Strike aircraft are equipped with ECM pods (QRC-160) to jam SA-2 acquisition and guidance radars, and recon aircraft will be equipped with pods in the near future. Most strike recon aircraft are equipped with radar homing and/or warning systems (RHAW) to provide warning of SAM acquisition and guidance radar operation. Additional SAM warning is provided aircraft operating over North Vietnam by MOTEL, and BIG LOOK and COMMANDO LANCE aircraft operating COMINT/ELINT/Radar equipment over the Tonkin Gulf. These warnings, as well as warnings of MIG activity and friendly tracks approaching the Chinese buffer zone/border are passed over guard channel, in the clear.

(5) During ROLLING THUNDER operations, a C-130 (COMMANDO LANCE) is employed in the Gulf of Tonkin for the purpose of obtaining communication intelligence. EC-121 aircraft (BIG EYE) are maintained on station over Laos and in the Gulf of Tonkin to provide tracking and control of USAF aircraft and to pass advisories/warnings to all aircraft. To provide fighter cover for these operations, a flight of four aircraft is maintained on station in the Gulf as a defensive combat air patrol (MIG CAP). In order to maintain fighter aircraft on station during the ROLLING THUNDER period of operations, air refueling is provided by tankers orbiting in Laos and the Gulf. The fighters then have the responsibility for covering the BIG EYE, COMMANDO LANCE, and tanker aircraft. Periodically, a photo recon drone is launched over North Vietnam by a C-130 operating in the Gulf of Tonkin (BLUE SPRINGS). Although fighter escort is periodically required for this mission, normally the fighter MIG CAP described above will assume cover responsibility for BLUE SPRINGS.

~~SECRET~~

GB-8

Annex B to
Appendix G

~~SECRET~~

(6) The MIG EYE EC-121 aircraft is radar and IFF/SIF equipped and is an extension of the 7th AF AC&W subsystem. See Tab E.

(7) As a suppression force against SA-2 missile systems in North Vietnam, fighters with ELINT/RHAW equipment are employed in conjunction with ROLLING THUNDER operations. These aircraft (IRON HAND/WILD WEASEL) have a primary mission to detect, locate, and attack SAM sites. They employ the AGM-45 (SHRIKE) missile as well as other munitions/weapons such as rockets, cannon, and CBU. This operation is integrated and coordinated with the general strike mission.

(8) Flak suppression, other than the IRON HAND/WILD WEASEL anti-SAM effort, is normally accomplished as an integral strike flight function. It is a normal part of attack against heavily defended targets, wherein a designated flight of an attack formation delivers CBU-24/29 against flak defenses.

(9) The ECM pods (QRC-160) enhance control capability over North Vietnam in that they permit strike aircraft to remain at a penetration/withdrawal altitude of 14 to 15 thousand feet. Aircraft at this altitude, employing IFF/SIF, can be tracked by friendly ground, sea, and airborne radars over most of North Vietnam.

(10) A coordinated search and rescue system is operated in the Tonkin Gulf. Seventh AF maintains an SA-16 on orbit in the southern part of the Gulf of Tonkin and CH-3 helicopters are constantly on ground alert for rescue support of operations in North Vietnam. USN rescue aircraft from TF-77 provide support for USAF operations in the northern regions of North Vietnam and Gulf of Tonkin. Fighter cover for SAR operations in northern areas is provided by TF-77 CAP fighters or diversion of 7th AF strike aircraft. In Laos, SAR escort (RESCAP) is normally provided by A-1 aircraft launched from Udorn/NAKHON PHANOM concurrently with the CH-3 SAR aircraft.

(11) Photo reconnaissance in North Vietnam is accomplished by RF-4 and RF-101 aircraft based at Udorn and Tan Son Nhut. Special photo reconnaissance

~~SECRET~~

GB-9

Annex E to
Appendix G

is accomplished by the C-130/drone (BLUE SPRINGS) and SAC U-2 aircraft (TROJAN HORSE). TROJAN HORSE has been temporarily discontinued but is expected to renew photo recce operations in the near future. This activity is sensitive and is conducted outside the Southeast Asia tactical air control system under a direct mission directive from the Joint Chiefs of Staff to SAC. Other reconnaissance missions as directed by the Joint Chiefs of Staff are conducted in the Gulf of Tonkin and North Vietnam. These sensitive operations have operated outside the USN/USAF control systems. Aircraft involved have not presented an identification and control problem in view of the limited frequency of operation, direction of approach and the permissive air defense environment which has prevailed.

(12) Leaflet drops are conducted over North Vietnam by C-130 and F-4 aircraft. These and other special operations by USAF and VNAF aircraft, operating under MACV Operation Plan 34A, are conducted under 7th AF frag orders and by execute orders issued by the MACV Combat Operations Center (COC) for Special Operations Group (SOG) aircraft.

h. Post-Mission Procedures

(1) Following recovery from tactical combat missions, aircrews receive an intelligence de-briefing in a continuing program to update/verify enemy air defense order of battle, assess effectiveness of enemy air defenses, obtain visual BDA, and any other information which might improve effectiveness.

(2) Operations critiques are held by squadrons and wings for the purpose of analyzing tactics and techniques.

(3) Reports are submitted under the CINCPAC OPREP and MIDEFO systems.

(4) Following recovery of photo recce aircraft, film is processed under a priority system with emphasis upon earliest Photo Interpretation (PI) of film involving enemy air defenses and BDA.

~~SECRET~~

TAB B TO ANNEX B TO APPENDIX G

BIG EYE

1. (S) EC-121 Airborne Early Warning and Control Aircraft (BIG EYE) serve as extensions of the ground based aircraft control and warning elements, providing radar and/or IFF/SIF data to the TACC(NS). They operate from two assigned stations (one high, one low) over the Gulf of Tonkin and one high station over Laos.

2. (S) The low station (Alpha) in the northern part of the Gulf of Tonkin is occupied during the conduct of air operations against North Vietnam. Operating at 300 to 500 feet, aircraft manning this station provide radar and IFF coverage down to 6000 feet over the Hanoi area. Information is passed by this platform to the TACC(NS) via HF/SSB and/or by UHF through the KC-135 radio relay.

3. (S) The high station in the Gulf of Tonkin (Bravo) is flown at an altitude of 12,000 feet or above. This aircraft depends primarily on SIF to identify the track friendly aircraft operating over North Vietnam. Information is passed directly to the TACC(NS) by Secure UHF (using KY-8s) or by HF/SSB.

4. (S) Another high station (12,000 feet or above over northern Laos), provides IFF identification and tracking data on friendly forces operating in North Vietnam. Information from this aircraft is passed to the TACC(NS) by Secure UHF through the Udorn CRC or by HF/SSB to either Udorn or Monkey Mountain. This aircraft can also get information directly to the TACC(NS) through the KC-135 radio relay aircraft.

5. (S) Aircraft manning these three stations operate from a Forward Operating Base (FOB) at Ubon, Thailand. The BIG EYE fleet presently consists of only eight aircraft, which precludes manning the Bravo station on a daily basis. The Joint Chiefs of Staff are presently considering a CINCPAC request to increase the force to 11 aircraft in order that all three stations can be manned

~~SECRET~~

TOP-1

Tab B to
Annex B to
Appendix G

~~SECRET~~

during periods of air activity against North Vietnam. Action is expected to be completed, and aircraft in place in Southeast Asia before the end of April, 1967.

6. (S) Improvements expected prior to the end of FY 67 include:

Installation of QRC-248 and Cross-up. Approval for use of QRC-248 has been obtained and aircraft will be modified and equipment installed at McClellan AFB. One aircraft with this equipment is now in theater. Three more aircraft are scheduled to be in theater by 17 April and all 11 aircraft should have equipment installed and operating by 5 June 1967. With this equipment, BIG EYE aircraft will be able to identify and track friendly/hostile aircraft with operating IFF.

7. (S) Other Improvements Expected in FY 68 Are:

a. Installation of GPA-122 IFF/SIF Decoder (Active/Passive). This equipment is presently being installed on ground radar scopes in Southeast Asia and action is underway to have it installed in BIG EYE aircraft, prior to end FY 67. Mode 2 IFF is automatically read-out to the scope operator through use of a light gun and Modes 1 and 3 are displayed by setting in the desired codes. This equipment enhances the identity and tracking functions by increasing the operator effectiveness in capability and speed of identification.

b. Installation of Radar Data Processor in Present BIG EYE Force or Replacement of This Force with ALRI EC-121s. Study is presently underway to determine the fastest and most feasible approach to providing automatic track output information to the BUIC computers. ALRI (Automatic Long Range Input) aircraft are already providing this type of input into SAGE and BUIC on the US east coast and may possibly be used to replace the current manual operating BIG EYE aircraft. Another near-term possibility is the use of current off-the-shelf equipment, installed in the present BIG EYE fleet, to provide automated data inputs to BUIC. It is expected that one of these actions will be undertaken in early FY 68.

~~SECRET~~

GBB-2

Tab E to
Annex B to
Appendix G

c. Installation of Secure HF/SSB. The present keying equipment to make aircraft HF/SSB secure is too large for use in EC-121 aircraft. Efforts to secure this means of transmission with solid state or smaller equipment are being aggressively pursued to gain this capability in the shortest period of time.

8. (S) Follow-on Equipment (Beyond 1968):

a. Headquarters, USAF is currently evaluating an improved airborne command and control system to replace the BIG EYE high station aircraft and the airborne radio relay. This system, Tactical Airborne Control and Surveillance (TABCAS), incorporates an improved beacon tracking capability, a secure automatic data processing interface with SEEK DAWN, and increased secure radio relay capability. Installed in a large jet aircraft, the improved altitude capability, combined with improved beacon tracking, will extend the low level surveillance and control capability beyond the Chicom border area. Incorporation of the QRC-248 will provide all-altitude tracking of hostile aircraft.

b. Airborne Warning and Control System (AWACS). This system, under development by the Air Force, is the approved program to provide a new, state of the art, replacement for the current airborne control and surveillance systems. The greatest single achievement of this system will be the capability of radar surveillance over all types of terrain (non existent in current systems). Scheduled to enter the inventory in FY 72, AWACS will be employed in Southeast Asia if hostilities extend through that time period.

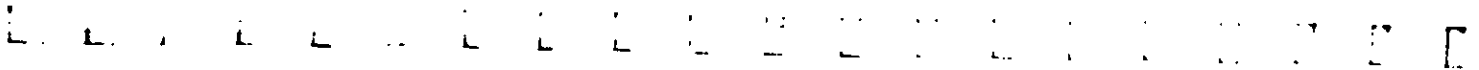

~~SECRET~~

ANNEX C TO APPENDIX G

MARINE CORPS OPERATIONS

1. (S) General

a. Marine Corps forces operating throughout the Pacific area are under the command of the Commanding General, Fleet Marine Forces Pacific (CG FMFPAC). Marine forces are presently operating extensively throughout the Western Pacific in both a direct and supporting role to the US effort in the Mainland Southeast Asia Region. Command and control of Marine forces operating ashore in South Vietnam is assigned to the CG, III MAF. CINCPAC has directed that the III MAF operate as a uni-service force under the operational control of COMUSMACV.

b. The command and control of Marine air units operating in the Mainland Southeast Asia Region is vested in the CG, III MAF. This authority has been further delegated to the Marine Tactical Air Commander (TAC), the CG FMAW. The CG FMAW commands all Marine air units to the Republic of Vietnam (RVN) and exercises this authority through the use of the Marine Air Command and Control System (MACCS) (see Tab A) in accordance with established doctrine and basic mission concepts. Some minor modifications have been made by joint FMAW-7th AF agreement to this doctrine and concepts in order to provide an interface with the Tactical Air Control System (TACS) of COMUSMACV and CDR 7th AF.

c. For the purposes of this study, only procedures which apply to the coordination and control of Marine air, out-country (Laos, North Vietnam, and Gulf of Tonkin) operations will be identified and discussed. In addition, this discussion will be limited to those procedures required to interface with those of COMUSMACV, CDR 7th AF, and CTF-77 and herein identified and described.

~~SECRET~~

GC-1

Annex C to
Appendix G

2. (S) Organization and Function

a. The FIRST Marine Aircraft Wing (FMAW) is assigned the resources required to conduct combat air operations in support of the III MAF in the Mainland Southeast Asia Region. The CG FMAW exercises command and control through Marine Aircraft Group (MAG) commanders and the assigned MACCS. Direct liaison and coordination are maintained with CDR 7th AF through a designated Liaison Officer at the 7th AF TACC in Saigon, and similarly, the 7th AF provides a Liaison Officer at the FMAW Headquarters in Danang. Additionally, liaison with CTF-77 is maintained in certain matters pertaining to electronic warfare through a designated FMAW representative located in the Navy Liaison Office (NLO), 7th AF TACC, Saigon. Direct liaison with these commands for certain matters pertaining to air operations has been authorized by COMUSMACV. Personnel and equipment required to support air operations are provided by the Marine Air Group Commanders. For out-country combat operations, these are generally limited to air traffic control facilities required for air base operations, positive air control within the III MAF Tactical Area of Responsibility (TAOR), internal communications, and the tactical aircraft and resources required to perform the air missions.

b. The Marine Air Command and Control System (TAB A) provides the TAC a system which enables him to coordinate and supervise air operations, but at the same time, has the flexibility to permit some supervised decentralization of control authority to subordinate control agencies. The parts of the system involved in out-country operations are:

(1) A Tactical Air Direction Center (TADC) located in the FMAW Command Post at Danang.

The TADC receives air operations data from all external sources, including the TAOC, the FACP, the PANAMA CRC and TACC(NS) and the COMUSMACV/7th AF TACC in Saigon and presents this data in a manner that the TAC can carry out his command functions and responsibilities.

(2) A Tactical Air Operations Center (TAOC) at Chu Lai.

The TAOC provides the TADC with the necessary information and facilities to effect control in the Chu Lai Sector of responsibility. In addition, it operates in close coordination with the Air Defense Battle Commander (ADEC) located at the 7th AF TACC(NS) (MOTEL) at Monkey Mountain, Danang.

(3) A Forward Air Control Post (FACP) at Phu Bai.

The FACP provides gap filler radar and communications facilities for the TADC and the 7th AF CRC, Monkey Mountain. At the present time this facility is under the coordination and control of the PANAMA CRC.

c. The present system is essentially a manually operated system. However, by June 1967, a major portion of the Marine Tactical Data System (MTDS) will be in place on Monkey Mountain (Hill 647). The MTDS will provide, by automatic means, the capability to conduct Marine air operations including the functions of detection, identification, and tracking of airborne targets, the assignment and control of interceptors, the coordination of SAM units, the assignment of air support aircraft to air support units, and enroute air traffic control. By August 1967, a Tactical Data Communications Central (TDCC), as an integral part of the MTDS at Monkey Mountain, will provide a digital data link between MTDS and the Navy Tactical Data System (NTDS) and Airborne Tactical Data System (ATDS) located aboard Navy ships and aircraft, so equipped and located in the Mainland Southeast Asia Region and the Tonkin Gulf. (See TAB E). The TDCC is the component through which USAF and NSA digital data systems will interface with NTDS/MTDS when the USAF and NSA data systems become operational. At this time, there are no major procedural changes required. Some may eventually be required because of the anticipated improvement in both the quantity and quality of air operational data available and the speed with which it is processed.

~~SECRET~~

d. The equipment utilized in the support of Marine air operations in out-country operations include equipment provided by III MAF, COMUSMACV/COMBATTAF, and C1F-77. These equipments are identified and described in their respective parts of this study. Identification and discussion of the equipment provided by III MAF/FMAW is included in paragraph 4, Annex D of this Appendix.

e. A Marine Air Traffic Control Unit (MATCU) is provided by MAG-12 at Chu Lai for the purpose of providing all-weather air traffic control in and out of the Chu Lai air base control area. An identical capability is provided for Marine aircraft by 7th AF activities at Danang. Radar and Communication equipment and facilities required are an integral part of the systems provided by the MAGs.

f. Tactical aircraft and associated resources required to perform out-country air operations are generally supplied by four MAGs, e.g., MAG-11 at Danang, MAG-16 (SAR-Helo augmentation) Marble Mountain, and MAG-12 and 13 located at Chu Lai. In addition to in-country air support requirements, these aircraft are performing the following out-country missions/functions:

- (1) Strike and Armed Reconnaissance (F-4, F-8, A-6, A-4).
- (2) Night/All-Weather Radar Controlled Strikes (F-4, F-8, A-6, A-4).
- (3) Air Defense Air-to-Air Intercepts (F-4 and F-8s)
- (4) Photo, Infrared, and Radar Reconnaissance (RF-4, EF-10B, EA-6A).
- (5) Electronic Countermeasures (EF-10B, EA-6A)
- (6) Fighter Escort/Combat Air Patrol (F-4, F-8)
- (7) In-Flight Refueling (A-4, KC-130)
- (8) Search and Rescue (UH-1H, CH-46, UH-1E)

~~SECRET~~

GC-4

Annex C to
Appendix B

VI. Allocation and Control Procedures

In accordance with an agreement between COMUSMACV and CG III MAF, the CG FMAW identifies and assigns to the CMDR 7th AF for coordination and control through the IACS, those daily USMC aviation assets not required for III MAF support so that such resources may be allocated in support of other forces or missions, both in and out-country. These assets are then assigned and scheduled by CMDR 7th AF on the daily 7th AF fragmentary (frag) order in the same manner described for USAF assets. The daily 7th AF frag order is forwarded to the CG FMAW wherein those assigned missions affecting USMC assets are included in the daily FMAW frag order covering all Marine air operations. In general, through mutual liaison and consent, the 7th AF frag order will assign USMC assets by MAG because of the different aircraft classes/models available in the respective Groups. In response to the FMAW daily frag order and the 7th AF daily frag order, which is available at the MAG level for coordination information, the Commanding Officer/Staff of the MAG assigns the mission to the appropriate squadron for execution. The squadron, then makes the specific air crew and aircraft assignments.

(1) An exception to the above procedures exists when Marine intelligence sources confirm the existence of vital targets in the vicinity of the DMZ in RP I in North Vietnam. If it is determined that immediate destruction of these targets is vital and necessary, the CG FMAW, by verbal agreement with CMDR 7th AF, can conduct immediate strikes upon such targets, provided that the 7th AF Command Post is notified prior to initiating the attack.

(2) Special mission requirements for Marine assets to augment CTF-77 operations, such as electronic countermeasure support, are forwarded simultaneously to the NLO at the 7th AF Command Post, Saigon and to CG FMAW. These requirements are then coordinated with other operations...

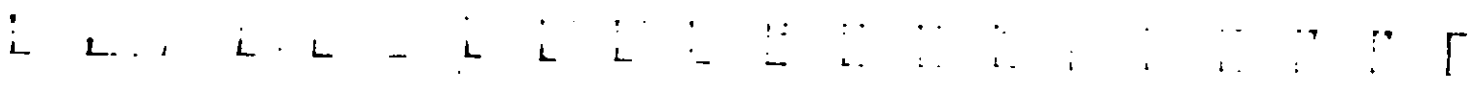

~~SECRET~~

7th AF Command Post, Saigon and placed on the daily 7th AF and FMAW frag order.

(3) In the event COMUSMACV declares a major emergency, CG FMAW is prepared to provide the CMDR 7th AF, for operational control, such air resources as designated by COMUSMACV.

(4) FMAW message frag orders covering a period 0600-0600H for the following days' operations are issued daily.

(5) Daily frag order information is passed to and held by all Navy, Marine, and USAF air coordination and control activities.

b. Target Selection/Assignment

Target selection and assignment for Marine air forces is made by CMDR 7th AF (TACC-Saigon) and coordinated with the FMAW Liaison Officer at the 7th AF Command Post, Saigon. Target dossiers are prepared by the MACV/7th AF Intelligence Center in Saigon on all appropriate targets and forwarded in advance to the FMAW. In general, adequate numbers of each target dossier are forwarded to permit each MAG and the Wing Headquarters to retain copies, and in addition, have sufficient copies for the strike air crews. Normally an adequate amount of general photographic coverage and enemy order of battle information is available at the Wing and Group Headquarters to fulfill air crew needs for unscheduled missions. Track and station positions and time data required for those missions lacking specific target assignments, e.g., electronic countermeasure, in-flight refueling, reconnaissance, and search and rescue missions, are provided by either the 7th AF or CTF-77 to the 7th AF Command Post, Saigon. It is then either placed in the daily 7th AF frag order, or relayed by direct communications to the FMAW TADC, depending upon the urgency.

c. Ordnance Scheduling

Ordnance to be carried on all Marine aircraft.

~~SECRET~~

GC-6

Annex C to
Appendix G

d. Marine aircraft involved in out-country operations report through the MACCV to the 7th AF TACS. Once these aircraft have reported in to the 7th AF TACS, coordination and control procedures are identical to those prescribed for 7th AF aircraft. Special missions flown by Marine aircraft in support of CTF-77 air operations adhere to 7th AF procedures until they report in to a CTF-77 air control facility. At that time, and while in CTF-77 areas of responsibility, the aircraft adhere to the coordination and control procedures herein described for CTF-77 air operations.

5. (S) Post Mission Procedures

a. Aircrews returning from missions report to the MAG Headquarters for debriefing. Debriefing is conducted in accordance with a FMAW standardized debriefing form. This form is completed by MAG staff personnel, verified by the air crew, and forwarded to the FMAW Headquarters. FMAW staff personnel convert the data provided on the debriefing form to digital information on a Mission Data Collection Sheet (MDCS) and transmit it by secure communications to higher commands, e.g., COMUSMACV/7th AF, CINCPAC, and the Joint Chiefs of Staff.

b. Timely reporting of perishable intelligence data collected by air crews is transmitted most expeditiously by either direct secure voice or by "flash" priority message communication to COMUSMACV/CMDR 7th AF in Saigon.

c. Photo or other sensor data recordings obtained during strike missions flown in support of 7th AF/CTF-77 requirements are forwarded by the most rapid means (air delivery) in accordance with 7th AF/CTF-77 established procedures herein described.

d. Special Electronic Warfare reconnaissance information is forwarded in standard TOP SECRET format to higher Headquarters in the same manner as described above.

~~SECRET~~

ANNEX D TO APPENDIX G

COMMUNICATIONS

1. (S) Inter-Service Coordination and Control Communications

a. Control of US air operations over North Vietnam is exercised jointly through the 7th AF TACC (NS) at Monkey Mountain near Danang and the USN PIRAZ ship in the Gulf of Tonkin. Control is based on the collection, exchange and correlation of all available information from surface and airborne sensors as well as the direction of commanders. Near real time voice coordination among widely separated sensors and control centers is principally effected on unsecured UHF (radio relay) and HF SSB circuits. Limited point-to-point secure voice circuits are available within the Integrated Wide Band Communication System (IWCS). In addition, the Navy STEAM VALVE system provides a very limited capability for ship/shore HF secure voice but has proven to be cumbersome and unreliable to the operators. While some short range UHF voice coordination circuits are cryptographically protected with the KY-8, the use of the KY-8 is limited to surface units and certain large aircraft, due to its size and availability. A miniaturized version of the KY-8, the KY-28, is being procured for FY 68 installation in tactical aircraft. This will extend voice security from the control centers to strike aircraft.

b. The essential voice and teletype coordination circuits necessary to support 7th AF operations at Monkey Mountain and CTF-77 PIRAZ/NTDS operations in the Gulf of Tonkin are shown in TABS A and B.

2. (S) Communications (Navy)

a. General. Tactical communications supporting North Vietnam air operations include UHF voice used by tactical aircraft. Support communications employed by other air and surface units, including High Frequency (HF) voice, radio teletype and data equipment for long range (beyond line of sight)

~~SECRET~~

~~SECRET~~

communications. These units employ UHF or VHF for short range communications incident to air operations and, to a lesser degree, for surface operations. The following is a description of communications directly and indirectly involved in YANKEE TEAM operations. TAB C is an overview of 7th FLT communications in the area. The elements and programs shown in TAB C are keyed to paragraphs in this annex where they are discussed. When applicable, items are cross referenced to other sections of the report.

b. Tactical Aircraft Communications

(1) Carrier strike aircraft utilize UHF voice communications for mission coordination and execution. This includes coordination involved in aircraft launch and recovery and control of the aircraft while airborne. Most of the voice UHF communication equipment employed is of the standard 225-400 megacycle, 1750 channel type. A few aircraft have 3500 channel versions which permit tuning in 50 kilocycle increments, vice 100 kilocycle tuning in the 1750 channel equipment. Tactical aircraft communications, in general, are limited to UHF primarily by antenna considerations. Lower frequencies require large antennas which are mechanically incompatible with high performance aircraft. While VHF is used in some aircraft, it is not widely used in strike aircraft. Various relay systems (MIDDLE-MAN concept) are employed to relay UHF transmissions to and from strike aircraft. Included are UHF relay devices in escort ships and support aircraft such as the E-1B and E-4. Larger aircraft such as the EC-121M (E-121C) provide UHF relay service in addition to radar and ELINT advisory functions. Air-to-air data transfer required in the NTDS/ACDS function is accomplished on UHF. Additionally, the E-4 has a HF air-to-surface data transfer capability. Cryptographic protection of these data links is to be achieved during 1967.

(2) A program has been initiated for implementation during FY 66 which will provide UHF voice security devices for tactical aircraft. These devices (KY-28) will permit immediate

~~SECRET~~

TAB A TO ANNEX D TO APPENDIX G

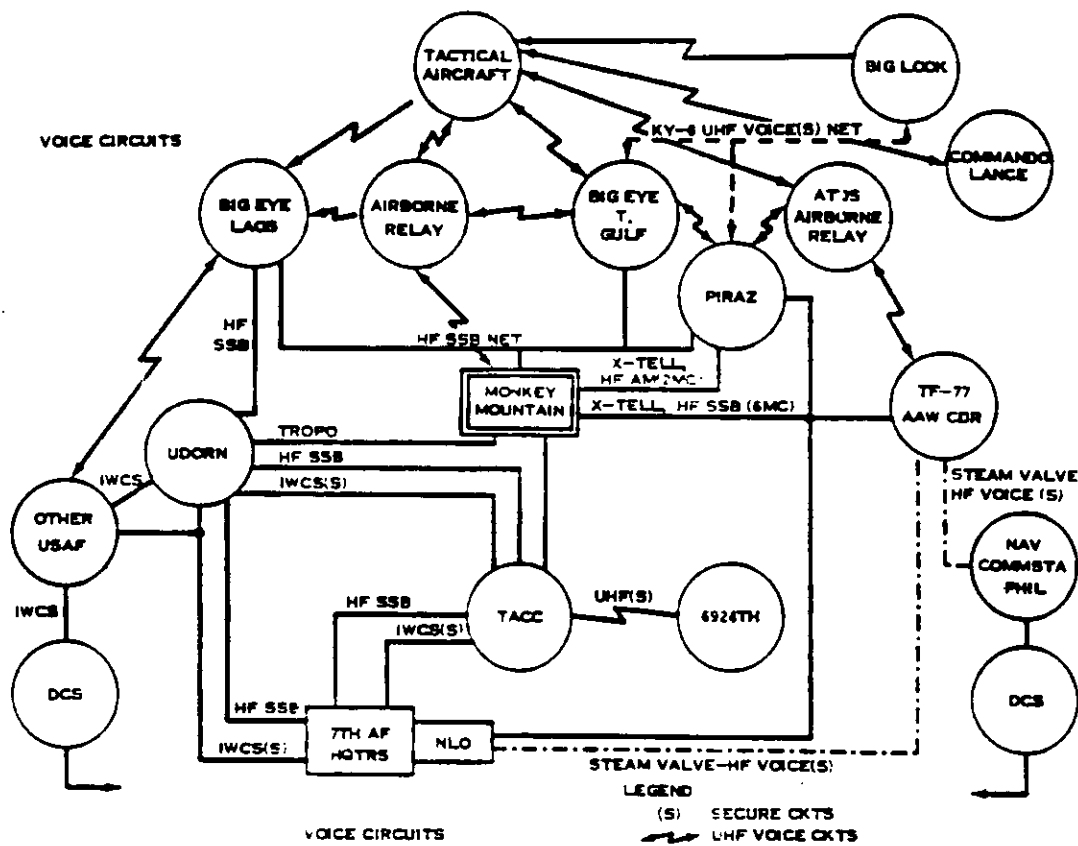

TAB B TO ANNEX D TO APPENDIX G

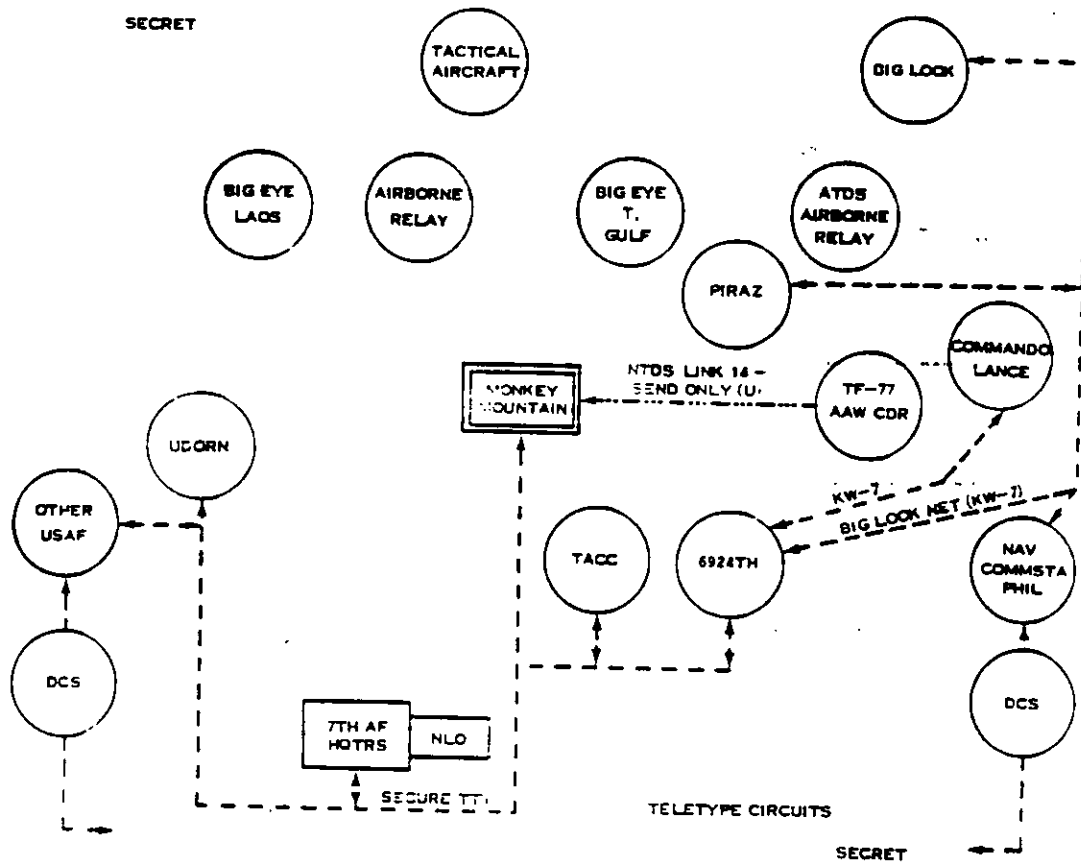

TAB C TO ANNEX D TO APPENDIX G

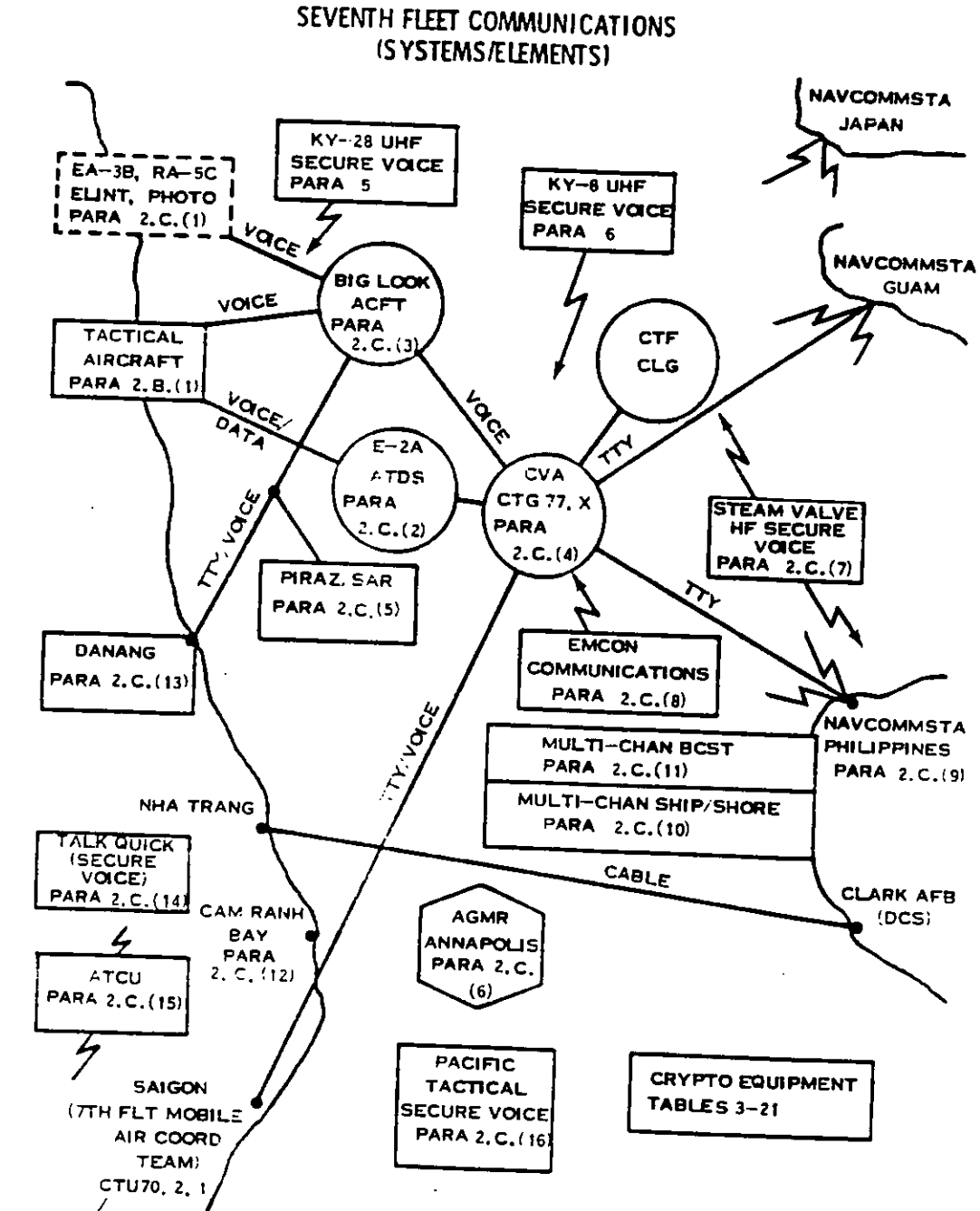

~~SECRET~~

secure voice communications with and among tactical aircraft. Communications analysis indicates such a capability will enhance the effectiveness of strike aircraft. The KY-8, the larger version of the KY-28, is currently used by surface units and larger support aircraft. The KY-28 program is outlined in paragraph 5. The KY-8 program is discussed in paragraph 6. A compilation of additional cryptographic equipment is contained in Tables 19 through 21.

c. Communications Supporting Tactical Air Operations

(1) ELINT/Reconnaissance aircraft communications are provided primarily by UHF equipment. The larger aircraft, including the EA-3B and the EC-121M, have a High-Frequency Single Sideband (HF SSB) capability in addition to UHF and VHF voice. The EC-121M has an HF SSB encrypted (KW-7) teletype capability, permitting netted communications among several subscribers. The use of this capability is discussed in Volume III under the employment of the BIG LOOK aircraft. IAB B to Annex A describes BIG LOOK.

(2) E-2A Airborne Tactical Data System (ATDS) Communications

(a) Extended tactical control of carrier-based strike and AAW aircraft is effected through the ATDS installed in the E-2A aircraft. The aircraft is equipped with advanced air control radar and supporting electronic equipment required to perform this mission. Communications are provided for UHF air-to-air and air-to-surface voice and data transfer. A HF air-to-surface data/voice link is also included. The design of the ASC-88 (communications, navigation, IFF package) permits the E-2A to function as an airborne UHF relay vehicle in addition to its air control mission. The E-2A also has a HF air-to-surface data/voice capability.

(b) The E-2A at present does not have equipment installed for encryption of its data or voice circuits. The KG-23 has been developed for encryption of the air-to-surface

~~SECRET~~

~~SECRET~~

HF data link and delivery of the KG-23 has been accelerated by direction of the Deputy Secretary of Defense. It is currently undergoing operational evaluation, and delivery to fleet units is scheduled during the last quarter FY 67. The requirements for UHF secure voice in the E-2A will be fulfilled with the installation of the KY-28. Delivery of the KY-28 to the Navy is now scheduled to commence during April 1967. However, the aircraft manufacturer indicates KY-28 installation kits for the E-2A will not be available until October 1967. The ASQ-88 must also be modified to operate with the KY-28 for direct UHF communications and to enable relay of the KY-28 encrypted signal. It may be possible to accelerate these modifications and the manufacture of installation kits since a secure voice capability is necessary to realize full utilization of the E-2A/BIG LOOK/BIG EYE potential. BIG LOOK and BIG EYE have KY-8s installed which are compatible with the KY-28. An accelerated schedule is being investigated.

(3) BIG LOOK Aircraft Communications

(a) The Navy has deployed two EC-121M aircraft under the operational control of 7th FLT to provide tactical warning against enemy defenses. Project name "BIG LOOK" has been assigned to this warning effort. The BIG LOOK aircraft are now operating from Danang in direct support of CTF-77 and 7th AF air combat operations. Three additional aircraft will be deployed by June 1967.

(b) [REDACTED]

[REDACTED] Missions are flown on prescribed tracks in the Gulf of Tonkin. Warnings to airborne units are transmitted on UHF guard channels. The BIG LOOK aircraft has one HF A/G encrypted teletype circuit, the function of which is described in Volume III.

NSA

(c) The communication capabilities of the BIG LOOK aircraft are shown in TAB D. BIG LOOK equipment and functions are listed in Table 1.

~~SECRET~~

GD-4

Appendix 3
Appendix 3

~~SECRET~~

TABLE 1

WIG LOOK Communications Equipment/Functions

TYPE	NO	CAPABILITIES	FUNCTION	EMPLOYED	KEY
ARC-87	4	UHF (225-400mc) 1750 Chan	Voice A/A,A/G,A/S UHF Relay	Extend UHF RING Warrior Net SAR	A B C F
ARC-101	1	VHF (116-150mc) 680 Chan	Voice A/A,A/G,A/S	FGS RFP Mission Coord SAR	D F
ARC-38A	1	HF (2-30mc) 14,000 Chan	Voice A/A,A/G,A/S	FGS RFP Mission Coord	D
ARC-119	1	HF (2-30mc) 28,000 Chan	Voice, RATT A/A,A/G,A/S	FGS RFP Mission Coord	D E
EM-7	1	TTY Encoder, 100 WPM	TTY Security A/G,A/S		E
EM-8	2	UHF Secure Voice	A/A,A/G,A/S	Tactical Voice Security	F
TF-264		Teletype			

NSA

NSA

~~SECRET~~

TAB D TO ANNEX D TO APPENDIX G
BIG LOOK COMMUNICATION CAPABILITIES

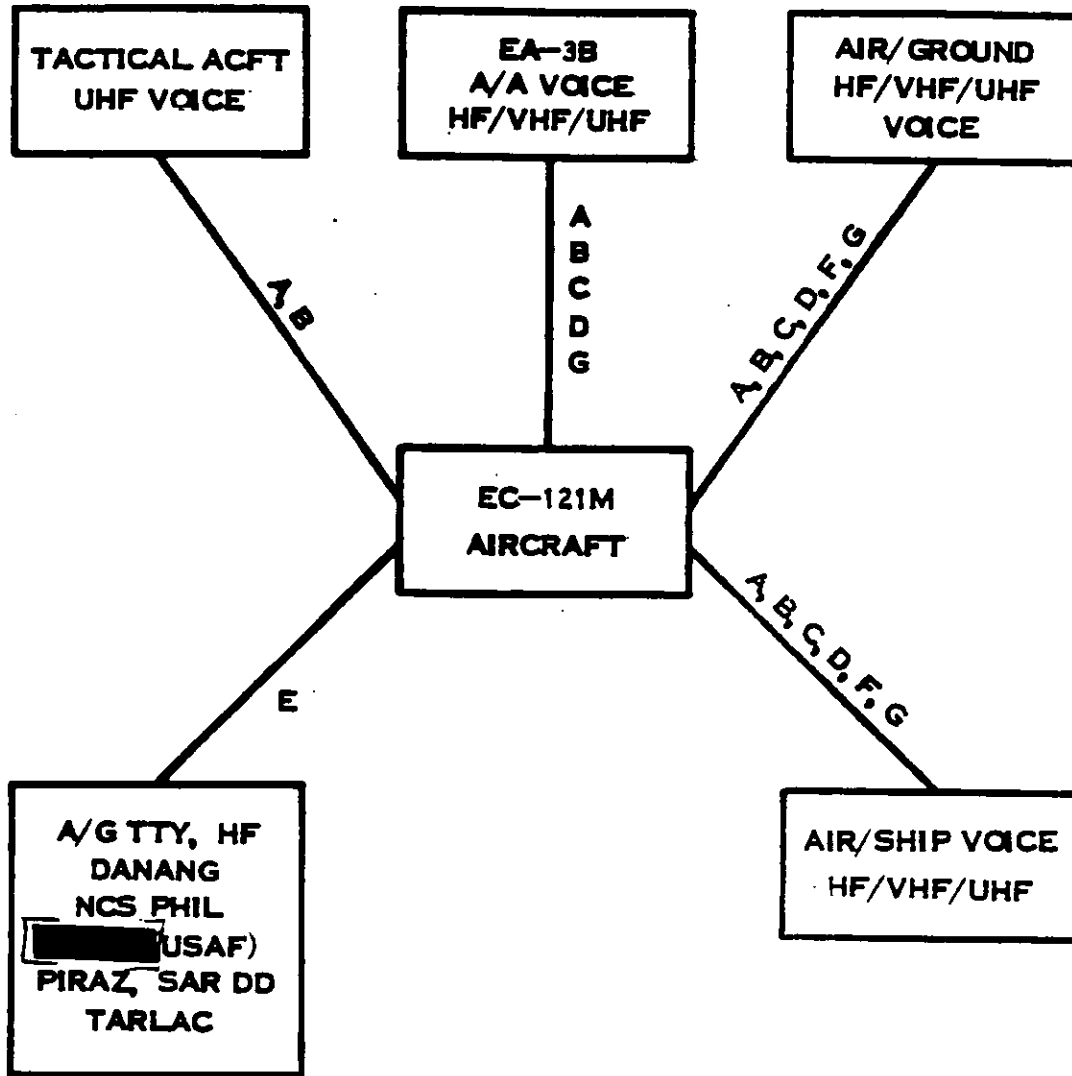

NSA

SEE TABLE
FOR EQUIPMENTS/FUNCTIONS

~~SECRET~~

(4) Aircraft Carrier Communications. Aircraft carriers are equipped to function as mobile air stations and have the communications capability to perform this mission. In this capacity, the carrier is equipped to provide communications incident to air traffic control including land/launch, mission control, fighter intercept control, carrier controlled approach (CCA), and other aspects of air operations. Various HF systems are installed for long range ship to shore and ship to ship communications. Short range communications incident to ship maneuvering and aircraft operations are accommodated by UHF and VHF systems. Capabilities and associated equipment for a typical CVA (USS CONSTELLATION, CVA-64) are shown below and in TAB E. Communications suits for other CVAs will vary but their capabilities will be similar. Terminal equipment (teletypewriters, frequency standards, converters, etc) are not shown.

CVA-64 COMMUNICATIONS EQUIPMENT

Equipment: (CONSTELLATION, CVA-64 shown; Comm Suits will vary in other CVAs)

<u>TYPE</u>	<u>NO.</u>	<u>CAPABILITIES</u>	<u>FUNCTION</u>
WRT-1	2	300-550 kc	Transmit
SRC-14	1	2-30 mc	Transmit
URC-20	4	2-30 mc	Transmit
WRT-6	10	2-30 mc	Transmit
URT-7	2	115-155 mc	Transmit
GRC-1	5	125-400 mc	Transmit
SRC-17	1	225-400 mc	Transmit
SRC-20	4	225-400 mc	Xmit/Receive
SRC-21	3	225-400 mc	Xmit/Receive
TED	10	125-400 mc	Transmit
CRT-5	3	500 and 1000 mc	Transmit

~~SECRET~~

GD-1

Appendix
Appendix

TAB E TO ANNEX D TO APPENDIX G

YANKEE TEAM CVA COMMUNICATIONS

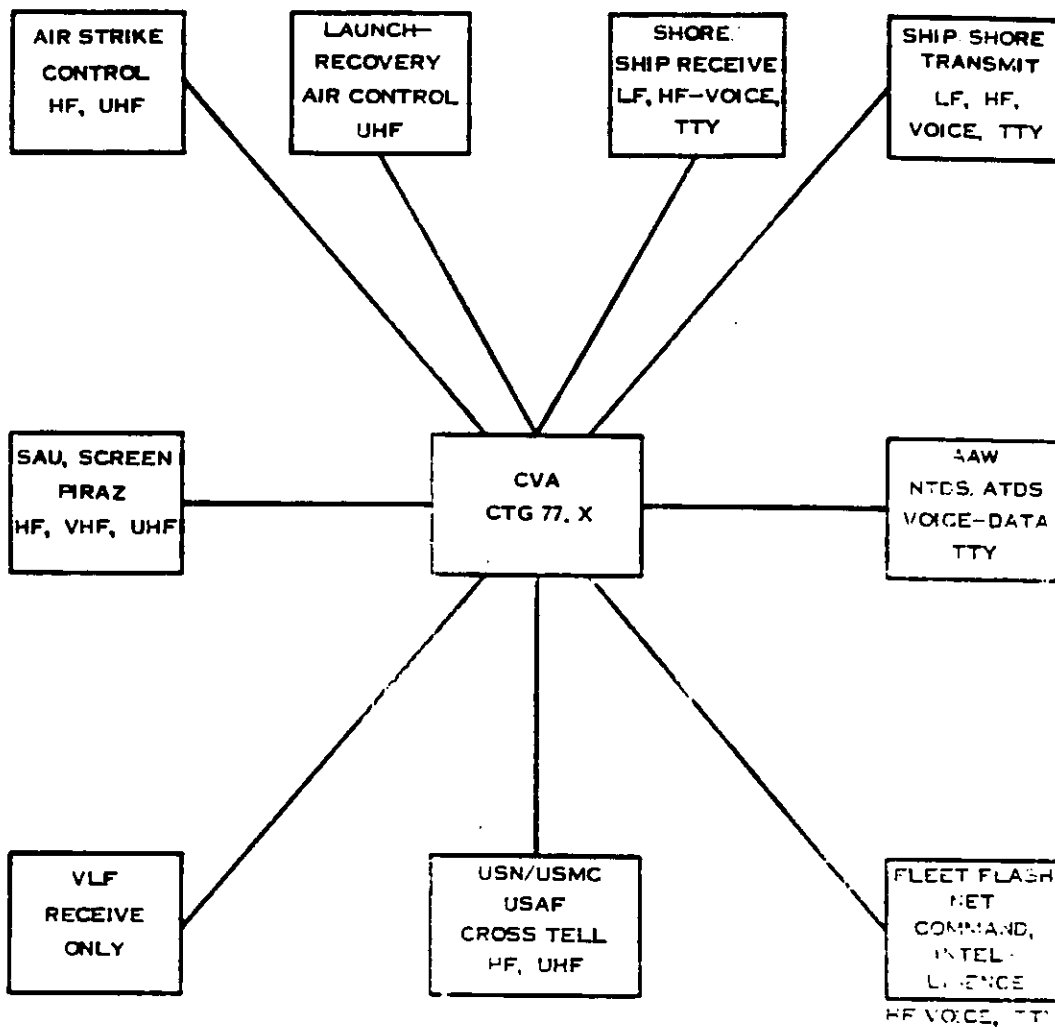

~~SECRET~~

<u>TYPE</u>	<u>NO.</u>	<u>CAPABILITIES</u>	<u>FUNCTION</u>
URC-1	3	121.5 or 243.0 mc	Transmit
BRR-3	1	14-30 kc	Rcvr
SRR-11	9	14-550 kc	Rcvr
R-390	6	500-2250 kc	Rcvr
WRR-2	6	2-30 mc	Rcvr
R-390	29	2-30 mc.	Rcvr
R-1051	6	2-30 mc.	Rcvr
R-274B	1	30-260 mc	Rcvr
VRR-27	2	115-156 mc	Rcvr
VRR-35	15	225-400 mc	Rcvr
UCC-1	2	TTY Multiplex Terminal	
TT-321	1	FAX	Xmit
UGC-1	8	NTDS Terminal	NTDS
USQ-20 (v)	1	NTDS Terminal	
HL-1,2	3	TTY Off Line Crypto	Encrypt/Decrypt
KW-7	6	TTY On Line Crypto	Encrypt/Decrypt
KW-26	4	TTY On Line Crypto	Transmission Security Encrypt/Decrypt
KNR-37	6	TTY On Line Crypto	Multi-Channel BCST Decryption
KG-14	7	Key Generator	Multi-Channel BCST Decryption

(F) PIRAZ/SAR Communications

(a) Specific ships have been assigned by the Fleet Commander to CTF-77 for PIRAZ, SAR and AAW

~~SECRET~~

GD-1

Annex D to
Appendix G

~~SECRET~~

duty in YANKEE TEAM Operations. All PIRAZ ships are configured for NTDS operation. The SRC-16 is the four channel HF transmitter-receiver used for NTDS transmission/reception. Usually only two channels are used for NTDS application and the remaining channels can perform other HF communications functions. Ships designated for PIRAZ/SAR/AAW use are listed below. Communications suits have been increased to provide the indicated capabilities. In cases where equipment is not available, cabling and foundations are being installed and equipment is rotated to the units in the forward area.

(b) PIRAZ

1. Ships Designated for PIRAZ Duty:

Ship	To CTF-77
CGM-9 - LONGBEACH	Mar 66
CG-11 - CHICAGO	Jun 68
DLG-20 - BELNAP	Oct 67
DLG-20 - WAINWRIGHT	May 67
ELG-33 - FOX	Jun 67
ELG-11 - MAHAN	Dec 66
ELG-30 - BIDDLE	Apr 68

Each ship will have the following communications capabilities for PIRAZ duty:

- a. 2 UHF Secure Com Devices: (KY-8)
- b. 2 HF Transmitters (8 for CG, 6 for DLG)
- c. 2 UHF Transmitters, including 1 (also power quick change unit (PAC-20, 21))
- d. 1 UHF Receiver
- e. Class "A" Antenna (6 cyrc unit)

~~SECRET~~

~~SECRET~~

f. Multi-channel broadcast reception equipment, channels 1-7, Type "N" Crypto system.

g. SRC-16 - NTDS terminal

(c) SAR/AAW

1. Ships designated for SAR/AAW Duty:

<u>Ship</u>	<u>To CTF Control</u>
BUCHANAN	Oct-Dec 66
PREBLE	Oct-Dec 66
H.B. WILSON	Oct-Dec 66
WADDELL	Oct-Dec 66
HOEL	Oct-Dec 66
BERKLEY	Oct-Dec 66
GOLDSEBROUGH	Oct-Dec 66
STODDERE	Oct-Dec 66
DAHLGREN	Mar 67
W.B. PRATT	Jul 67
COONTE	Dec 67
DEWEE	Dec 67
KING	Jan 68

2. Each ship will have the following communications capability for SAR/AAW duty:

- a. 1 UHF Secure Voice Device (KY-8)
- b. 4 HF transmitters
- c. 7 UHF transmitters (4 quick shift)
- d. 2 UHF receivers

~~SECRET~~

CE-8

Annex D to
Appendix G

TAB F TO ANNEX D TO APPENDIX G

AGMR CAPABILITIES

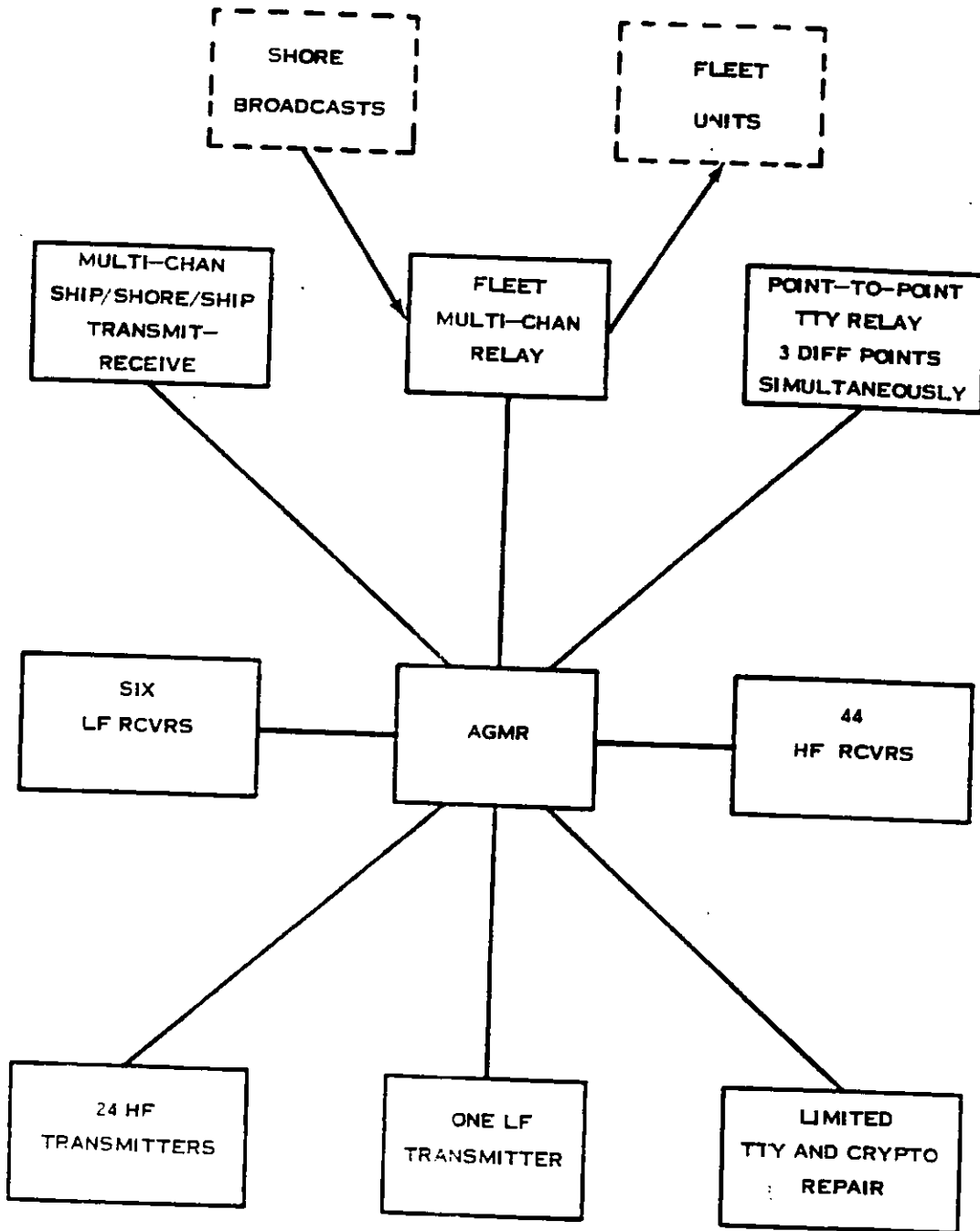

~~SECRET~~

3. During initial phases of the PIRAZ/
SAR/AAW concept, equipment pools have been
established at Subic Bay. Equipment in
pool:

- a. 3 URC HF transmitter/receivers
- b. 3 SRA-22
- c. 3 GRC-27 UHF transmitter/receivers

(6) AGMR (US Navy Communications Major Relay Ships),
USS ANNAPOLIS and USS ARLINGTON

(a) The USS ANNAPOLIS (AGMR-1) and the USS ARLINGTON (AGMR-2) are converted aircraft carriers modified to operate as major communication relay stations. Each has the capability of performing the services of a naval shore communication station. Primarily, the AGMRs provide mobile communication facilities for command and control of fleet operations in areas where shore stations do not exist or are inadequate. The ANNAPOLIS became operational in June 1964 and has been on station in the South China Sea since November 1965. The ARLINGTON is currently undergoing fleet acceptance trials and will be deployed in support of Southeast Asia operations by September 1967. Both ships can accept helos for operational supply support. The ANNAPOLIS has been in the Yokosuka, Japan shipyard undergoing repairs but is expected to be back on station during March 1967. While the ANNAPOLIS has been operating off South Vietnam, it will begin operations further north in support of WINKEE TEAM operations upon completion of current repairs.

(b) Afloat units operating in WESTPAC have been unanimous in their praise of the AGMR services indicating the important role of the AGMR in Southeast Asia naval operations. The ANNAPOLIS has a crew of 750 officers and men while the ARLINGTON has a crew of about 900. They both have similar capabilities with the ARLINGTON's design reflecting "lessons learned" with the ANNAPOLIS. (See TAB F).

~~SECRET~~

GD-9

Annex D to
Appendix G

(7) STEAM VALVE Program

(a) Project STEAM VALVE was initiated during 1965 in response to an urgent CINCPACFLT requirement for a HF secure voice capability to coordinate 7th FLT air operations. STEAM VALVE, an interim program, is installed in the 7th FLT flagship, attack carriers, specified cruisers and at supporting shore commands indicated herein. Fifteen complete systems were initially procured; six for shore terminations and nine for installation in selected ships. Subsequently, the shipboard equipment was rotated to YANKEE TEAM units with a total of twenty-three ships configured to accommodate STEAM VALVE equipment. The initial installations provided subscriber to subscriber secure voice but was not capable of being netted. A netting feature is currently being incorporated.

(b) Command Subscribers

1. CINCPACFLT Headquarters
2. COMSEVENTHFLT Flagship
3. YANKEE TEAM carriers/cruisers
4. COMNAVPHIL
5. COMNAVFORJAPAN
6. COMSEVENTHFLT Detachment "C" (TAN SON NHUT), for coordination with 7th AF Commands
7. Chief of Naval Operations (Flag Plot)

(c) Ships which have provisions for STEAM VALVE or are planned to receive installations:

1966

USS OKLAHOMA CITY	CLG 5
USS ORISKANY	CVA 34
USS INDEPENDENCE	CVA 62
*USS TICONDEROGA	CVA 14

~~SECRET~~

*USS HANCOCK	CVA 19
*USS BONNE HOMME RICHARD	CVA 31
USS RANGER	CVA 61
*USS KITTY HAWK	CVA 63
USS PINE ISLAND	AV 12

1967

USS INTREPID	CVS 11
*USS ENTERPRISE	CVA(N) 65
*USS CONSTELLATION	CVA 64
*USS CORAL SEA	CVA 43
USS MIDWAY	CVA 41
USS ESTES	AGC 12
USS ELDORADO	AGC 11
USS MT MCKINLEY	AGC 7
*USS PROVIDENCE	CLG 6
USS CANBERRA	CAG 2
USS TOPEKA	CLG 8
USS GALVESTON	CLG 3
*USS F. D. ROOSEVELT	CVA 42
USS FORRESTAL	CVA 59

*Currently have system on-board

(d) STEAM VALVE Equipment

1. 1 KY-537 VOCODER
2. Secure System Controller
3. System Isolator

~~SECRET~~

GD-11

Annex D to
Appendix C

4. 1 TSEC/KG-13 Crypto Device
5. 1 FYC-9 HF Modem (ship or shore)
6. 1 FYC-9 HF Modem (shore only)

The foregoing equipment occupies approximately two and one half standard 19 inch racks.

(e) Comments

1. The STEAM VALVE program was established as an interim system. However, an additional 29 units are now being procured to expand the program. Four of these systems will be used by the USMC in communication vans, the remainder will be utilized in selected ships, shore stations and for technical schools.

2. CINCPAC has submitted to the Joint Chiefs of Staff a statement of requirements for tactical narrowband secure voice equipment. Based on this submission, the Secretary of Defense has directed the Joint Chiefs of Staff to evaluate CINCPAC requirements and submit recommendations by 1 March 1967. The status of the resulting study is discussed in paragraph 2b(16) of this Annex under Narrowband Secure Voice Requirements.

(8) Operations While Employing Electronic Emission Control (EMCON) for Communication Deception or Radiation Silence

(a) Control of electronic emissions in force operations can be divided into two separate areas: (1) those radiations emanating from electronic sources such as radar, IFF and various weapons guidance systems and (2) those radiations incident to communications. The former operate at frequencies in the UHF band (300-3000mc) and higher where radiations are limited approximately to line of sight, a function of the height of both the radiating source and the detection device, and the power of the transmitting element. The radio distance to effective horizon is given with a good approximation by:

$$d = \sqrt{2h}$$

~~SECRET~~

where: h = height in feet above sea level

d = radio distance to effective horizon in miles, when h is very small compared to the earth's radius

Accordingly, UHF radiations are susceptible to detection, jamming and deception at relatively short distances only. Enemy threats and US countermeasures associated with these functions are addressed elsewhere in this report in the Weapons and Munitions section. Conversely, radiations incident to long range communications upon which the CTF is dependent (HF, 3 to 30mc, and lower) will propagate up to several thousand miles. Information content is protected cryptographically; however, the location of the source of radiation can be determined accurately from these distances using direction finding (DF) techniques.

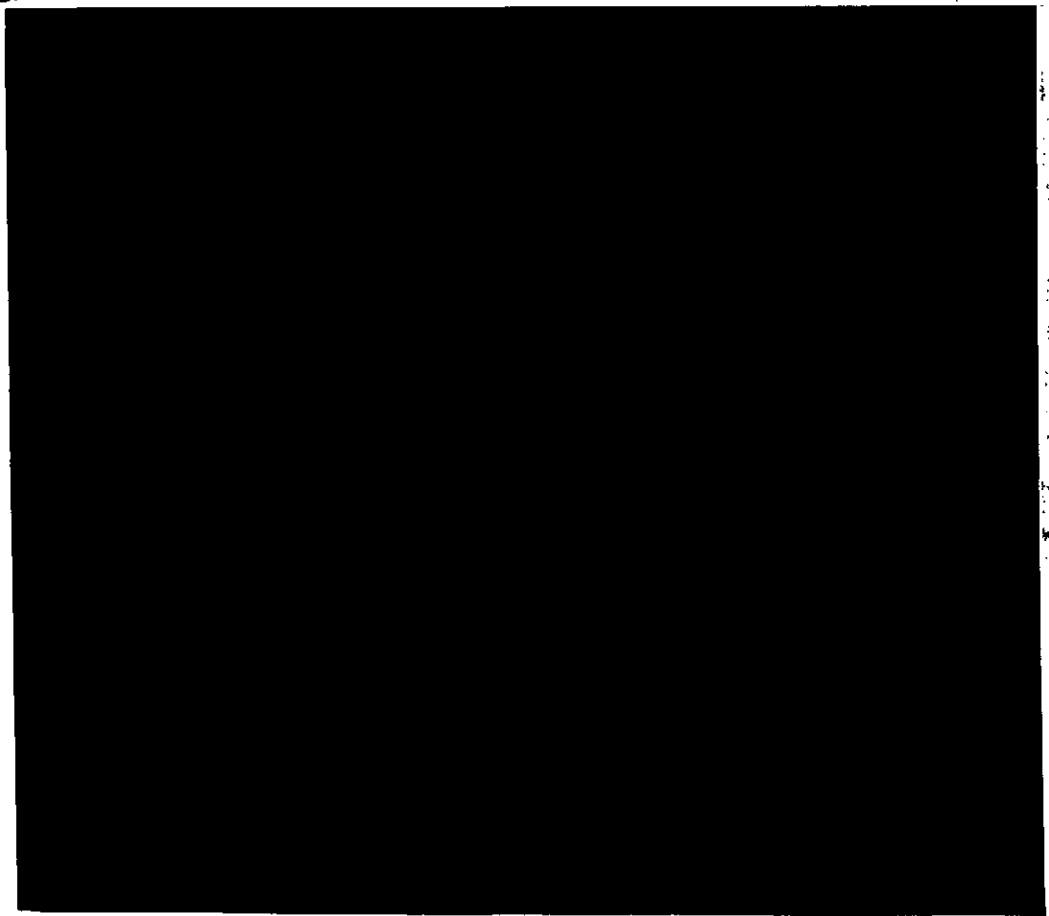

~~SECRET~~

GD-13

Appendix D to
Appendix G

~~SECRET~~

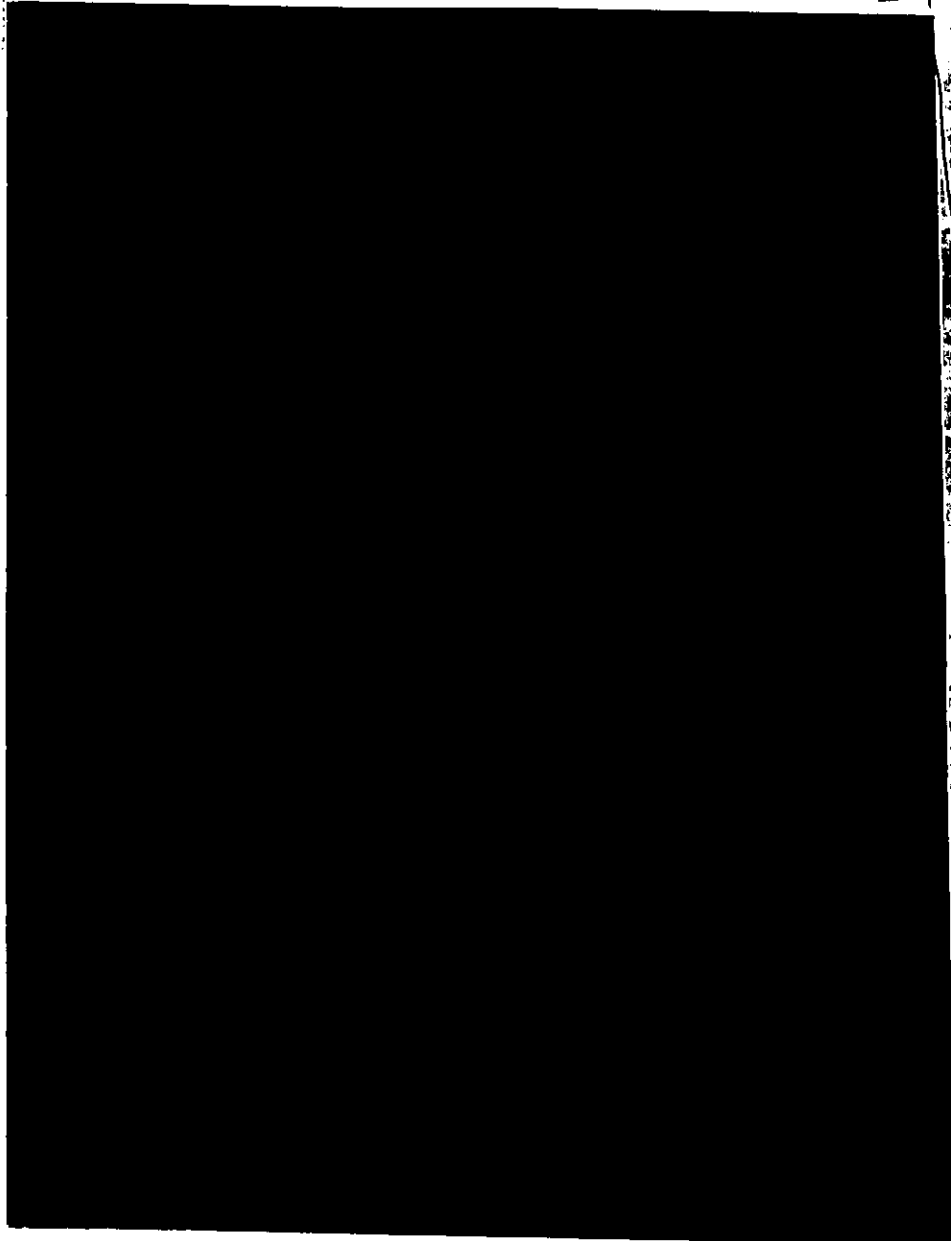

(c) The Satellite Communications (SATCOM) program shows promise of partially meeting NSM requirements for EMCON communications. The Navy is pursuing this development as a part of its shipboard SATCOM program.

~~SECRET~~

GD-14 -

Index D to
Appendix C

TAB G TO ANNEX E TO APPENDIX G

NAVCOMMSTA PHILIPPINES CAPABILITIES

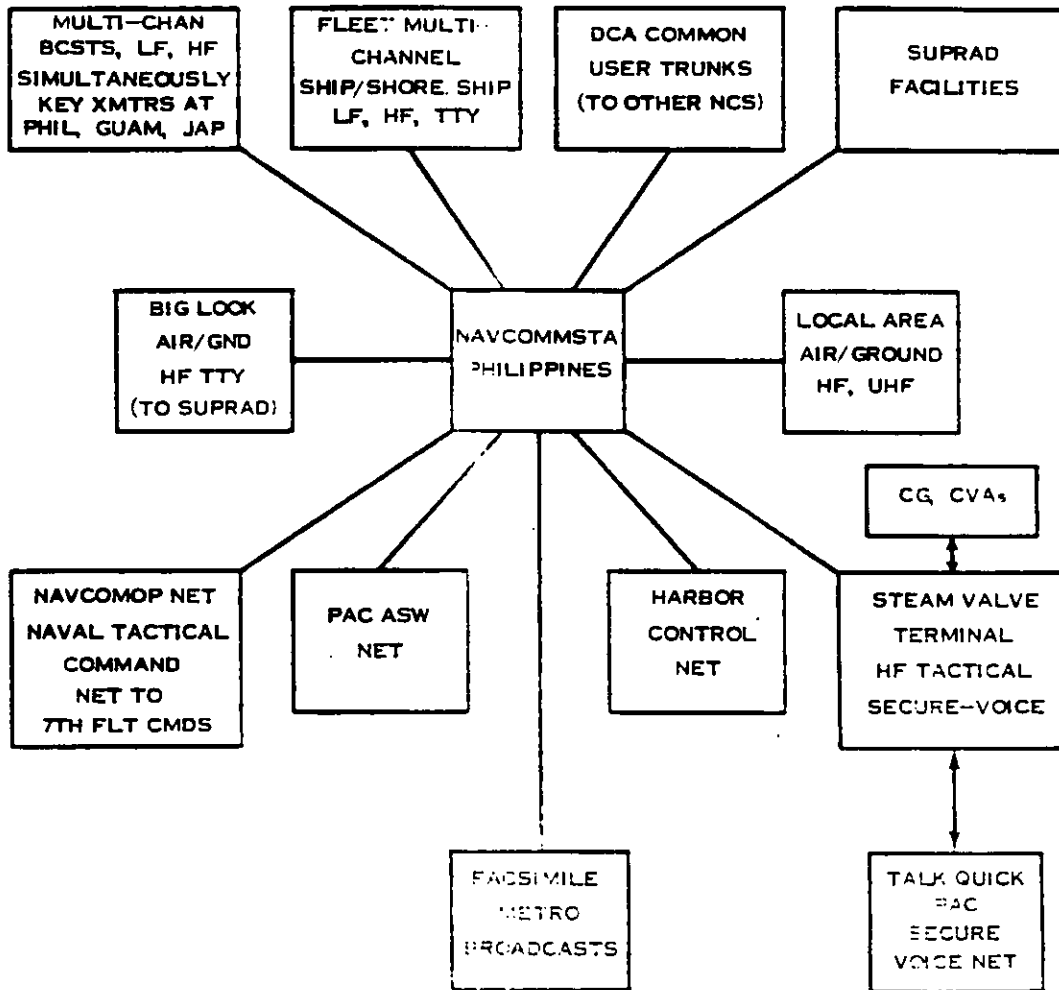

~~CONFIDENTIAL~~

TAB H TO ANNEX D TO APPENDIX G

MULTI-CHANNEL SHIP-SHORE-SHIP RADIO TELETYPEWRITER ORGANIZATION PLAN

Traffic Channel	Assignment	Freq. (CPS)	INTERIO ASSIGNMENT		OUTSIDE ASSIGNMENT		Share Station/AGNR Termination
			Crypto Coverage	Shipboard Term	Crypto Coverage	Shipboard Term	
A	Order Wire	125 785	AW-26	Secure Teletype-writer Room	AW-7	Secure Teletype-writer Room	Facility control
B	NAVCONOPNET	505 1455	AW-7	Secure Teletype-writer Room	AW-7	Secure Teletype-writer Room	Fleet center (TS area)
C	Command Control	765 2125	AW-26	Crypto	AW-26	Crypto	Facility control for patch through
D	Ship Shore	935 2245	AW-26	Secure Teletype-writer Room	AW-7	Secure Teletype-writer Room	Facility control; dist. center with patch through shipboard from facility control
E	Command Control	1105 2165	AW-7	Secure Teletype-writer Room	AW-7	Secure Teletype-writer Room	Facility control for patch through
F	Command Control	1275 2635	AW-7	Secure Teletype-writer Room	AW-7	Secure Teletype-writer Room	Facility control for patch through
G	CRITICOM	1115 2805	AW-26	SI PRAD spaces	AW-26	SI PRAD spaces	Facility control for patch through
H	Operations Assignment	1615 2975	AW-7	Secure Teletype-writer Room	AW-7	Secure Teletype-writer Room	Facility control; dist. center with patch through shipboard from facility control

Note: In installations where facilities are not available, control stations shall be established in accordance with the equipment organization plan.

~~CONFIDENTIAL~~

GDH-1

Tab H to Annex D to Appendix G

TAB I TO ANNEX D TO APPENDIX G

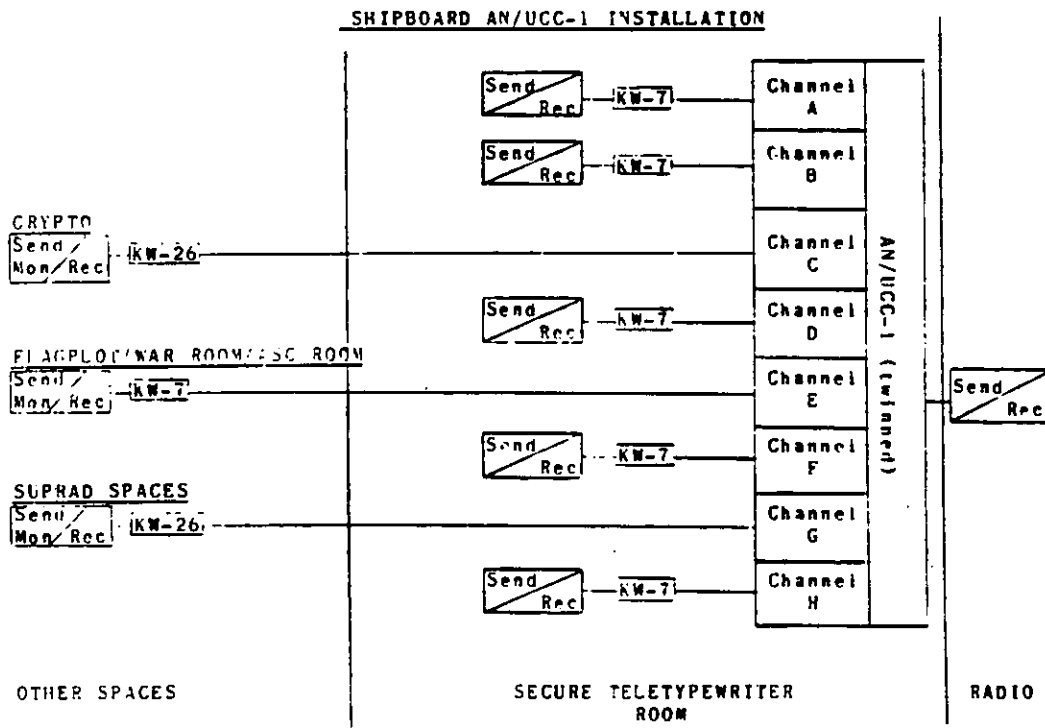

~~CONFIDENTIAL~~

TAB J TO ANNEX D TO APPENDIX G

MULTI-CHANNEL SHIP TO SHORE
CIRCUIT/CHANNEL PLAN BY SHIP TYPE

<u>TYPE SHIP</u>	<u>A</u>	<u>B</u>	<u>C</u>	<u>D</u>	<u>E</u>	<u>F</u>	<u>G</u>	<u>H</u>
AD(FF)	X	X	X	X				
AGC*	X	X	X	X	X	X	X	X
AGMR**	X	X	X	X	X	X	X	X
AVP	X	X	X	X				
AR(FF)	X	X	X	X				
AS(FF)	X	X	X	X				
AS(FBM)	X	X	X	X	X			
CA(FFF)*	X	X	X	X	X	X	X	X
CAG/CG/CGN	X	X	X	X				
CC(FFF)***	X	X	X	X	X	X	X	X
CLG(non-flag)	X	X	X	X				
CLG(FFF)**	X	X	X	X	X	X	X	X
CVA/CVA(N)	X	X	X	X	X		X	
DVE	X	X	X	X				
ACTR	X	X	X	X			X	

Note: * - Two full systems
** - Six full systems
*** - Four full systems

Ships with less than eight channels allocated, may as operational conditions dictate, be issued equipment to terminate additional channels.

~~CONFIDENTIAL~~

GDM-1

Tab J to
Annex D to
Appendix G

TAB K TO ANNEX D TO APPENDIX G

CAM RANH BAY COMMUNICATION FUNCTIONS
(NAVY)

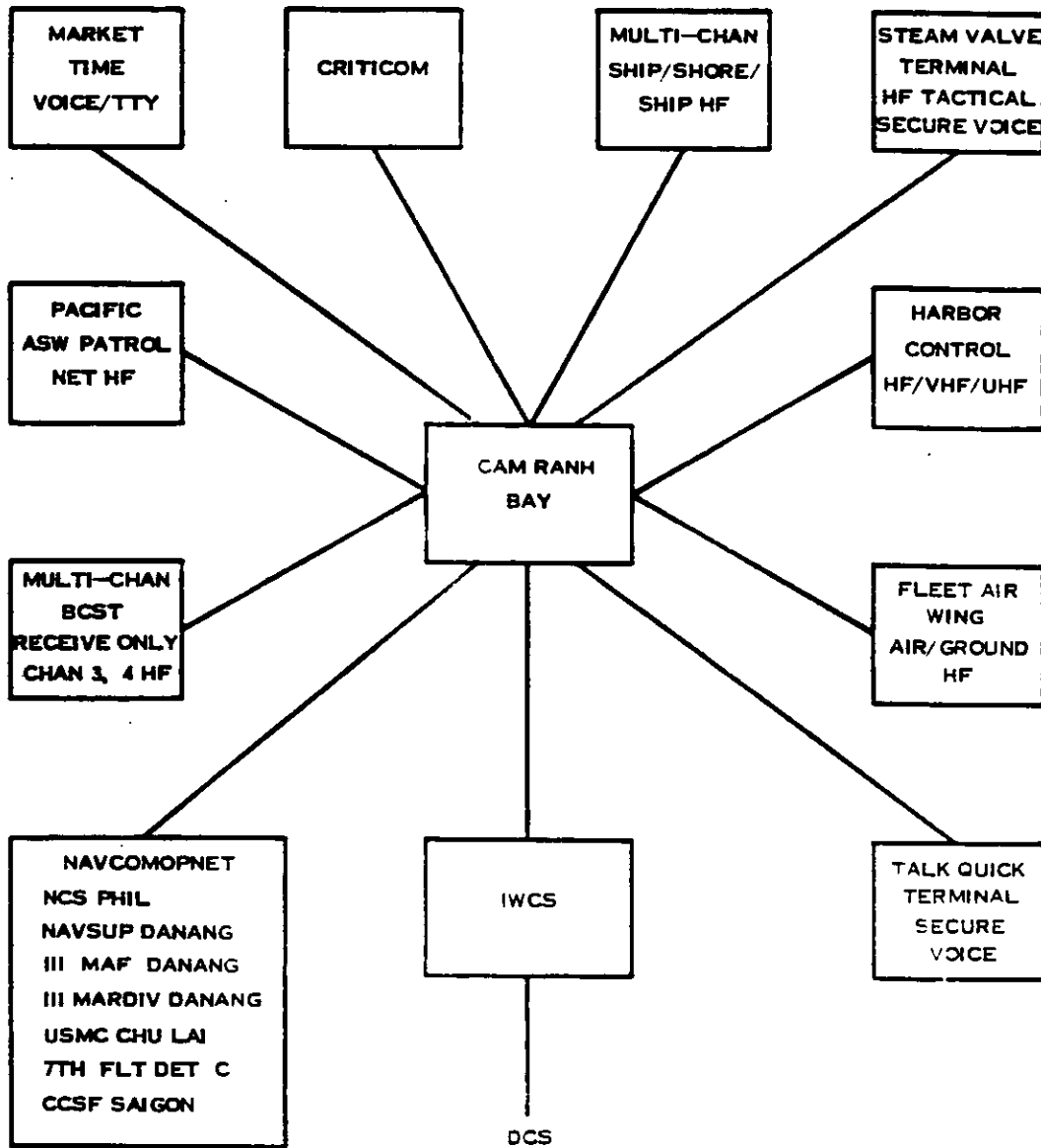

TAB L TO ANNEX D TO APPENDIX G

DANANG COMMUNICATION FUNCTIONS
(NAVY)

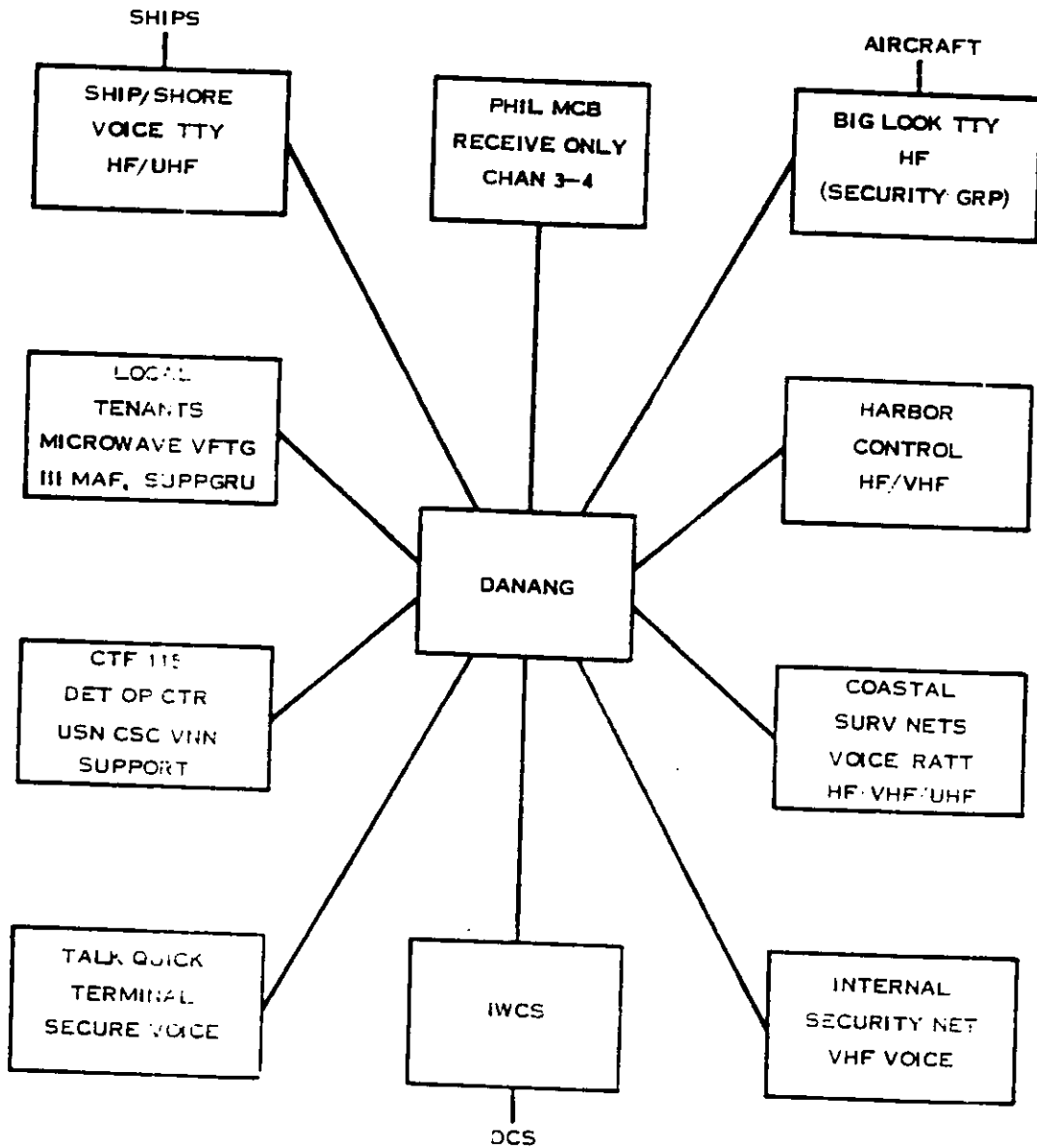

~~CONFIDENTIAL~~

TAB M TO ANNEX D TO APPENDIX G

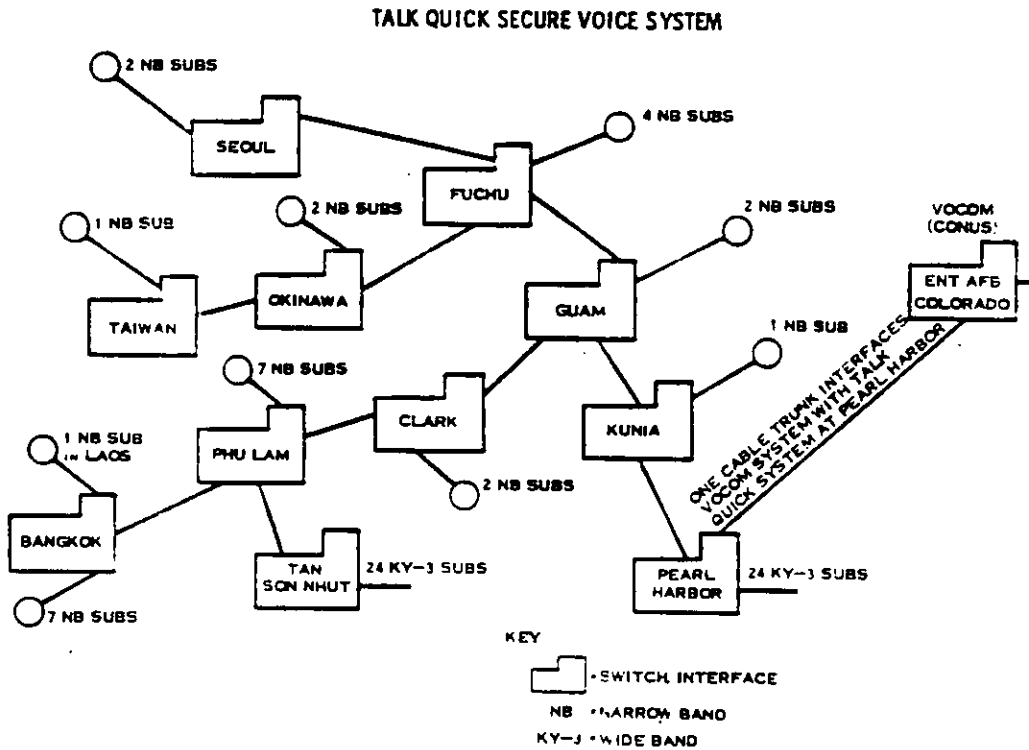

~~CONFIDENTIAL~~

3210-1

Tab M to
Annex D to
appendix G

~~CONFIDENTIAL~~

TAB N TO ANNEX D TO APPENDIX G

AIR TRANSPORTABLE COMMUNICATIONS UNIT
CAPABILITIES

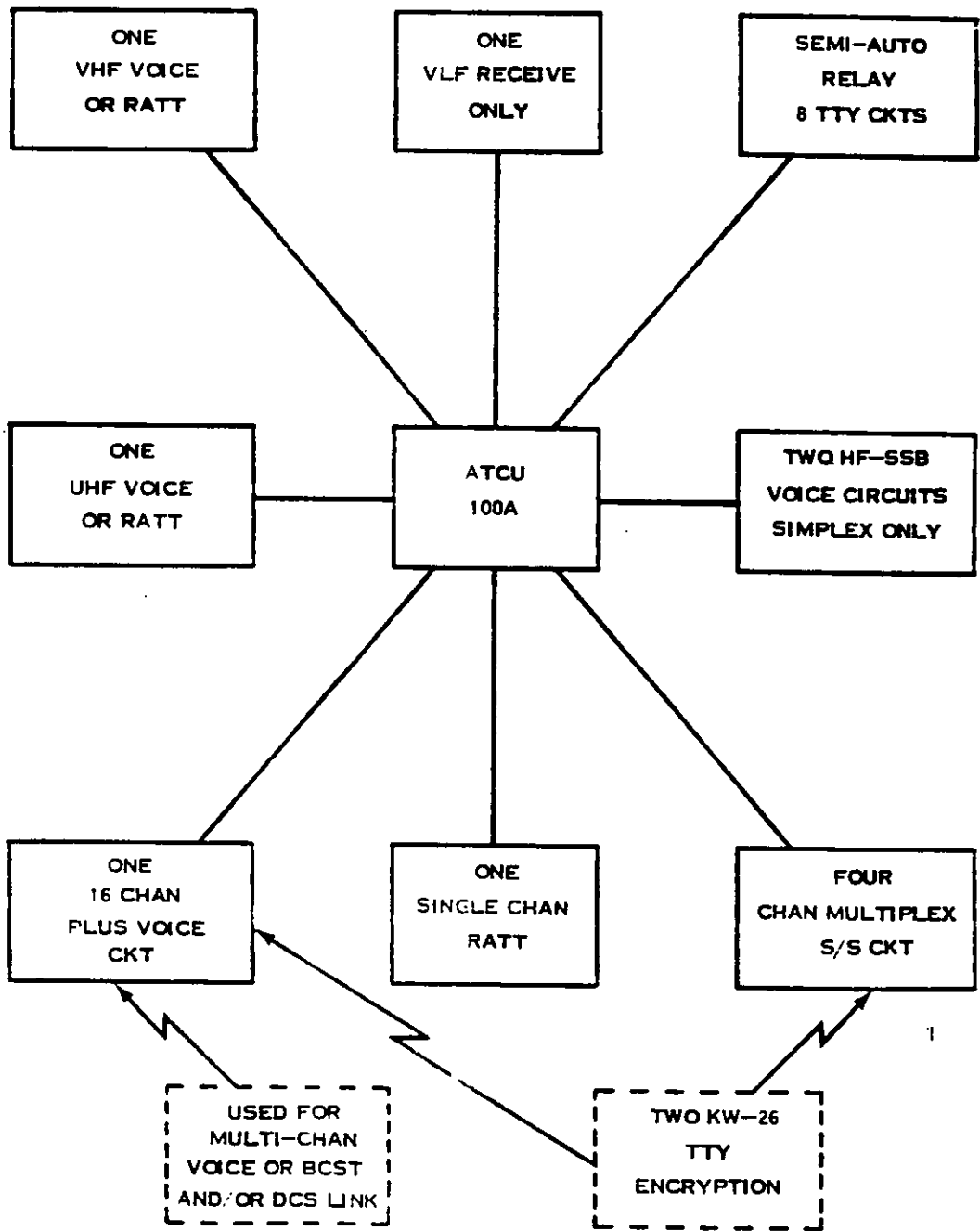

~~CONFIDENTIAL~~

GDN-1

Tab N to
Annex D to
Appendix G

~~SECRET~~

(9) Naval Shore Communications Station (NAVCOMMSTA)

(a) Tab G shows the circuits and functions of Naval Communications Station Philippines which is the Southeast Asia Communication Area Master Station controlling naval communications in the area. The area NAVCOMMSTAs provide communications support to all naval units operating within the area of the NAVCOMMSTAs communications coverage. Additionally, the NAVCOMMSTA provides the fleet access to the common user facilities of the Defense Communication System. Interface at NAVCOMMSTA Philippines with the USAF and USA is accomplished via common user transfer circuits with Clark AFB and Fuchu. Limited air operations voice networks exist between Cubi and Clark.

(b) The entire effort of NAVCOMMSTA Philippines is directed toward 7th FLI operations. Of particular interest is an encrypted air/ground teletype circuit with the BIG LOOK aircraft with other YANKEE TEAM units on the net. This net provides a direct intelligence channel to the Supplementary Radio (SUPRAD) activities at NAVCOMMSTA Philippines and Danang. Further distribution is accomplished via the multichannel broadcast (channel 6), ship/shore and common user facilities available at the NAVCOMMSTA. Currently, channel six on the multichannel broadcast, is experiencing backlogs of high priority tactical traffic. CINCPACFLT has recommended the present channel six be untwinned to provide additional capacity. Additionally, it has been recommended a specific channel in multichannel ship-to-ship circuit be dedicated to a DVA netted operation. These actions will permit more rapid exchange of tactical intelligence among COM 7th FLI units engaged in YANKEE TEAM operations. The CINCPACFLT recommendations are being considered.

~~SECRET~~

~~SECRET~~

(10) Fleet Multichannel Radio Teletypewriter
Ship and Shore-to-Ship (MCS/S) Communications

(a) The single channel teletypewriter circuits previously used for ship and shore-to-ship communications proved to be inadequate for the amount of traffic required for the control of widely dispersed mobile units. The MCS/S concept was formulated to provide Naval Communications a means of increasing the circuit capacity of ship-to-shore and shore-to-ship teletypewriter systems without increasing transmitter, receiver, and antenna requirements. The MCS/S equipment is being installed on selected ships.

(b) Each channel of the MCS/S system will have cryptographic security provided by KW-26 or KW-7 equipments. A capability for direct patch-through at naval shore station and in communication ship terminals for duplex channels is provided as dictated by operational requirements. MCS/S channelization will be in accordance with TABs H and I. Special privacy requirements will be satisfied by locating the terminal cryptographic equipment in the operating space originating or receiving special traffic as shown in TAB I. The KW-26 is normally used on channels requiring traffic flow security or subscriber to subscriber termination. The KW-7 is used on the remaining channels. Off-line encryption will remain as an alternate means of end-to-end encryption of special privacy when intervening relay points cannot be bypassed. The MCS/S circuit/channel plan by ship type is shown in TAB J. This program is about 75 percent complete. Ships deploying to WESTPAC have had priority in receiving MCS/S installations.

(c) The introduction of the MCS/S system has greatly enhanced the traffic handling capabilities of afloat units. Further enhancement of this capability is expected as ancillary equipment employing error detection and correction techniques and automatic switching and message distribution features are incorporated. Addition of this equipment is currently being planned.

~~SECRET~~

(11) Fleet Multichannel Radio Teletypewriter
Broadcast Plan (MCB)

(a) The MCB permits the broadcast and reception of radioteletype signals. Eight discrete 100 WPM channels are transmitted on one SSB frequency from shore naval communication stations. Only aircraft carriers, cruisers, and other selected major ships are equipped to receive all eight channels. Other ships are equipped to receive a lesser number of channels as a function of mission. The MCB uses a combination of KW-37 and KG-14 crypto devices for security. Up to four KG-14 can be operated with each KW-37 (the KW-37 provides the required timing signals to the KG-14s).

(b) The MCB is now operational in the Pacific. World-wide coverage is scheduled to commence by FY 69. Not all ships have been equipped but those which are scheduled to receive MCB equipment are being outfitted as they are overhauled. All major ships operating in the Pacific have a MCB reception capability.

(c) Current Pacific MCB channelization is as follows:

<u>Channel</u>	<u>Functional Use</u>
1	ASW - may be otherwise used if required
2	SPECIAL PURPOSE - Intelligence
3	COMMON USER
4	U.S. FLEET BROADCAST
5	ASC - Atomic Strike Circuit for CVA and Flagships
6	OPERATIONAL INTELLIGENCE
7	FLEET COMMAND - Selected operation commanders
8	METEOROLOGICAL BROADCAST

(d) Installation of Multichannel Broadcast Equipment by Ship Type

1. Equipment will be installed in ship types in the general priority indicated below. Installation will be keyed to the overhaul cycle of individual ships. Priority will be altered as dictated by changing requirements or missions of individual ships.

- a. AGMR
- b. CLG(FF)
- c. CA(FF)
- d. CVA/CVAN
- e. CVS
- f. AGC/AVP/AV
- g. CGC
- h. CG/CGN
- i. CAG
- j. CLG/CA (non-flag)
- k. AO(F)/APA(F)/LFD(F)/LPH(F)
- l. AD
- m. DEG/DL/DLG/DLG(N)
- n. AE/AOE
- o. AR(F)/AS(FBM)
- p. LFS/LPD (non-flag)
- q. AGTR
- r. DDG

- s. DD/DDR/DE
- t. LPH/LPV/MCS
- u. APA/AKA/APD/LSD/LST
- v. MSO/AO/AOR/AGDE/AK(FBM)
- w. DER
- x. AVB/AF/AR/AG/LSM/AG(RDT&E)
- y. ARS/ARSD/ARL/ARG/ARC/AKS/AKL/ASR/ATA/ATF/ATS/ADG/AG/AGS/AVM
- z. AGSC/AGSL

(12) Cam Ranh Bay Communications (Navv). The communication facilities at Cam Ranh Bay will provide communication support to fleet operations in Southeast Asia including fleet air and coastal surveillance force operations. In addition, message center functions for naval activities in the Cam Ranh Bay area and Naval Command Operational Network (NAVCOMOPNET) torn tape relay functions for Southeast Asia tributaries will be performed. In-country communications will utilize the facilities of the IWCS. The Cam Ranh Bay communications facilities are scheduled to be operational by 15 June 67. The Cam Ranh Bay communication functions are shown in TAB K.

(13) US Naval Communications - Danang. Communication facilities for COMNAVSUPACT Danang and NAVSUPACT Danang detachments at Chu Lai and Phu Bai will provide communications in support of local fleet, MSTS and harbor operations together with on-base and local logistic communications. Message center functions will also be performed. In-country communications will utilize the facilities of the DCS Integrated Wideband Communication System (IWCS) which is under the cognizance of the US Army Strategic Communications Command (USASCC). The naval communications facilities are scheduled to be operational by 15 Jul 67. The communication functions of the Naval Communication Facility at Danang are shown in TAB L.

~~SECRET~~

(14) Pacific Area Secure Voice System (TALK QUICK)
and DCS Automatic Secure Voice Communications System
(AUTOSEVOCOM)

(a) AUTOSEVOCOM is the unclassified title for the DCS Automatic Secure Voice Communications System currently being developed. This system will provide users with an automatically switched secure voice capability and will be authorized for classified conversations up to and including TOP SECRET. When the system is authorized for the transmission of Special Intelligence information, a separate authentication system will be required. Person-to-person and conference calls may be conducted using this system.

(b) TALK QUICK is the manual interim Pacific Area Secure Voice System serving the requirements of the Department of Defense and other authorized users of the Defense Communications System (DCS) in the Pacific, Far East, and Southeast Asia area. While TALK QUICK will be an integral part of the AUTOSEVOCOM network, it is presently functioning as a manually (operator assisted) operated system. It facilitates both wide band (50 kc) and narrow band (3 kc) subscribers, using wide band manually operated switches. These switches serve wide band subscribers on a local area basis in the manner of a PEA. Narrow band subscribers are individual terminals and may be interconnected through Joint Overseas Switchboards. TALK QUICK interfaces with VOCOM (COMSEC Secure Voice System, WCAF) at Pearl Harbor. WCAF shows TALK QUICK as it now exists using dedicated point to point circuits and the Southeast Asia INCS. Additions or deletions from the system must be validated by CINCPAC for approval by the Joint Chiefs of Staff.

(c) It is planned to interface SILAM VALVE (USN Tactical Narrow Band Secure Voice System) with TALK QUICK at Manila, Guam, Clark AFB, and Fuchu, Japan. Cam Ranh Bay will also have a TALK QUICK terminal when the Naval Communication Facility becomes operational in June 1967. Initially a TALK QUICK SILAM VALVE interface will not exist at Cam Ranh Bay but plans for this capability are being formulated.

~~SECRET~~

~~SECRET~~

(d) Vietnam TALK QUICK/Secure Voice
Subscribers:

1. Bien Hoa AB (TUOC)
2. Can Tho (Sr Advisor IV Corps)
3. Da Nang (CG III MAF)
4. Danang AB (TUOC)
5. Long Binh (CG II TFORCEV)
6. Nha Trang (CG I TFORCEV)
7. Pleiku (Sr Advisor II Corps)
8. Saigon/Tan Son Nhut (10 Local Subscribers)

(15) Air Transportable Communication Units (ATCU)

(a) These units (12) are in the Navy inventory to provide communications capability for contingency operations. The ATCUs are dispersed among various naval commanders and are usually located at a NAVCOMMSTA. These units are configured in air transportable vans and transportation of the entire unit (ATCU 100A) can be achieved in three C-124/C-133 type aircraft. When an ATCU is deployed, the supporting NAVCOMMSTA provides a nucleus crew of one officer and five enlisted. ATCUs in the past have been activated for space recovery support and contingency operations in the Mediterranean, Caribbean, and Southeast Asia.

(b) ATCU-100/100A capabilities. The ATCU 100 and 100A are identical except the 100A has two 10 KW transmitters in addition to the ATCU 100 equipment. The ATCU-100 can be transported in one C-124 type aircraft. All ATCU 100A can be deployed as ATCU-100 systems. The capabilities shown in TAB II can be provided simultaneously by an ATCU-100A.

~~SECRET~~

~~SECRET~~

(c) Currently the ATCUs are positioned as follows:

<u>Number</u>	<u>Location</u>	<u>Control</u>
1	Can Tho, SVN	CTF-166 (GAME WARDEN OPs)
2	NCS Puerto Rico	CINCLANTFLT
3	Danang	III MAF
4	NAVSTA Wash., D.C.	CNO (Op-94V)
5	NCS Norfolk	CINCLANTFLT
6	NCS Japan	COMNAVFORJAPAN
7	NCS Philippines (Currently deployed to U Taphao, Thailand)	CINCPACFLT
8	NCS Honolulu (Supporting NASA - in standby status to be deployed on carrier for recovery operations)	CINCPACFLT
9	NCS Washington (Presently being transported to NCS Philippines to replace ATCU sent to U Taphao.)	CNO
10	NCS Morocco	CINCUSNAVEUR
11	NCS Spain	CINCUSNAVEUR
12	NCS London	CINCUSNAVEUR

16) CINCPAC Narrow Band (HF) Secure Voice Requirements

(a) Analysis of HF voice communications and other intelligence has indicated unencrypted voice communications provide the enemy with a lucrative source of classified information. This problem has essentially been eliminated in the case of digital (teletype, etc.) communications through link encryption. Presently, a gap exists between short range tactical HF/VHF encrypted voice

~~SECRET~~

~~SECRET~~

(KY-8/28/38, programmed for FY 67 introduction) and the DCS point-to-point secure voice system, TALK QUICK. This gap exists in the area of medium-to-long-range (HF) tactical voice communications. US monitoring and analysis of these communications reveal that such transmissions consistently contain intelligence which the Soviet Union and other less sophisticated opponents can exploit in prewar planning and, during hostilities, in the execution of their strike plans and circumvention of our own. The types of information being revealed concern operational weaknesses, problems with weapons systems, material shortages and actual combat intelligence. Of particular concern, in relation to Southeast Asia are pre-air strike data, weapon capabilities, target coordinates, requested time of strike, target weather, time over target and type of strike. Exploitation of SAR coordination circuits may jeopardize rescue efforts.

(b) In recognizing the foregoing, CINCPAC has identified to the Joint Chiefs of Staff a total of 88 networks with 821 terminals in Southeast Asia as the minimum number of tactical voice HF networks requiring voice security protection. These requirements and the equipment proposed therefor, are being analyzed in response to a Deputy Secretary of Defense memorandum to the Service Secretaries, the Joint Chiefs of Staff, and the Directors of the DCA, DIA, and NSA. A joint task force consisting of representatives of the foregoing offices has been formed to conduct the required analysis. Joint Chiefs of Staff Action Item 316 applies and a report to the Deputy Secretary of Defense of the findings, conclusions, and recommendations is being prepared.

(c) The Initial Analysis Indicates:

1. The risk of disclosure of classified information via unencrypted voice communications in Southeast Asia is high.

~~SECRET~~

GD-23

Annex D to
Appendix G

2. Approximately 1000 terminal devices will be required to reduce the compromise of classified data on Southeast Asia HF tactical circuits.

3. While technical risk involved in early procurement of terminal equipment is low, total elimination of all service tests incurs risks that are unacceptable. Accelerated performance tests of proposed equipments therefore should be conducted.

4. It will require approximately two years from award of contract to complete delivery of equipment to users.

5. The implementation of CINCPACs minimum tactical HF secure voice requirement will require funding in the order of 50 - 100 million dollars.

1) Communications (Air Force)

a. General

(1) Communications serving 7th AF in Command, Coordination and Control of tactical air operations in Southeast Asia consist of: dedicated/common user circuits of the Integrated Wide Band Communications System (IWCS), Teletype, HF/SSB, Microwave and UHF.

(2) Long range communications of IWCS, both secure and unsecure, are used primarily by the CMDR 7th AF in the planning, coordination and execution of North Vietnam operations. Surveillance, control and assistance to tactical aircraft is exercised through the HF/SSB system. Coordination with tactical aircraft operating in the areas of North Vietnam is provided through the use of a radio relay aircraft over the Gulf of Tonkin, automatically relaying UHF conversations between the TACC(NS) and tactical aircraft. Coordination of USAF/Navy operations in North Vietnam is effected through the use of IWCS between 7th AF CP, TACC(NS) and ARAZ/CP. Additionally, a teletype (link 14)

~~SECRET~~

readout capability at TACC(NS), provides surveillance and tracking information from NTDS. A description of the communications which directly or indirectly support USAF operations in North Vietnam and coordination with Navy follows. Particular attention has been given to those systems/capabilities which support, or will support, the COMBAT LIGHTNING/SEEK DAWN PROJECT.

b. Integrated Wide Band Communications System (IWCS)

(1) The IWCS is a new, high quality, long haul communication system which is being completed in Southeast Asia. This network will upgrade and expand the present backbone communication systems. USA STRATCOM is the responsible agency for the system. Page Communications Engineers is the contractor implementing the system in South Vietnam; Philco (Communications and Electronics Division) is the contractor in Thailand. The SEEK DAWN long haul communications will be accomplished via IWCS. Due to the many demands already placed upon this communication network, it is necessary that long haul communications be held to a minimum consistent with operational requirements. The IWCS program is now in the testing stage of Phase 2. Phase 2 is an overbuild of Phase 1 which included essentially all of the communications links to which SEEK DAWN will require access. Phase 3 will not be complete until fall of 1967; however, this phase is generally to connect secondary positions into the backbone system. The IWCS network is shown in TAB C. The propagation method (tropo, microwave, cable, and the number of channels are indicated for each link. TAB C has been constructed from the latest available data from DCA, STRATCOM and contractor sources and is subject to change; however, the major elements of the system are believed to be relatively stable. The 4391 Sea Coastal Cable System is also shown.

(2) This project is scheduled to be completed in June of 1967. The interconnect to the IWCS is a responsibility of the US Army and is expected to be accomplished by August 1967. MACM and MACTHAI approvals are required to obtain channel allocations on IWCS.

~~SECRET~~

GD-25

Annex B
Appendix

c. High Frequency (HF) Radio Nets

(1) AF/USN Coordination Net. An unsecure HF voice radio net has been established between Air Force and Navy elements as shown in TAB P. This system is used by 7th AF, TACC(NS) and CTF-77 for coordination/control of operations and liaison.

(2) 7th AF HF Radio Net. This radio net has been established to insure positive and rapid unsecure voice links between CMDR 7th AF and his subordinate units to support the over-all control of AF forces in Southeast Asia. The major function of this net is providing backup communications capability to the primary system which utilizes IWCS and/or mobile tactical facilities. The system is illustrated in TAB Q.

d. 7th Air Force Operational Control Net (TAB R). The 7th AF CP has dedicated secure teletype and voice circuits to the Tactical Units as shown in TAB S. These secure teletype circuits are used to pass frag orders and other operational traffic.

e. Communication Support for COMBAT LIGHTNING/SEEK DAWN. Communications for Air Force Automated Tactical Air Control System (SEEK DAWN) will require the netting of tactical facilities at Monkey Mountain, Vietnam; Udorn, Thailand; and Tan Son Nhut, Vietnam. At Monkey Mountain and Udorn the long range radars, transmission facilities, and present tactical centers will be linked to the SEEK DAWN facilities. The two SEEK DAWN facilities, at Udorn and Monkey Mountain, will be linked together and equipped so that the facilities can function together or independently to execute total mission requirements (Tab T). In addition, communications within each SEEK DAWN facility and between various personnel and equipment will be required to insure successful coordination of tasks. Each SEEK DAWN facility will require ground-to-air transmission capability. These links will be used to communicate with tactical aircraft, airborne command posts, BIG EYE aircraft, Radio Relay Aircraft, and the Naval Tactical Data System. Tab U identifies the major ties with the TACC (NS).

~~CONFIDENTIAL~~

TAB G TO ANNEX D TO APPENDIX G

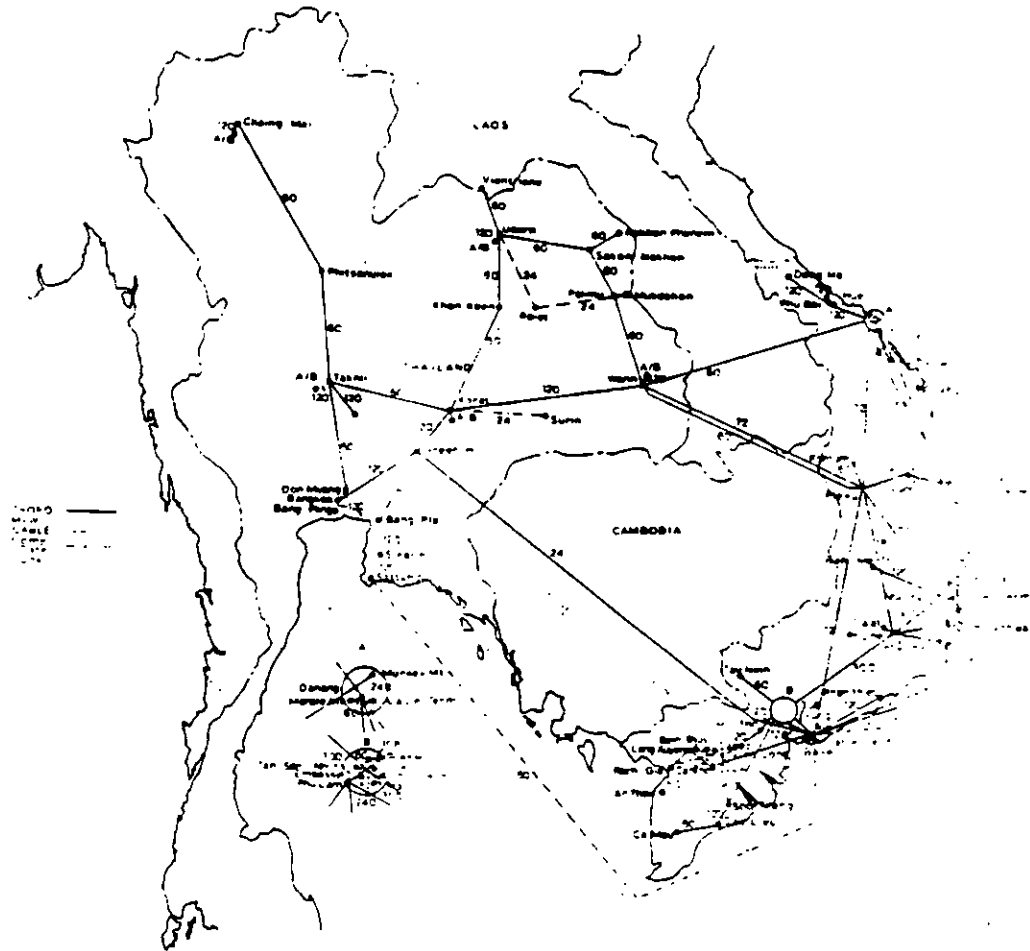

Integrated Widesand Communication System

~~CONFIDENTIAL~~

GDO-1

Tab G to
Annex D to
Appendix G

~~SECRET~~

TAB P TO ANNEX D TO APPENDIX G

AIR FORCE-NAVY HF RADIO NET

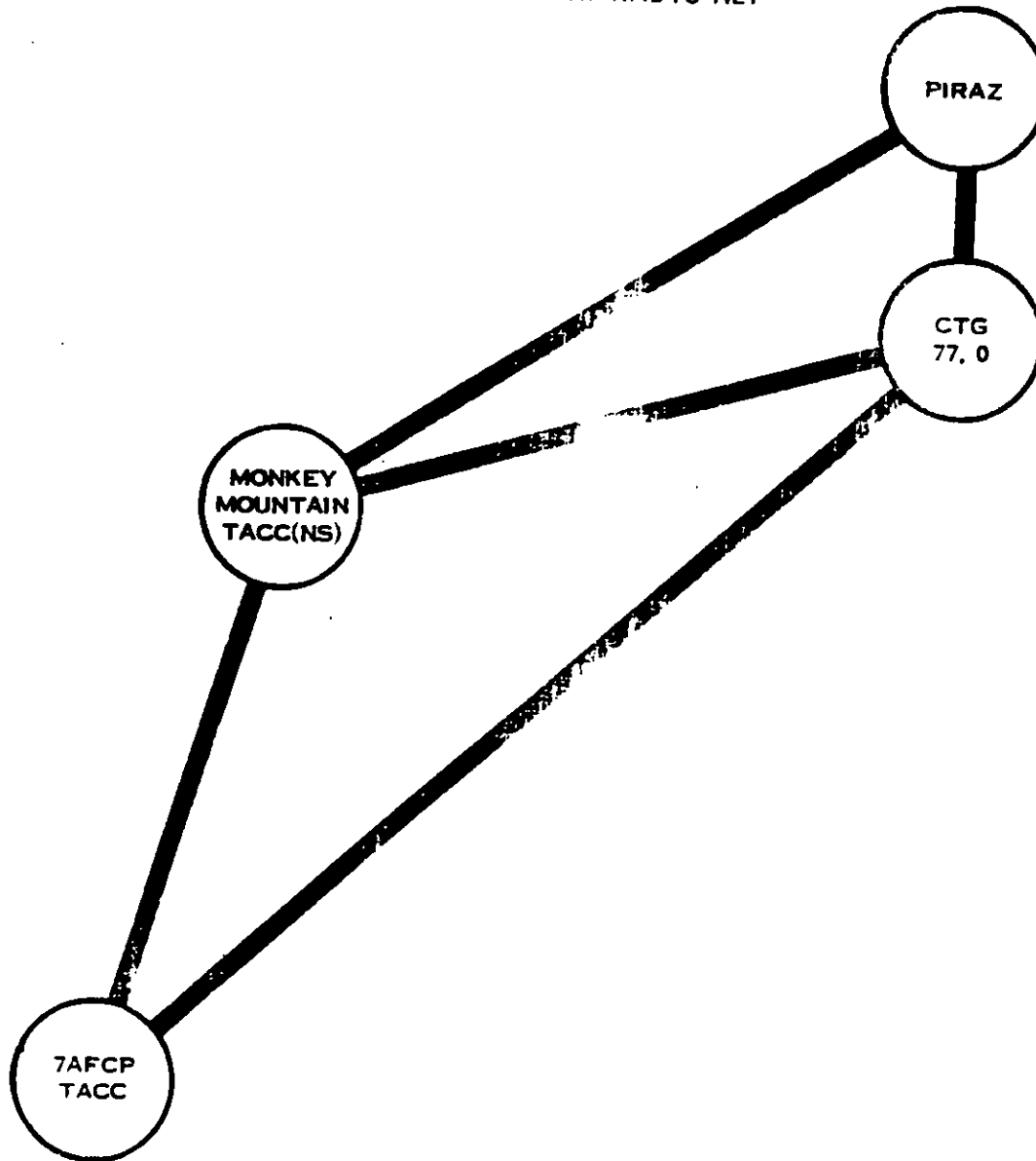

~~SECRET~~

~~SECRET~~

TAB Q TO ANNEX D TO APPENDIX G

7AF HF RADIO NETWORK

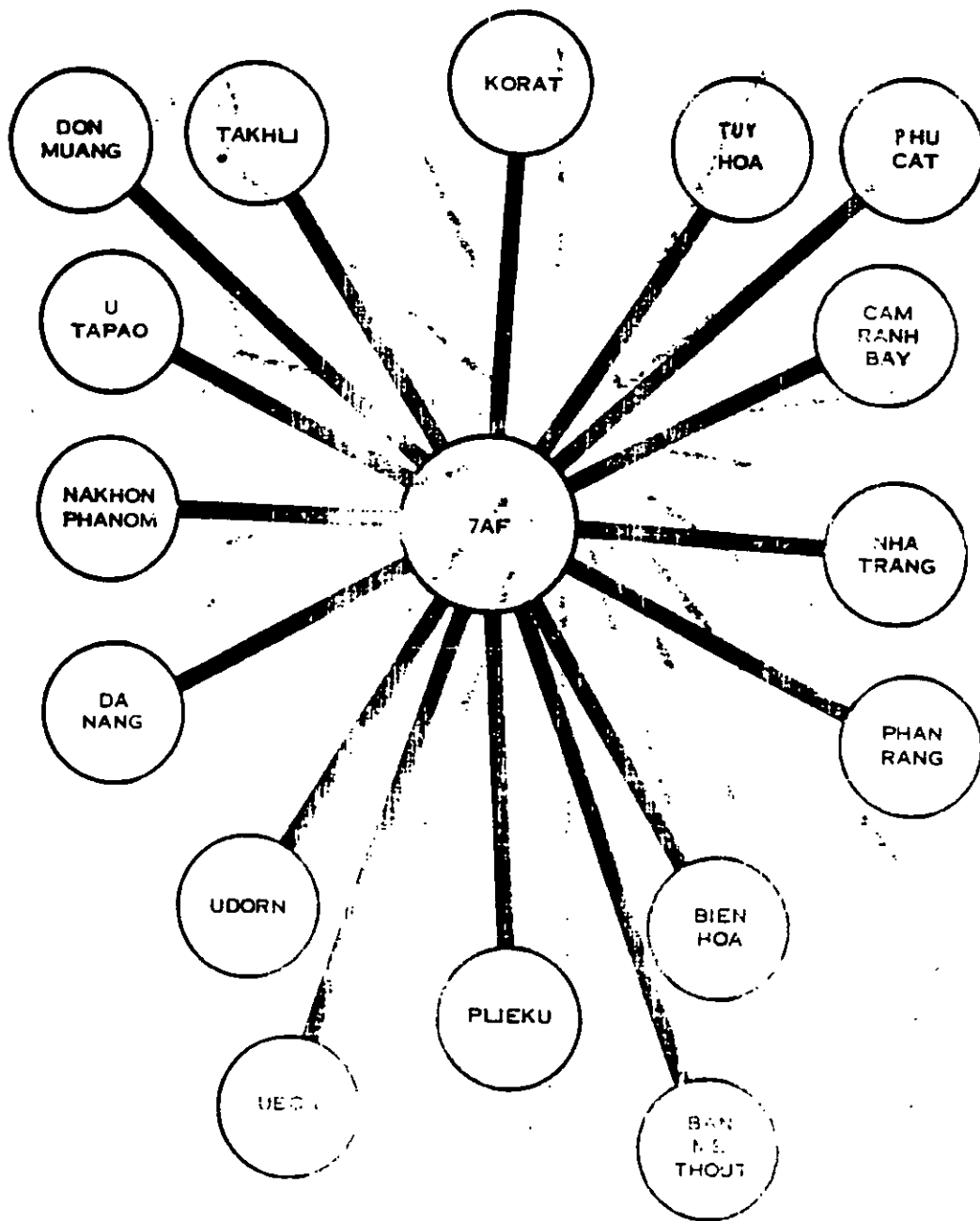

~~SECRET~~

32Q-1

Tab Q to
Annex D to
Appendix G

TAB R TO ANNEX D TO APPENDIX G

7AF OPERATIONAL CONTROL NET

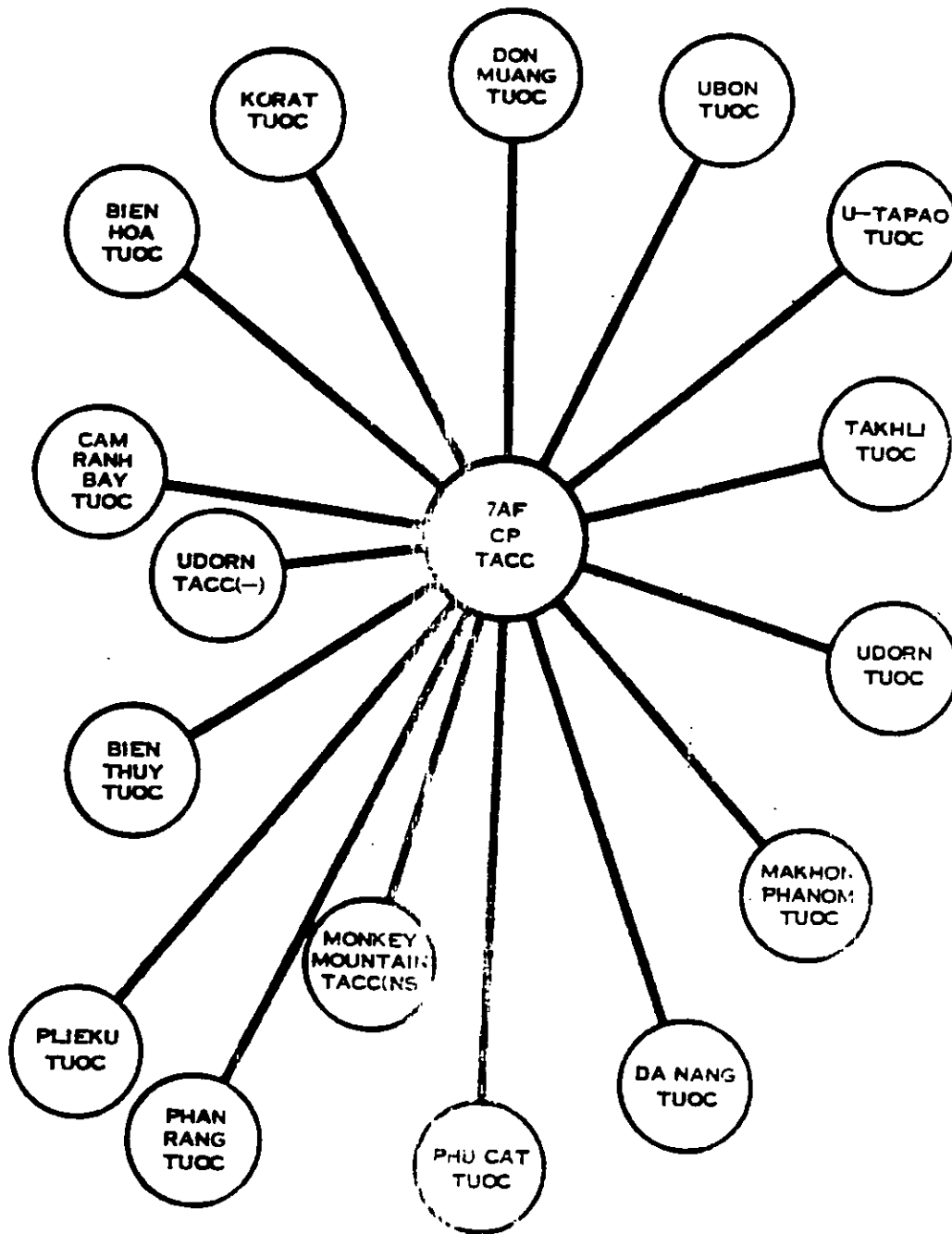

~~SECRET~~

TAB C TO ANNEX D TO APPENDIX G
7TH AIR FORCE COMMAND AND CONTROL NET

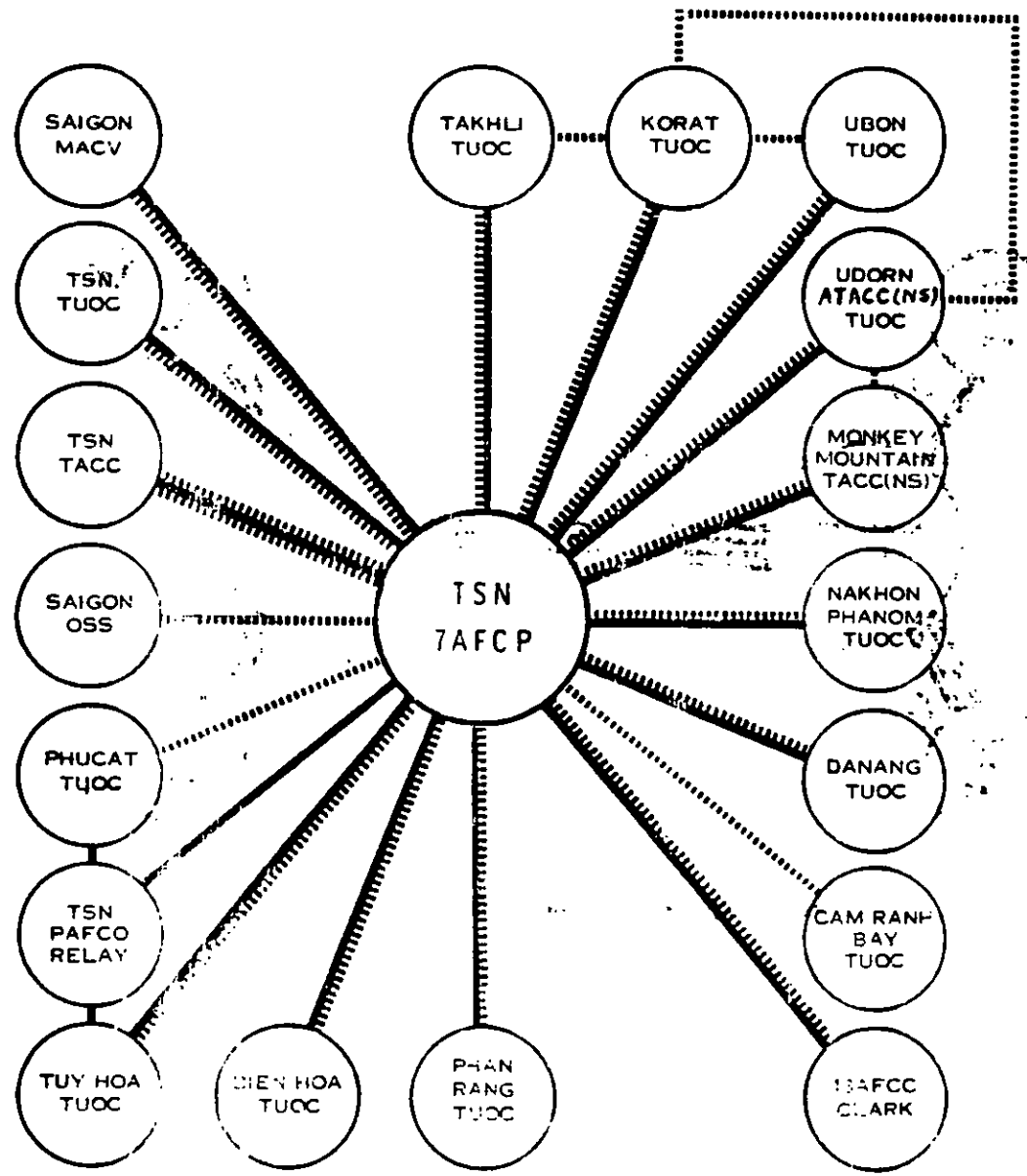

LEGEND
..... VOICE CKT
———— TELETYPE CKT

~~SECRET~~

GDS-1

Tab C to
Annex D to
Appendix G

TAB T TO ANNEX D TO APPENDIX G

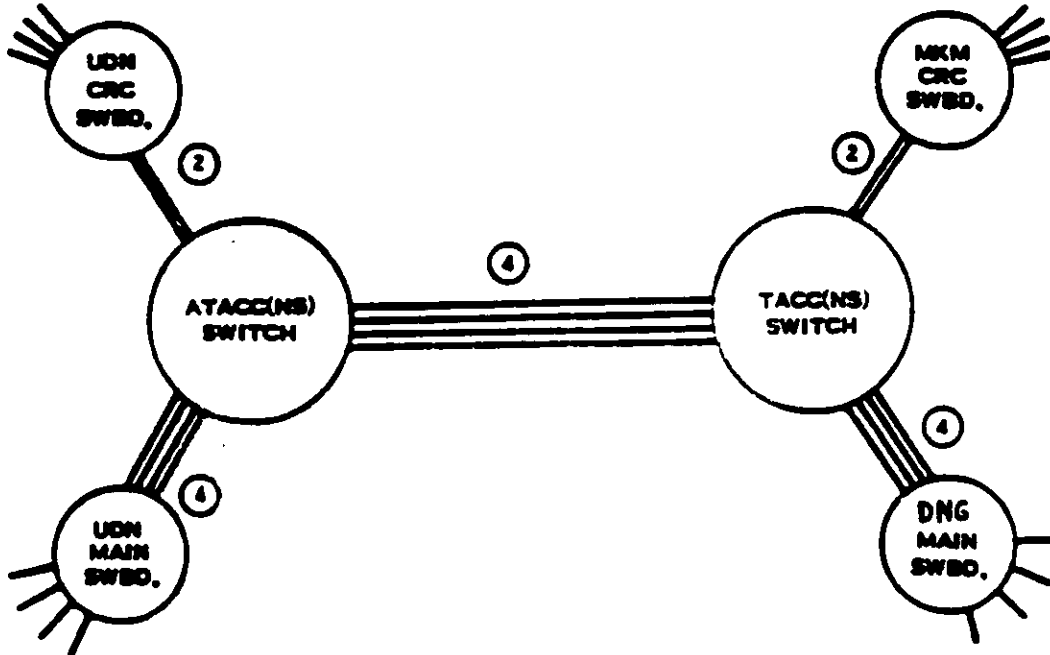

TACC(NS)/ATACC(NS) SWITCH TRUNK TIES

~~SECRET~~

TAB U TO ANNEX D TO APPENDIX G

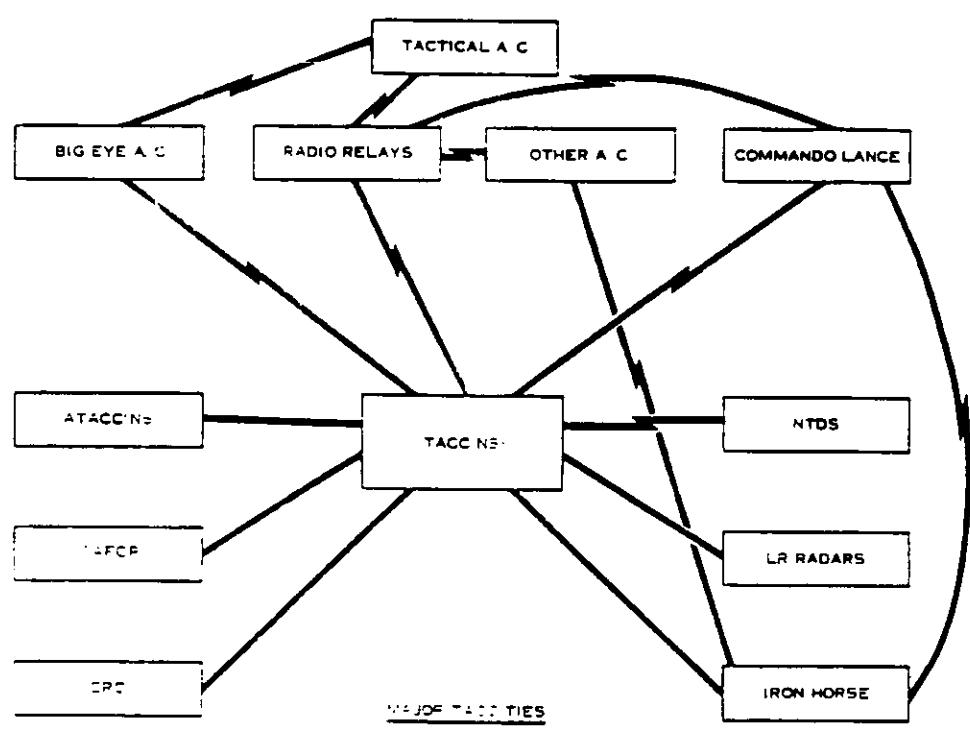

~~SECRET~~

EDU-1

Tab U to
Annex D to
Appendix G

(1) Type of Communications. The long haul and intrafacility communications will involve the transmission and utilization of data, voice, and teletype information. For each type of transmission, secure requirements exist encompassing the entire communication net. All ties with aircraft and other tactical systems will have the option to transmit secure and unsecure. The secure/unsecure option will be exercised by facility personnel on a demand basis. All transmissions of data, voice, and teletype, whether secure or unsecure, will be over voice frequency channels.

(2) Mode of Transmission. The mode of communication transmission between tactical operating units with the SEEK DAWN net will be of several methods. These include: cable, microwave, tropospheric scatter (tropo), HF radio, and UHF radio. Any one channel may involve one or several of these modes to complete the link. In general, all long haul links will involve tropo, short haul links, cable or microwave, and all aircraft and sea based systems UHF and/or HF radio. The specific type, mode, and number of channels for each tactical unit is described in TABs V and W.

(3) Constraints. There are several constraints on the communication system that have been identified thus far. These have been imposed to expedite design, economize existing communication links, and to insure established operating procedures. These requirements are as follows:

(a) All long haul communications will utilize the Integrated Wide Band Communications System (IWCS). Concerted effort must be made to minimize the SEEK DAWN dedicated channel requirements on each IWCS trunk and the system in general.

(b) Voice recording will be required on all secure and unsecure ground-to-air aircraft transmissions.

(c) Automatic dial system access is required between positions within each SEEK DAWN facility, between each facility, and to local tactical unit

TAB V TO ANNEX D TO APPENDIX G

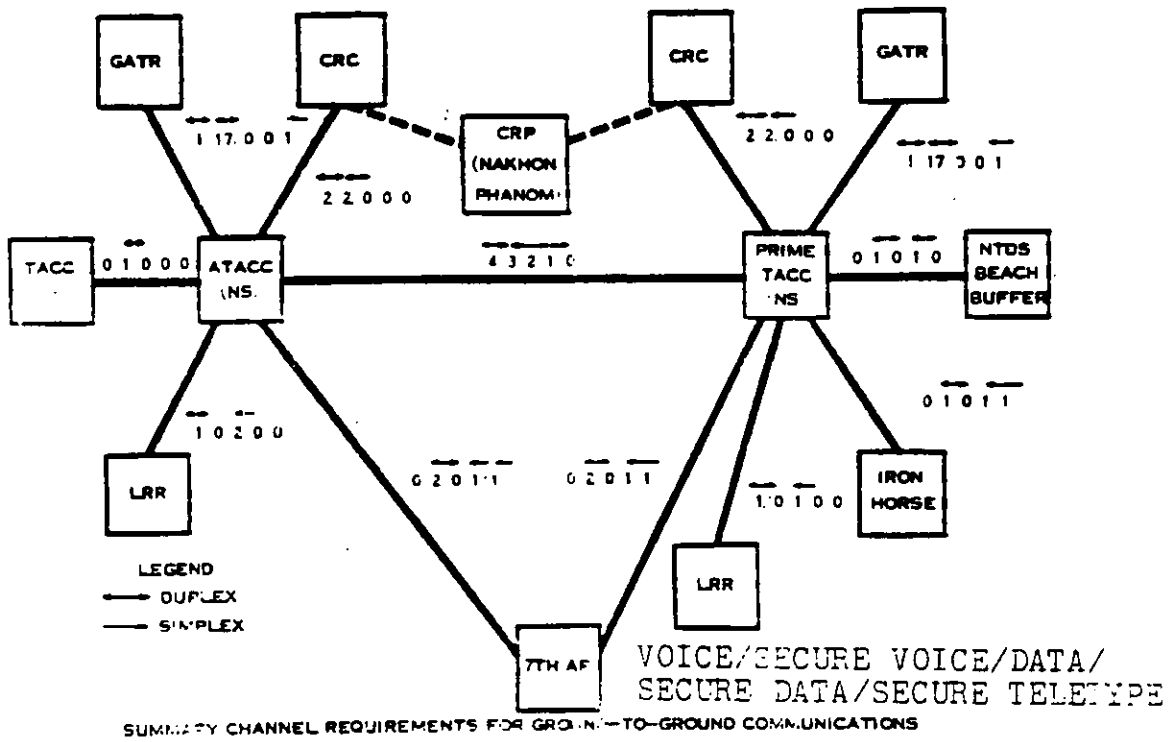

~~SECRET~~

PDV-1

Tab V to
Annex D to
Appendix G

~~SECRET~~

TAB W TO ANNEX D TO APPENDIX G

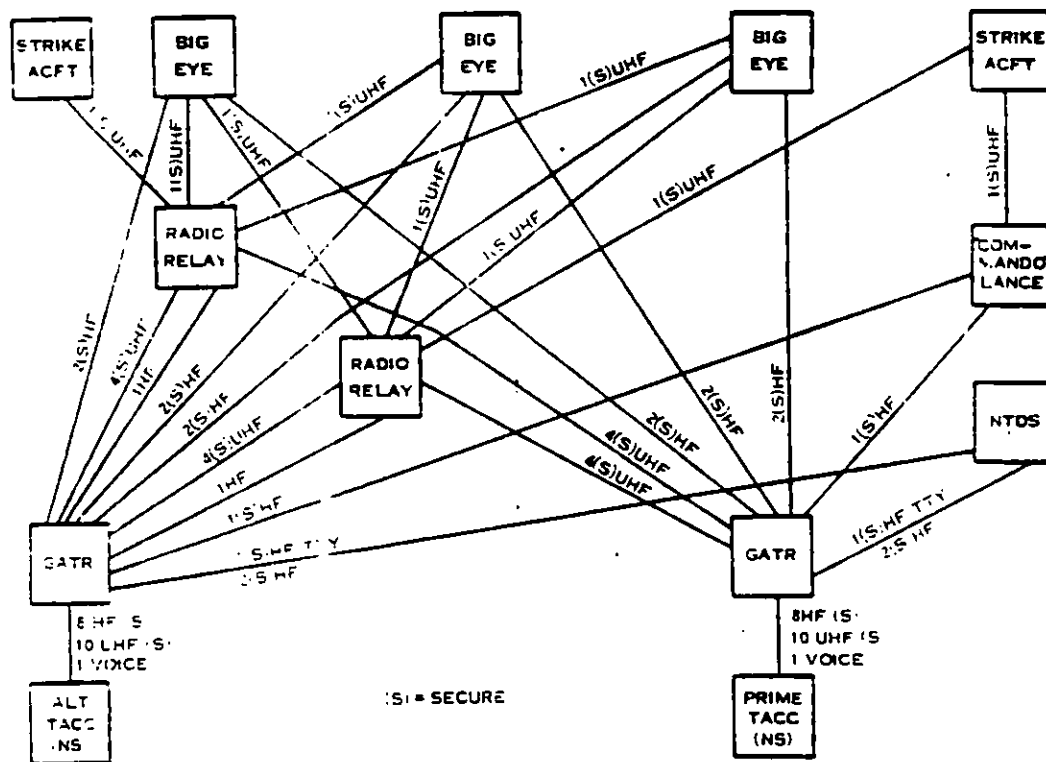

SUMMARY OF RADIO COMMUNICATION REQUIREMENTS

~~SECRET~~

switching centers. Precedence capability over daily circuits will be available to command positions at each facility.

(d) All dedicated G/G voice links will have the option for secure or unsecure transmission. Several will be hot lines, others will be multiple access.

(e) All G/A transmissions will be optionally secure or unsecure by operator switch action. Provision for simulcasting on at least two channels will be provided.

(f) All console operator's communication needs for G/A secure and unsecure and G/G unsecure will be consolidated into a console communication wing panel. Two functionally identical wing panels will be provided for each console.

(4) System Implementation. There is a time limit on the design and installation of the communication system for SEEK DAWN. The implementation of the system is being conducted over a one year period (starting in July 66). The time period has been divided into four phases. Each phase represents a level of capability with full capability at Phase III. The programmed phases for the SEEK DAWN system are as follows:

(a) Phase I - The Phase I facility which was in operation as of July 1966 consisted of an enclosed area within the operations room of the Monkey Mountain Control and Reporting Center (CRC). The operational capability was restricted because of space and communication limitations.

(b) Phase II - This phase is an interim measure consisting of a deployable Tactical Air Control Center (TACC operations shelter and equipment at Monkey Mountain). The equipment is presently in place adjacent to the Monkey Mountain CRC. It has a capability to provide, on a manual basis, the needs of display, correlation, warning, and coordination within the area of responsibility.

~~SECRET~~

(c) Phase III - In this phase data processing and display equipment will provide for data link netting of Monkey Mountain and Udorn facilities to provide an exchange of computer processed data, including returns from the respective radars, between the two facilities. Additional computer inputs will be received either manually or digitally from all data sources available during the Phase III system. Improved secure communications will also be implemented during this phase.

(d) Phase IV - This will be primarily improvement and expansion of Phase III capability, and inclusion of full point-to-point data link netting between TACC(NS) and other automatic track and display systems in Southeast Asia.

(e) The final communication net, of necessity, requires the incorporation of some communication equipment specifically designed for capacity and desired flexibility. The specifically designed equipment installed in Phase III will have the required anticipated growth capability for Phase IV.

(5) Operational Modes. Each SEEK DAWN facility, at Udorn and Monkey Mountain, must be capable of serving the same function and as a consequence, will have essentially duplicate facilities. There will be some variation between the locations for facility layout and equipment because of land availability and predetermined ties with other systems. The two facilities will be equipped to be independently capable of satisfying mission requirements. This results in levels of operation between the facilities. Three of the various levels of operation are described below. These levels of operation are not identical as operational modes as such. They are used to facilitate the solidification communication design requirements. They do not have any relationship to actual Air Force operational concepts.

(a) Mode 1 - Both TACC(NS) Monkey Mountain and TACC(NS) Udorn processors are operating.

~~SECRET~~

GD-29

Annex D to
Appendix G

TACC(NS) is acting as control with ATACC (NS) serving as backup. Data is crosstold between processors automatically by command and control communication links.

(b) Mode II - ATACC(NS) Udorn processor is operating with TACC(NS) Monkey Mountain processor down. Command and control communication links are connected to ATACC(NS). Normal TACC(NS) Monkey Mountain subordinate tactical groups are linked to ATACC(NS) via the Monkey Mountain CRC.

(c) Mode III - TACC(NS) Monkey Mountain processor is operating with ATACC(NS) Udorn processor down. Command and control communication links are connected to TACC(NS). Normal ATACC(NS) Udorn subordinate tactical groups are linked to TACC(NS) Monkey Mountain via Udorn CRC.

(d) Communications Implementation

(a) The CRCs possess an existing communication network to many facilities with which SEEK DAWN has interface requirements, either in Phase III, IV, or later. These facilities are listed below by type:

Nakhon Phanom CRP

Weather Net

Manned Interceptor bases

COMMANDO LANCE bases

BIG EYE bases

Radio relay a.c. bases

SAC bases

ABCCC bases

~~SECRET~~

(b) Only the active SEEK DAWN facility will have complete communication capability. The present concept of operation is that only one SEEK DAWN facility will be active at any time; the other facility will be in a monitor state. The normal mode of operation (Mode I) occurs when the Monkey Mountain facility may go down due either to regular maintenance schedule or equipment failure, the communications would be reconfigured through the Monkey Mountain technical control to tie Udorn to all necessary interacting facilities. In this situation, the Udorn SEEK DAWN would be active (Mode II).

(c) Phase III Requirements. The type (data, voice, teletype), amount, and direction of external communications for SEEK DAWN Phase III are shown schematically in TAB X. The circuits shown represent the minimum communication requirements for Phase III. Circuits shown with a following (s) are cryptographically secured. The simplex teletype circuit shown between IRON HORSE (Security Squadron) and the Monkey Mountain SEEK DAWN is a temporary link during the Phase III to pass track data. The two unsecure voice lines to the local CRC are PEX to PEX common user circuits. The two unsecure voice circuits between the SEEK DAWN facilities are common circuits between the internal PBXs. Two unsecure data lines between these facilities carry the cross-tell of digitized data. All secure voice circuits are of data quality. A dedicated back-up data link between SEEK DAWN facilities via IWCS and the 4391 Sea Coastal Cable is also indicated. Also shown in TAB X is a netted link-up at Monkey Mountain between SEEK DAWN, the Security Squadron at Danang (IRON HORSE), and a Security Squadron detachment located on Monkey Mountain. A netted secure voice circuit already exists between the Security Squadron, Security Squadron detachment and the temporary TACC(NS). An additional secure voice link is being provided between the automated TACC(NS) and Danang Security Squadron. (The existing circuit will be routed to the automatic TACC(NS) when it becomes operational.) Due to the type of cryptographic equipment available,

~~SECRET~~

TAB X TO ANNEX D TO APPENDIX G

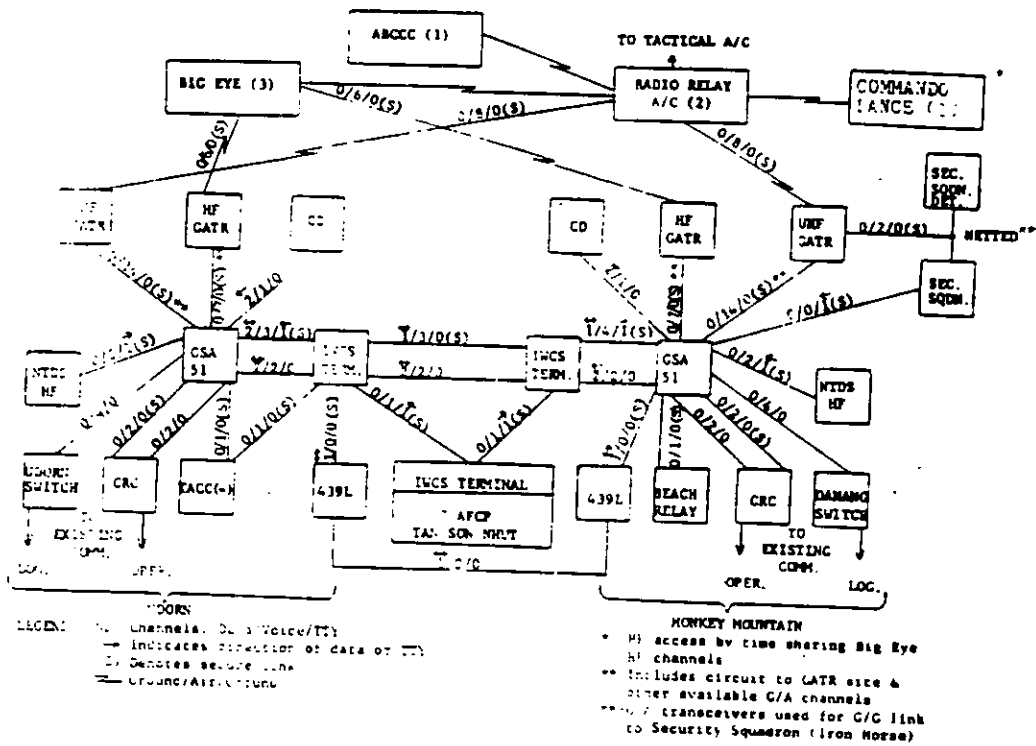

(E) TOWN COMMUNICATIONS REQUIREMENTS: PULSE III

~~CONFIDENTIAL~~

the existing circuit utilizes G/A transceivers for a G/G link.

(d) Phase IV Requirements. A similar representation for Phase IV is shown in TAB Y. Additional circuits shown in this figure are to accommodate the increased capability of SEEK DAWN in Phase IV. These additional circuits are:

- 1 simplex data - Monkey Mt. to Tan Son Nhut
- 1 simplex data - Udorn to Tan Son Nhut
- 1 duplex data (replaces simplex teletype) - Danang Security Squadron to Monkey Mt.
- 1 duplex data - Beach Relay to Monkey Mt.

(e) Communication Reconfiguration. The communication reconfiguration to enable SEEK DAWN to change from Mode I to Mode II would be accomplished by patching the available lines at the Monkey Mountain technical control. (Alternately, patching of some circuits could be accomplished at the IWCS terminals servicing these facilities; however, using the SEEK DAWN technical control facility appears to be the most flexible arrangement, particularly due to the security and data regeneration required.) The reconfiguration is shown schematically in TAB Z for Phase III and Phase IV. The common PBX lines between the SEEK DAWN sites are utilized to route communications through Monkey Mountain to Udorn.

f. Radio Relay Aircraft

(1) Two KC-135 aircraft have been modified and equipped with five high powered ARC-39 radios. These aircraft are in Southeast Asia and are employed to extend the UHF capability of the TACS. In addition, the radio relay (WAGER) provides a surveillance/control channel between BIG EYE and the TACC(NS), as well as providing this TACC with a real time monitor capability of all Border/MIG/SAM warning messages initiated by other agencies on the Guard Channel. Through this means the Battle Commander is able to accomplish his assigned responsibility of insuring that such warnings are passed.

TAB Z TO ANNEX D TO APPENDIX G

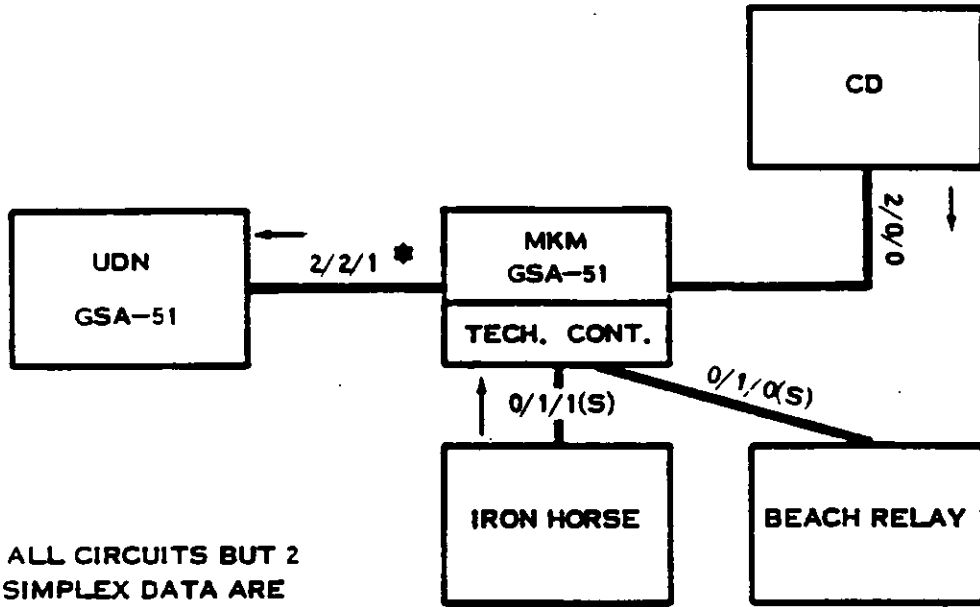

* ALL CIRCUITS BUT 2 SIMPLEX DATA ARE SECURE

SEEK DAWN PHASE III RECONFIGURATION

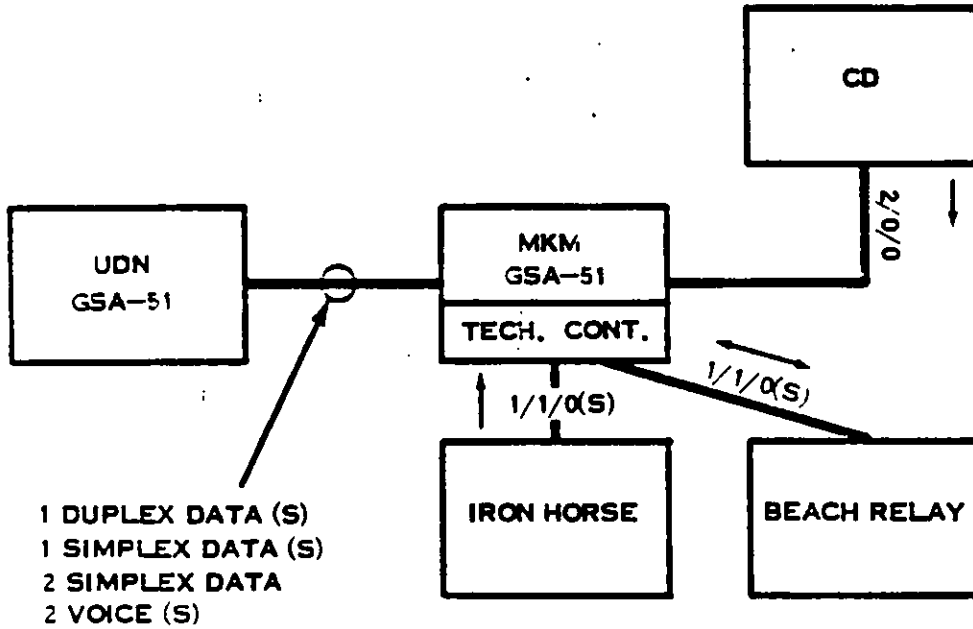

SEEK DAWN PHASE IV RECONFIGURATION

(2) The on-station time of the radio relay is presently limited to periods of scheduled air activity against North Vietnam because of a lack of aircraft. Three additional aircraft will be in the theater by end FY 67 to provide the CMDR 7th AF with a 24 hour on-station capability.

(3) The radio relay orbits over the Gulf of Tonkin at 32,000 to 35,000 feet with an orbit center at approximately 19 degrees N, 107 degrees E. From this position the Battle Commander, TACC(NS), is able to pass messages and instructions to tactical aircraft throughout the Laos/North Vietnam area. The aircraft presently provides a two channel automatic relay capability. The three follow-on aircraft will have eight improved ARC-89s (four transmitters and four receivers) for operational use, plus one spare. These aircraft will also have the capability to pass secure voice transmissions on an automatic relay basis. This improved capability will provide the needed capacity for transmission/receipt of warnings on tactical common or guard frequencies, transmission and receipt of operational intelligence, tactical control or direction of aircraft, BIG EYE crosstell and near real time transmission of mission reports.

(4) After the three follow-on aircraft arrive in Southeast Asia, the initial two will return to CONUS to be equipped and improved so that all five aircraft will have the same capability. Actions are programmed to have all five aircraft in theater and operating prior to end of FY 67.

(5) Although these aircraft act as radio relay, they still have a refueling capability and will be capable of serving as emergency tankers. Operational control for this purpose is the responsibility of the Battle Commander, TACC(NS). Additionally, the aircraft carries Radio Maintenance and Radio Operator specialists to insure operation of equipment and operational flexibility (selection of various channels, etc) to the Battle Commander, TACC(NS).

~~SECRET~~

4. (S) Communications (Marine Corps)

a. General. The equipment organic to coordination and control of Marine aircraft involved in out-country operations is described in this section. This description does not include those equipments organic to COMUSMACV, 7th AF, and TF-77, which are appropriately described in other sections of this report.

b. Organizational Equipment

(1) Marine Air Tactical Control Unit (MATCU)

(a) Radars

1. Approach Feeder/Departure Control - AN/UPC-1 (1250-1350 mc)

2. Precision Approach (GCA) AN/TPH-8, AN/FPN-36, and AN/CPN-4 (9,000 mc to 9,600 mc). These GCA radars all perform the same function but are of varying age and class. The AN/TPH-8 is the newest equipment which is provided with the AN/TSQ-18A Radar Surveillance Central.

(b) Communications

Air/Ground - UHF/AM (225 to 400 mc). AN/ARC-52 and compatible equipments in the AN/TSQ-18 and portable towers.

(c) Navigation Aids

1. TACAN, AN/TRN-14

2. UHF Radio Beacon, AN/TRN-14

3. UHF Direction Finder (DF), AN/TF-4, and AN/TRD-12, (soon to be replaced by GBD-11).

~~SECRET~~

GD-34

Ex I to
Appendix B

(2) Tactical Air Direction Center (TADC)

Communications

1. Air/Ground - same as TAOC (Tactical Air Operations Center) except that the phase-in date for the new family of UHF equipment will be after June 1967.

2. Point to Point - same as TAOC except that two additional types of multichannel radio-relay equipments are available for use as required. These are the AN/MRC-62, 63 VHF/FM(54-70) and the AN/MRC-60, AN/TRC-27 (4400 mc to 5000 mc). These sets are being replaced by the VRC-12 family VHF/FM radios with a multiplexer and the AN/TRC-97.

3. Tropospheric Scatter - same as TAOC.

(3) Tactical Air Operations Center (TAOC)

(a) Radars (Note: each site has a MK X IFF interrogator, the AN/TRX-28):

1. Primary GCI - AN/TPS-34 (1250 to 1350 mc) three dimension, long range radar.

2. Alternate GCI - Combination of AN/TPS-22 (400 to 450 mc) search and AN/TPS-37 (5250 mc to 5310 mc) height finder.

3. Gap Filler and Autonomous Sites - AN/UPS-1 (1250-1350).

(b) Communications

1. Air/Ground - VHF/AM (225 mc to 400 mc). Presently we are only using AN/GRC-49 family (includes AN/GRC-40). These will be replaced in May 1967 by the AN/GRC-134, AN/GRC-112, AN/TYA-11 family of equipment which is capable of voice or digital data link communications.

2. Point to Point

a. HF/SSB (2-30 mc). This is the AN/TRC-75/AN/TCS-15 family of equipment which provides single channel voice/TTY and multiplex TTY capability respectively. The AN/TYQ-3 beach relay equipment will be added in August 1967 which provides an MTDS/NTDS/ATDS digital tie-in using the same frequency band but a phase quadrature modulation.

b. Tropospheric Scatter (4400 mc to 5000 mc). The AN/TRC-97 multichannel radio provides center to center communications (voice, TTY, and serial digital).

3. Control Equipment: The control displays presently used are the AN/TPA-5 family of GCI scopes with an analog intercept computer built into each display. The introduction of the AN/TYQ-2 (MTDS) equipment in May 1967 will provide a high capacity, fast reaction system which utilizes a central computer.

(4) Marine Aircraft Group (MAG-Aircraft)

(a) Communications: UHF/AM (225 mc to 400 mc) of various types.

(b) Navigation: Tacan - AN/ARN-21 series or AN/ARN-52 series.

(c) IFF: MM X transponders with SIF (note: some air-to-air interrogators may be available prior to FY 68 for F-4 aircraft).

Note: All tactical UHF radios will be provided with voice security devices as they become available (KY-25).

b. Interface Requirement. All special purpose nets required for communications with organizations external to the Marine Aircraft Wing, and not within the organic equipment capabilities, are provided by wire tie lines

~~SECRET~~

through the FMAW switchboard to the main Danang switchboard. The communications equipment for further routing is furnished by COMUSMACV or 7th AF.

c. Improved Equipment. By June 1967, the TAOC portion of the Marine Tactical Data System (MTDS) and the equipment for the TDCC will be in operation on Monkey Mountain in August 1967. See TAB B to Annex C for systems description and concept of operations.

5. (S) Tactical UHF Secure Voice Program (KY-28)

a. The KY-28 program was initiated during 1965-66 as a high priority tri-service program to provide a UHF secure voice capability for Southeast Asia tactical aircraft. Concurrent production and evaluation was conducted to meet an accelerated delivery schedule and individual equipment evaluations have been performed by each service. Technical evaluation of the KY-28 by the Air Force, Navy, and Marine Corps is complete. Radio aircraft modification kits are required in the installation of the KY-28. Modification kits for the UHF radios have been contracted for and are being delivered. Aircraft installation kits for the aircraft are being engineered/manufactured by the services or by applicable aircraft manufacturers. Installation kits for aircraft are in various stages of completion. Some installations have already begun (i.e., A-4E, RB-66, UH-34D, C-47, F-100) while others including the F-105, F-4, and F-8 series are still in engineering. The Navy initial requirements were based on equipping sufficient aircraft for seven CVAs (five on the line, two in transit), one Marine Air Wing (augmented) plus spares and training requirements. The USAF requirements were based on equipping all aircraft involved in Southeast Asia operations plus spares and training requirements.

b. Distribution of equipment is listed in Table 2. Delivery of equipments from NSA will commence April 1967 with the USN/USMC scheduled to receive 855 equipments and the USAF scheduled to receive 1060 equipments by 31 September 1967.

~~SECRET~~

3D-37

Annex D to
Appendix G

~~SECRET~~

TABLE 2 TO ANNEX D TO APPENDIX G

Distribution of KY-28(Southeast Asia OPS only + training + spares):

F-4*	96	CH-46	20
F-8	72	CH-53	40
A-4*	210	UH-34	124
A-6	13	UH-1E	27
A-3	23	O-1C	TBD***
RF-8	15	OV-10	TBD***
RA-5	12	KC-130	24
E-1B	15	EA-6A	12
EA-1	15	P-3	36
EA-3	9		
EC-121M	10		
E-2	42		
EF-10B	27		
F-57	74**	F-4C	197**
F-102	43**	F-4D	133**
RF-101	52**	RF-4C	104**
F-100D	127**	B-52D	136**
R/E-65	51**	KC-135	662**
C-130	195	EC-121	43
C-147	27	CH-3C	12**
A-1E	61	A-26	30
C-123	177	T-28	13**
F-10	34**	UH-1F	6**
HH-43	16**	HH-3E	22**
F-106	128**	T-39	16**
RF-16	17	C-7	107**
KC-130	12		

* Incl USMC requirements (RA-4C, TA-4F, etc)

** USAF: (Aircraft being modified to accept KY-28/KY-8)

*** to be determined

~~SECRET~~

GD-37a

Table 2 to
Annex D to
Appendix G

6. (S) UHF Secure Voice Communications (KY-8) Program

a. Navy. A highly accelerated program was initiated in 1965 to provide an interim (Phase I) UHF secure voice capability to surface ships and selected large aircraft (EC-121, EA-3B) participating in WESTPAC operations. Currently 65 ships (DD and larger) have equipment installed. Another 40 ships have cables and foundations installed to receive KY-8s as these ships are deployed to WESTPAC. CTG 70.3, COMCRUDEPACREP - WESTPAC, is the operational administrator of this program. Two KY-8s are provided to each CV and CC and one KY-8 to other ships. Approximately 75 KY-8s are involved. During Phase I (1966-1970) most ships (DD and larger) will be equipped with at least one KY-8 secure voice terminal. The BIG LOOK and ELINT EA-3B aircraft now have KY-8s installed for Southeast Asia operations.

b. The follow-on program (Phase II) has been formulated for 1970 and beyond. The Ship Allocation Plan is now being processed. During Phase II, all naval ships will be equipped with a UHF secure voice capability (KY-8, KY-28 or equivalent). For example, a CVA will have 22 terminals, an APA will have 22 ship terminals, four in the troop spaces and 10 portable units. Smaller ships will receive fewer installations as a function of their mission.

c. USAF. The KY-8 is being installed in selected large aircraft (BIG EYE, COMMANDO LANCE, ABCCC) and ground elements of the tactical air control system in Southeast Asia. Initial Air Force procurement of the KY-8 is 100 units. Essential control aircraft and ground control center installations have been completed. Installation in additional aircraft and ground units is being effected. All EC-121 aircraft operating in Southeast Asia now have a UHF secure voice capability.

7. (S) Graphic Equipment

a. Description of US Navy graphic equipment currently being used in Southeast Asia is shown in Tables 1 through 3.

b. A description of US Air Force graphic equipment currently being used in Southeast Asia is shown in Tables 4 through 6.

~~CONFIDENTIAL~~

TABLE 3 TO ANNEX D TO APPENDIX G

Typical Terminal Systems Used in Assigning Cryptographic Equipment

<u>SYSTEM SYMBOL</u>	<u>DESCRIPTION</u>	<u>EQUIPMENT</u>
A	ON-LINE TONE MODULATED TELETYPE SYSTEM, SIMPLEX	One each KW-7, TT-299, SGC-1A
B	ON-LINE TONE MODULATED TELETYPE SYSTEM, SIMPLEX, WITH TELETYPE TAPE FACILITY	One each KW-7, UGC-6, SGC-1
C	ON-LINE TONE MODULATED TELETYPE SYSTEM, DUPLEX	2 KW-7, one each UGC-6, TT-298, SGC-1
D	ON-LINE FREQ SHIFT TELETYPE SYSTEM, SIMPLEX	One each KW-7, URA-17, TT-299, TT-253, TT-187
F	ON-LINE FREQ SHIFT TELETYPE SYSTEM, SIMPLEX	One each KW-7, UGC-6, URA-17
G	ON-LINE FREQ SHIFT TELETYPE SYSTEM, DUPLEX	Two KW-7, one ea UGC-6, URA-17, TT-298
J	ON-LINE FREQ SHIFT TELETYPE SYSTEM, DUPLEX	One each KW-26, UGC-6, TT-298, URA-17
K	ON-LINE FREQ SHIFT TELETYPE BCST-RECEIVE SINGLE CHANNEL	Two KW-37R, 2 TT-298, 1 TT-192, 1 URA-17
L	ON-LINE FREQ SHIFT TELETYPE BCST RECEIVE WITH TELETYPE TAPE (DUAL CHANNEL)	3 KW-37R, 3 TT-298, 2 TT-192, 2 URA-17
M	ON-LINE FREQ SHIFT VIF TELETYPE BCST RECEIVE (ONE CHAN)	2 KW-37R, 2 TT-298, 1 URA-17, 1 TT-192

~~CONFIDENTIAL~~

GD-38a

Table 3 to
Annex D to
Appendix G

~~SECRET NOFORN~~

JOINT CHIEFS OF STAFF
OFFICIAL FILE COPY
JCS RAIR BRANCH 28030

~~SECRET NOFORN~~

TAB D TO APPENDIX H
SCHEMATIC OF MAIN NE LAND LOC'S

3 INDICATES MINING CUT

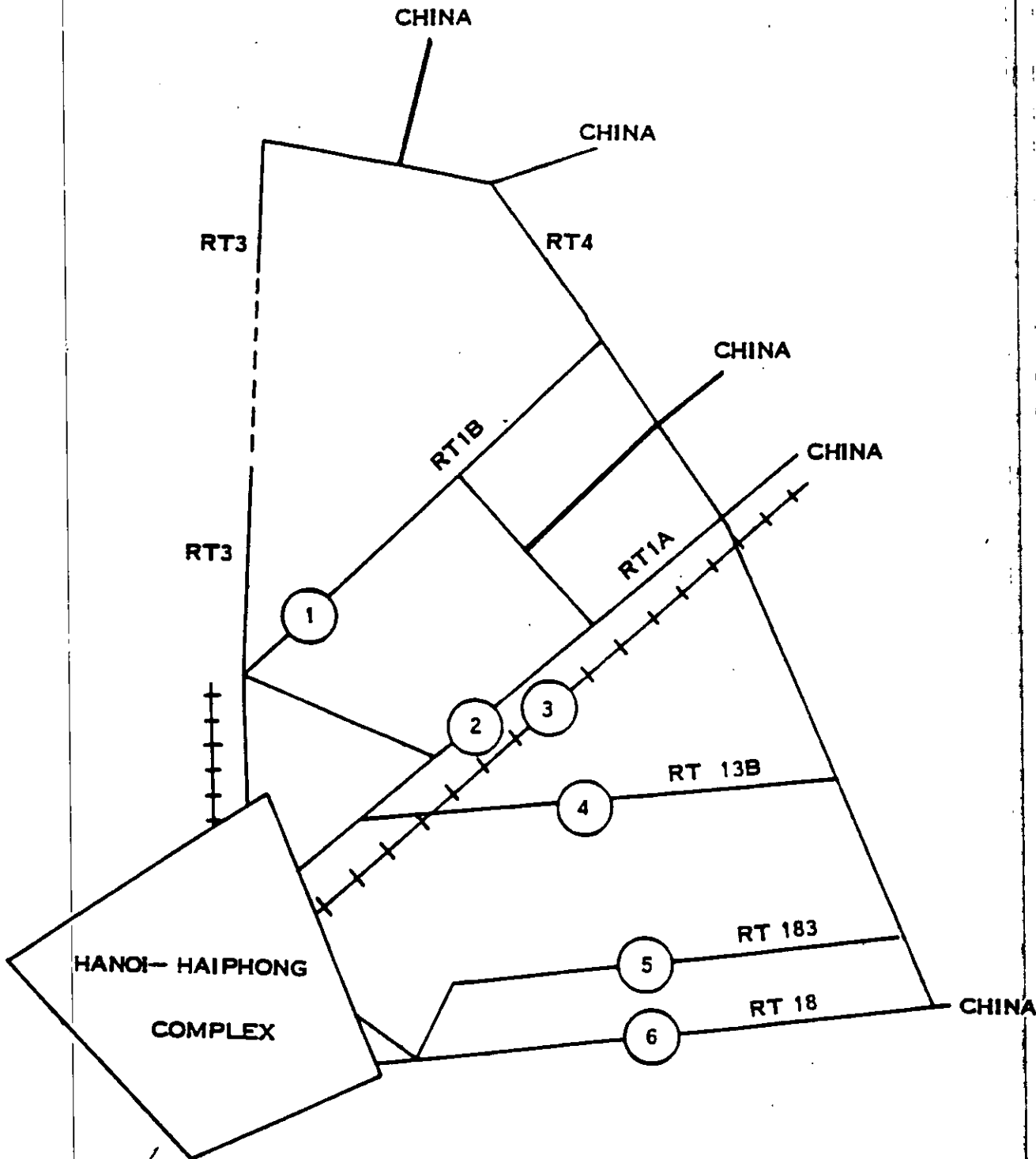

~~SECRET~~

(1) Duration and intensity of operations in the area where the defenses are to be destroyed.

(2) Sufficiency of equipment and weapons to destroy the defenses rather than to suppress or damage them.

~~SECRET~~

H-52

Appendix H

(2) Leverage Effect. For a given single event kill probability for such events, the probability of at least one kill is $p_k = 1 - (1-p)^n$. When p is very small, this can be approximated by $p_k = 1 - e^{-np}$. Thus, the rate of change of over-all kill probability due to a change in the single event kill probability is ne^{-np} . Therefore, the increase in the kill probability can be written as the product of the following factors:

$$\Delta p_k = (n, \text{ number of events}) \times (e^{-np}, \text{ probability of no kills}) \times (\Delta p, \text{ change in single event kill probability})$$

(3) The above discussion carefully avoided identifying p with a single shot kill probability, rather it was labeled as the event kill probability. Thus, the result is applicable both to a single aircraft/single/AAA encounter where n then becomes the number of shells fired, or to an encounter of a flight of aircraft with a SAM site where n then becomes the number of times that such an encounter takes place. The fact that n is a multiplicative factor in the increase in over-all kill probability indicates the leverage effect obtained when such marginal improvements are spread over many operational weapon systems.

e. Implications of Improvements in NVN Air Defense Network. As pointed out in the development of the model at the beginning of Appendix H, the mere improvement of a portion of the air defense system of North Vietnam is insufficient basis to decide to attack that portion of the air defense system. An estimate of the net saving in losses must be made taking into account both losses in attacking the defenses and the losses sustained after that portion of the air defense network is eliminated. Factors bearing on these estimates with respect to improvements in the NVN Air Defense Network are:

In these tests, the effectiveness of the decoy in capturing the seeker improved markedly as range increased beyond 10,000 feet. In contrast, the Applied Physics Laboratory estimates summarized previously showed that enabling the seeker at larger ranges increased acquisition probability in the absence of decoys. Thus, if the Soviets have selected a long acquisition range for an IR modification to the SA-2, IR flares could reduce its effectiveness substantially.

d. Marginal Improvements to Present System. The type of improvements to the NVN Air Defense Network considered here are those which probably would result in a very small increase in the single shot, or single engagement, effectiveness. The magnitude of this increase in performance is not estimated for the various types of improvements. The leverage effect of such improvements when applied to the large number of sites presently operational in North Vietnam is examined.

(1) Representative Improvements. The list of improvements suggested here is not meant to be complete. Their introduction can be gradual and applied to any desired proportion of the weapon systems in operation.

(a) VT fuzing for larger caliber AAA.

(b) Optical tracking backup for either FIRE-CAN or FIRE SONG. In its simplest form, manual optical tracking could provide a fair weather backup for these fire control radars.

(c) FIRECAN/FAN SONG Mutual Support. The FIRECAN can be used to provide range information to an angle tracking FAN SONG. Synchronized nearly coincident pulses from each radar can degrade ALQ-51 responses.

(d) Decrease in SAM launch warning time. By decreasing the warning time available, the effect of maneuvers may be partially overcome. This can be achieved by, for example, reduction in the power of the L-band guidance signal or a change in the phasing of S-band and L-band pulses.

SIDEWINDER combat data, is the similarity of external environmental factors for SIDEWINDER firings at MIGs and SA-2 (IR) firings at US aircraft, i.e., weather, combat uncertainties, pressures, and evasive actions. All combat firings for SIDEWINDER will assume target acquisition, although this is known to be incorrect for a few of the firings. The SIDEWINDER combat kill probability is 0.32, based on CINCPACFLT Staff Study 11-66. Thus, a rough figure for the IR homing GUIDELINE is $0.3 \times 0.3 = 0.09$. The combat statistics on SA-2 firings indicate a single shot kill probability approximately half of that estimated for the GUIDELINE with IR terminal homing.

(5) CHAPARRAL Type IR Homing Missile. Quantitative estimates of a CHAPARRAL type IR homing missile are not possible for this study. The following points are pertinent however:

(a) This type of weapon is ideal for a war of attrition. It has the desirable features of mobility, lightweight, simplicity in use, and relative cheapness. In such a context, it is acceptable to the enemy to have a relatively low P_k since such a weapon system could be employed in large numbers.

(b) Its introduction in combat may be very hard to detect. The weapon uses visual detection, optical tracking, and passive IR homing on a receding aircraft. If the weapon is used selectively on the last aircraft in a formation, detection of such a weapon system would be virtually impossible.

(6) Countermeasures. Further degradation can be achieved using IR decoys. Preliminary rough data from recent tests against a flare-dispersing B-52 conducted under Project F/O 198 provided the following results for SIDEWINDER:

<u>Missile</u>	<u>Number of Times Missile Continued to Track</u>	
	<u>Decoy</u>	<u>Target</u>
AIM-9D	27	5
AIM-9B	18	0

(b) The TACOS aircraft (EKA-3B) carried 700 pounds of chaff. Given fall rates for the chaff ranging from 1.5 fps to 5 fps, the sector described above can be seeded with chaff well beyond (10-15nm) the outer limits of the sector from an altitude of 30K provided the wind is at least 30nm in a direction toward the radar site.

(c) The ratio of chaff radar cross section to weight is inversely proportional to radar frequency, thus the number of pounds of chaff required for C-band is about one-half of that needed for X-band and for S-band about one-third of that for X-band.

(d) The above calculations, although approximate, indicate the feasibility of providing a dense chaff environment in a given sector of a radar site from beyond the lethal range of weapons associated with that site. This amount of chaff, given the uniform distribution assumed, should severely degrade the acquisition process and possibly the tracking process after a lock-on has occurred. The degradation will be reflected in the increased time necessary to separate legitimate targets from chaff. Although this tactic has been suggested as a counter to new systems, it is also applicable against the present SA-2 system.

(4) Countering the introduction of improved SAM systems by attacking the sites is not presently feasible using antiradiation missiles. Present inventories of SHRIKE are almost exclusively equipped for S-band. A limited number of C-band SHRIKE are available. SARM Mod 0 will be an S-band version; C-band versions are not specifically planned for as yet. An X-band seeker is in development but no production has been funded. However, the family of RHAW receivers do provide a capability against C and X-band threats. For the immediate future, these receivers will provide satisfactory warning and can be used for strike leading if necessary. The TOA and EELs homing systems will operate in these frequencies.

IR terminal homing. These missiles could be introduced without being an obvious escalation because they could be harder to identify and because they can supplement the present missiles.

(c) Marginal Improvements to the Present Systems. Included in this category are optical tracking, VT fuzing for large AAA, reduction of SAM warning time, lobe-on-receive-only mode for SAN SONG, and FAN SONG/FIRECAN mutual support. By making improvements in each of the large numbers of AAA and SA-2 systems in North Vietnam, a leverage effect is obtained. The small increase in kill probability spread over a large number of systems can increase losses to an unacceptable level. Most of the improvements discussed here are relatively simple and are fixes of present system weaknesses or counter-countermeasures against US countermeasures.

b. New Systems

(1) The SA-2 (FAN SONG E Radar/GUIDELINE III Missile) and SA-3 (LO BLOW Radar/GOA Missile) will be treated together in this discussion. The system characteristics of either system do not suggest a major improvement in capability over the present S-band SA-2 system. The operational employment of the C-band SA-2 as compared to that of the SA-3 seems to imply that the Soviets regard it more highly than the SA-3. For either system, a slight improvement in low altitude capability and a more maneuverable missile would be expected. The major advantage in employing either system in North Vietnam is the frequency diversity achieved. The SA-3 system uses 9100-9500 MHZ for tracking; the C-band FAN SONG uses 4910-5090 MHZ.

(2) Given a slow build-up of either system by North Vietnam, US electronic countermeasures can be deployed which should be effective. Both Navy and Air Force jammers (ALT-6 family, QRC-160 family and ALQ-49) are available in C and X-band, however, they are not presently available in large quantities and are unsophisticated (e.g., unmodulated noise instead of modulated noise jamming). Better

d. It should be noted that the number of sorties required for the mining campaign is:

(1) Less than or equal to the number of "break-even" sorties developed in the discussion of the MARKER SHRIKES,

(2) Presumably less than the number of sorties required to produce equivalent interdiction if mines are not used. Thus, it would appear that such a mining campaign should be further examined as a complement to a MARKER SHRIKE or SARM attack in the SA-2 defenses and that it would be preferable to a conventional attack on the northeast LOCs.

8. (S) Changes in NVN Air Defense Network

a. Introduction

(1) It is not the purpose of this section to enumerate all conceivable changes to the NVN Air Defense Network, nor to predict the likelihood that certain changes will take place. Rather, several interesting changes will be discussed, implications of these changes on US losses will be analyzed, and possible countermeasures to some of these changes will be discussed. It must be emphasized that the expected effect of applied countermeasures, electronic or other, is not to defeat a particular system, but to degrade its effectiveness.

(2) The possible NVN Air Defense Network improvements listed here are grouped into three categories:

(a) New Systems Known to be Available. Considered in this category are the SA-3 (LO BLOW/GOA) and C-band SA-2 (FAN SONG E/GUIDELINE III). The introduction of new weapon systems could be interpreted as an escalation by the Soviets.

(b) Missiles with Terminal Homing. As indicated by Appendix D, there is no evidence that the Soviets have missiles with terminal homing. Of the many possible Soviet uses of this guidance scheme, this Appendix considers the SA-2 with

by land. Although secondary roads providing alternate routes are not shown, it can be seen that the road net provides a number of opportunities for alternate routing. As indicated in TAB D, the system must be cut in at least six places for interdiction. If weather, enemy defenses and the like, prevent re-seeding the short (20-30 mile) road segments involved, the number of cuts required will increase.

b. The TAC study referenced in paragraph 6 above, estimates a requirement for six sorties (loaded with BLU-31/B, 42/B, 45/B, and 48/B) per road with a maximum blockage time of 24 hours. The total monthly sortie requirement is, therefore, $6 \cdot 6 \cdot 30 = 1080$ sorties to "interdict" the six routes (average Route Package VI attack sorties per month during 1966 were about 600). The interdiction thus accomplished is likely to be incomplete since weather will undoubtedly prevent the required daily reseeded.

c. The monthly aircraft losses, assuming that normal dive delivery is feasible for all necessary munitions, from such a campaign are estimated as follows:

	Monthly Sortie Rqmt for Mining	Losses/thous attack sorties		Expected Monthly Losses	
		Observ.	Poss.	Observ.	Poss.
Route 1A+NE RR	360	20	10	7.2	3.6
Other Routes	<u>720</u>	10	5	<u>7.2</u>	<u>3.6</u>
Total	1080			14	7

Since the interruption of communications through the northeast road net and railroad has implications for the total air campaign against North Vietnam as well as for the reduction in defense effectiveness, these losses cannot be treated entirely as a cost of countering the air defense system; accordingly, the basic model of this appendix is inapplicable.

then, assuming that the anti-disturbance features of the mines will require exploding them in place, at least a six-hour delay could be imposed by the three BLU-31/B mine blockages alone. To this would be added:

(1) Time to locate and report the cut, or the loss of one or more vehicles on encountering the cut.

(2) Time to transport a clearing and repair force to the cut, if past experience has not led to assigning such a force to the SAM battalion.

(3) Time to locate, dig down to, and explode located mines in place.

g. The TAC study surmises that the maximum blockage time is likely to be no more than 24 hours, especially after the enemy becomes proficient in countering the mines. However, a delay of six to 24 hours in moving the SAMs may be of tactical significance to reattack. The tactical significance of the site neutralization effort is less clear because of two major uncertainties. First, the amount of reconnaissance effort to locate new sites as they are prepared, and to keep track of those neutralized sites which are refurbished after the mines have detonated, might be beyond our resources. A significant number of sites which are not neutralized would negate the value of neutralization on others. Secondly, it is not clear that the enemy requires a prepared site for effective use of the SAM batteries. Although there is a need for precise positioning of launchers and control units, the principal gain of a site neutralization campaign would be to deny the enemy the protection of revetments and prepared AAA positions against air attack. Because of these uncertainties, it is by no means clear that these applications of land-mines are desirable, regardless of the level of aircraft losses involved. Rather, it appears that a more straight-forward use of the mine capability in an attack on SAM and other resupply would be more logical.

7. (S) Mining the Northeast Land LOC

a. TAB D is a schematic of the main roads and railroad connecting the Hanoi-Haiphong complex with China

~~SECRET~~

for rapid movement of the equipment in either direction from the site. Then it would require about six road blocks per battalion to interdict road movement. A Tactical Air Command (TAC) study* estimates that six sorties loaded:

- (1) Five aircraft with six BLU-31/B each,
- (2) One aircraft with one dispenser of BLU-45/B, two dispensers of BLU-42/B, three dispensers of DRAGONTOOTH (BLU-43/B),

could achieve a road blockage by mines on the road plus barrier fields extending across the road for about 600 feet on either side, with an expected number of about three BLU-31/B in place under the road. In addition, a number of BLU-45/B, BLU-42/B, and BLU-43/B would be on or under the road. Such road blocks could be emplaced around the site area to exact attrition when the battalion moves, to immobilize the battalion until an attack can be mounted, or to accompany a strike on the battalion. In this last case, at the time of the strike on the located battalion, mine road blocks could be emplaced with 36 additional sorties, to counter the customary North Vietnamese tactic of moving the SAM battalion immediately after attack. If the blocks are effective, there would be a good chance of relocating the battalion within a short distance of the site of the initial attack, perhaps even in the original site, and of inflicting further damage in a second attack.

f. The critical factor in this employment is the rate at which the mine blockage can be cleared. The TAC study estimates that about six hours would be required to restore a road with three 750 pound bomb craters in it. In the case of bombs, however, the craters could easily be bypassed in open terrain in a much shorter time. In the case of mines, such bypassing would be hampered by mines which missed the road, and by the anti-personnel mine barriers which extend to some distance on either side of the road. Presumably

* Headquarters, Tactical Air Command, Study DO-6-80278, "Tactical Employment of Aerial Delivered Land Mines (U)" SECRET, September 1966

~~SECRET~~

~~SECRET~~

(2) BLU-45/B (ATLM) is a 30-pound anti-vehicle weapon with a magnetic field sensing fuze, an anti-disturbance feature, carried in a dispenser and designed to penetrate about 30 inches below the surface. Dispensers suitable for multiple carriage, 30 mines per dispenser. Presumed loading (for analysis purposes) - six dispensers per attack aircraft - 180 mines. The system is designed for low level delivery and the feasibility of using the existing dispenser in a dive delivery has not yet been determined.

(3) BLU-42/B (WAAPM) - a 14½ oz. spherical anti-personnel grenade which rests on the surface, and deploys trip wires out to 25 feet from the grenade. Fuzed by disturbance of the trip wires. Carried in a dispenser, 540 grenades per dispenser. Presumed loading (for analysis purposes) - six dispensers per attack aircraft - 3240 grenades.

b. Consider an attack by four aircraft, two loaded with BLU-31/B, one with BLU-45/B, and one with BLU-42/B. With a dive bombing Circular Error Probable (CEP) of about 200 feet, and a SAM site diameter of 600 feet, about 80 percent (about 10) of the BLU-31/B and 145 of the BLU-45/B should fall inside the site. A vehicle such as a missile transported on a single random pass through the interior of the site with a total track length of 1000 feet, will cover about 36,000 square feet of actuation areas against the BLU-31/B (15 feet actuation radius plus six feet vehicle width) and about 6000 feet of actuation area against the BLU-45/B. Thus, there will be about a 0.13 probability of actuating any particular BLU-31/B, and about a 0.02 probability of actuating any particular BLU-45/B. Considering the numbers of mines present, then, this single pass could be expected to actuate one of the BLU-31/Bs, and two to three of the BLU-45/Bs. Additionally, there would be large numbers of BLU-42/Bs actuated by the vehicle running over tripwires, with consequent damage to motor radiators and personnel on the vehicles.

c. This level of threat against equipment which the North Vietnamese regard as highly valuable is not likely to be acceptable to them. Once the threat has become apparent to them, through a few initial encounters, or

~~SECRET~~

~~SECRET~~

(2) When the SAM activity level has been so reduced, further attempts to eliminate the remaining sites is probably not feasible.

(3) Attrition for the forces attacking the SAM sites is lower using SARM than SHRIKE with the Mk69 warhead.

(4) The reduction of the SAM activity level to sniping can result in lower attrition for sorties other than the anti-SAM attack sorties, if sniping itself is made difficult for North Vietnam. Sniping can be suppressed by avoiding the exposure of single or few aircraft groups. If a sniping policy is in effect, there is less chance that an SA-2 site will engage large aircraft flights.

6. (S) Mine Attack on SAM Sites and Routes

a. This section will attempt estimates, and indicate areas of uncertainty in analysis of the effectiveness of air-laid mines against SAM sites and movement routes. Subparagraph 5.g.(5)(b)* tabulates 152 SAM sites, 127 outside the 10-mile circle around Hanoi and Haiphong. With 25 to 30 battalions, of which at most 12 to 15 appear to be active at any particular time, there are always a large number of prepared sites which are unoccupied. There are indications that the North Vietnamese use these sites intermittently, moving from one to another to avoid a static deployment, and consequent easier location and attack by US forces. Aerial delivered mines offer a means to reduce this mobility. A variety of mines are in development or early production, which should be suitable for use. The principal ones considered here are:

(1) BLU-31/B, an 800 pound anti-vehicle weapon with a pressure sensing fuze, an anti-disturbance feature and an actuation counting device, delivered in a dive, penetrating six to twelve feet below the surface. Suitable for multiple carriage. Presumed loading (for analysis purposes) - six per attack aircraft.

*See page H-35.

~~SECRET~~

H-38

Appendix H

SECRET

~~SECRET~~

<u>Hi</u>	<u>Lo</u>	<u>Hi</u>	<u>Lo</u>
Probability of destroying a SAM-site per SARM sortie:			
.23	.002	.14	.001
Expected number of SARM sorties per SAM site destruction:			
4.3	500	7.1	1000
Total number of sorties per SAM site including four to eight conventional strike aircraft:			
17-34	2000-4000	28-56	4000-8000

(3) The same remarks apply to the utilization of these conventional strikes as discussed under SHRIKE Mk 69 warhead. However, it is expected that the attrition figures for the attacking aircraft should be less using SARM, since SARM retains a respectable kill probability while marking the point of impact.

i. Attrition predictions for an anti-SAM campaign using SARM are influenced by the:

(1) Launch envelope - launch is permissible beyond 25nm and above 25K

(2) The SARM can out-duel the SA-2 when launched between 10 and 15nm from the radar site.

(3) The 360 degrees warning capability of the APS-107A in S and L-band sets up a quick draw capability for the SARM launches. Thus, from an attrition point of view, an anti-SAM campaign with the Standard ARM appears to be more desirable than a campaign using the MARKER SHRIKE.

j. The conclusions one can draw from this discussion are:

(1) An anti-SAM campaign using SARM is feasible if the objective is to lower the SAM activity level to that of sniping.

~~SECRET~~

~~SECRET~~

Sorties Required for an Anti-SAM Campaign
Using SARM Alone

Probability of F/S acquisition per sortie:

Hi	Lo	Hi	Lo
.75	.006	.75	.006

Probability of killing a F/S:

.26	.26	.26	.26
-----	-----	-----	-----

Probability that a killed F/S is permanently damaged:

2/3	2/3	1/3	1/3
-----	-----	-----	-----

Probability of permanently killed F/S per sortie:

.13	.001	.065	.0005
-----	------	------	-------

Expected number of sorties to permanently kill one F/S:

7.7	1000	15	2000
-----	------	----	------

Number of sorties required to destroy 30 F/S in a two week period:

230	30000	450	60000
-----	-------	-----	-------

It can be seen from the above that an anti-SAM campaign using SARM alone is only feasible for high F/S activity levels. If it is desirable to reduce SAM activity to the sniping level, this can be done with the number of sorties indicated in columns (1) and (3) of the above over a two-week period depending upon the repairability of a damaged F/S. This is believed to be a reasonable expected outcome of an anti-SAM campaign since while the number of sorties is sufficient to kill all 30 sites, it is likely that F/S activity will regress to a low level before 30 sites are killed.

~~SECRET~~

~~SECRET~~

(2) Transfer of SHRIKE to a different target after launch.

(a) Since an anti-SAM campaign using SARM will face similar problems, it will be assumed that one-third of the successful firings will home on a radar other than FAN SONG. Thus, the probability of a kill against FAN SONG will be $2/3 \times .38 = .26$.

(b) Since most FAN SONG radar are collocated with several FIRECAN radars, it will be assumed that the use of the SARM marker, followed by a strike with conventional ordnance, will destroy a SA-2 site if the SARM was launched at a FAN SONG, a radar was killed on impact, and the marker is seen. The same values for the probability of visually acquiring the markers as used in the discussion involving the SHRIKE Mk 69 warhead, 0.5 and 0.8, will be used here.

f. Since the successful SARM will not destroy an SA-2 site, but will render it ineffective until the radar is replaced or repaired, a continuous campaign must be conducted against SAM sites if only the SARM is used. Two sets of numbers will be used to indicate the repairability of "killed" FAN SONGs. One set is:

(1) 1/3 of the successful kills against FAN SONG are unreparable.

(2) 2/3 of the successful kills against FAN SONG are repairable in one week.

The other set interchanges the 1/3 and the 2/3.

g. The various parameters explained above can now be combined to obtain an estimate of the number of sorties and weapons required to conduct an anti-SAM campaign using SARM alone. The probability of killing a FAN SONG per sortie is the product of the following factors:

(1) Probability of acquiring a FAN SONG per sortie, .75 and .006.

~~SECRET~~

H-33

Appendix H

(b) The number of sorties required where SARM is used initially followed immediately by a strike of four to eight aircraft carrying conventional ordnance.

d. The probability of acquiring a FAN SONG radar during a sortie depends upon the level of strike activity in the vicinity of the SAM sites, as well as the total number of operable sites in the area. Given the sensitivity of the APS-107A identification and acquisition system, it is reasonable to assume that in a dense SAM environment, with a high level of strike activity that the probability of F/S acquisition is near unity. As the anti-SAM campaign continues and if it is effective, the number of F/S radiations will decrease. Since this decrease will likely be the result of a policy change by North Vietnam rather than be related in a continuous fashion to the number of surviving SAM sites, a step change in the probability of acquisition will be assumed. This lower probability will occur after say, N sites have been destroyed. The two values chosen for the probability of acquisition per sortie, 0.75 for high level SAM activity and .006 for low level SAM activity, are the same as used for the SHRIKE Mk 69, warhead analysis. Because of the better detection and identification capabilities of the APS-107A, these are conservative estimates leading to an overestimate of the number of sorties required.

e. Although initially launched at a FAN SONG, the SARM may lose tracking of the FAN SONG and then reacquire a FIRECAN. Thus, although a radar may be killed, it may not be a FAN SONG. Using the NOTS estimated for 1966 successful SHRIKE firings, 94 targets killed were FAN SONG and 44 targets killed were FIRECAN. Although the actual intended target is unknown, the FAN SONG radar does rate as the priority target for SHRIKE missions. It will be assumed that firings at FIRECAN RADARS were:

(1) Firings in the absence of FAN SONG emissions or at the end of missions,

~~SECRET~~

that 11 grain fragments can only damage exposed radar components (wave guides, cables) and antennas. How much more effective 13 grain fragments with a higher velocity are likely to be is unknown. The number of hits on a F/S antenna or van needed to prevent its use may be quite large. The calculated single shot kill probability, Pssk, for SHRIKE in a loft delivery, taking into account only CEP and warhead lethality is .8 (Source-JMEM). The kill criterion is damage sufficient to prevent the radar functioning satisfactorily for at least four hours.

(3) The SARM warhead lethality data were computed using the radar van as the target for the blast and fragmentation, with the missile homing on the antenna mounted on top of the van. For the predicted CEP, 21 ft., the conditional kill probability is computed to be about 0.98 for expected terminal delivery parameters. For a revetted van, the single shot kill probability is estimated to be about 0.9. The probability of kill due to blast alone, Pkb, is about 0.31. This value is obtained if the warhead is activated by contact.

(4) This discussion indicates that the SARM may be considerably more effective in damaging a F/S radar and associated equipment than the SHRIKE. The radius of blast damage is increased by about 25 percent due to doubling the HE portion of the warhead. The fragmentation portion has the capability of penetrating the radar van with 130 grain fragments at an initial velocity of 6000 ft/sec. On the other hand, a single SARM is not capable of destroying peripheral equipment associated with the SA-2 system. Therefore, two cases will be examined:

(a) The number of sorties required where SARM is used alone, giving it a probability of mission success of .38 against a radar. Some of the radars killed are not FAN SONG types, and some of the killed (damaged) radars are repairable.

~~SECRET~~

(b) The marker warhead is part of the main warhead. It achieves about five minutes of visible smoke through the addition of pyrotechnics to the main warhead.

b. Using the preceding characteristics of the SARM, an estimate of the number of sorties required to conduct an anti-SAM campaign will be obtained. Because of the positive BDA, no missile firings should fall into the category UNKNOWN. Thus, using NOTS data for 1966 for SHRIKE firings, a reasonable upper limit for the missile kill probability is 0.38:

Shrike Firings 1966

<u>Probable Kill</u>	<u>Probable Miss</u>	<u>No test</u>
38%	26%	36%

Total Firings - 519

The No Test category contains firings in which the target radar was shut down before impact, as well as launches outside of the SHRIKE launch envelope. Because of the larger acceptable launch envelope for SARM, there should be fewer launches in this category. However, the probable kill category for SHRIKE is probably overstated due to the kill criterion used. Since these two factors tend to balance one another, the .38 value is considered reasonable for SARM kill probability.

c. It is necessary to discuss warhead lethality in some detail because of the uncertainty that the SHRIKE warhead is sufficient to kill rather than temporarily damage a FAN SONG.

(1) The SARM warhead, Mk 73, Mod 0 is a modified TERRIER warhead, Mk 5 Mod 7. It contains 105# HE and 112# fragmentation steel. About two-thirds of the fragments are 130 grain, the other one-third are 260 grain fragments.

(2) The SHRIKE warhead, Mk 52, weighs 145#, and contains 52# HE and 93# of 13 grain fragments. From the discussion on the CBU-24, it is obvious

U S S R U S S R U S S R U S S R U S S R U S S R U S S R U S S R U S S R U S S R

~~SECRET~~

(d) Range to target is determined by the declination angle measurement and the aircraft altitude.

(2) The SARM, by using a larger motor, has improved flight characteristics over SHRIKE.

(a) The SARM can be launched anywhere within a frontal 30 degree cone when within range of the target. The missile guides all the way to the target.

(b) The maximum range capability of the SARM is 60nm. However, at this range there is a considerably reduced probability of acquisition and target lock-on throughout the flight. More realistic launch ranges are about 30nm. with a corresponding flight time ranging from 60 seconds for a 40K launch altitude to 150 seconds for a 3K launch altitude.

(c) For launches at or above 20K, the SARM has a "quick-draw" advantage over the SA-2 for a launch range band of 10 to 15nm.

(3) The SARM has a method of providing a positive BDA. The missile sends a signal to the launching aircraft indicating whether it is homing. If it is homing, it sends the pulse train to the aircraft. The BDA equipment in the aircraft then finds a radar pulse train which correlates with that sent by the missile. If they both cease nearly simultaneously, a hit is indicated. If the missile is homing at impact, but the radar does not cease nearly simultaneously, a miss is indicated.

(4) The warhead is a blast and fragmentation type weighing 217#.

(a) Fuzing is passive, active and contact. Passive fuzing uses the radiation source signal strength as its criterion. Active fuzing (VT) is employed if the radiation source shuts off. Contact fuzing is a back-up mode to insure activation of the marker.

~~SECRET~~

severe since the bulk of the guns are in route Package VI, and attacking them initially implies exposure to heavily defended targets. At least the first few thousand sorties attacking the first few hundred guns would suffer between 10 and 20 losses per thousand sorties.

(3) An Attack on EW/GCI Sites. Although the number of these sites is only about 150-165, the data of Appendix D indicates that the position of less than 44 percent is known to within a radius of one mile. Over 50 percent have a position radius of accuracy of three to five miles, which implies hundreds of sorties will be required to locate and destroy them.

(4) Attack on Parked Aircraft. The probable losses involved in attacking all airfields containing MIGs would be on the order of the number of losses to MIGs over about half a year or more. Thus, from the point of view of reducing attrition alone, this is not a particularly interesting course of action. However, from the discussion of attacking parked aircraft and the attrition assumptions, it is obvious that the exchange rate in attacking the fighters at Phuc Yen on the ground is initially superior to that involved in air-to-air engagements. Enemy reactions such as further dispersal, the construction of covered revetments (which become targets whether or not occupied), camouflage and the like, can be expected to progressively reduce the advantage of the air-ground exchange rate over the air-to-air exchange rate and eventually make the air-to-air exchange rate superior.

(5) Other Airfield Targets. The large number of sorties required to neutralize and maintain the neutralization of an airfield by runway cratering obviously involves attrition which is significantly greater than that which would result from attacks on parked aircraft. To a lesser degree, this is also true of attacks on airfield facilities. However, the latter may become the preferred airfield targets in the event that the protection of parked aircraft is improved.

would presumably follow the pattern observed in the southern route packages; a reduction in SAM activity. While this is a desirable end in itself, the resulting impact on enroute losses from guns is unclear. The result in terms of the number of break-even sorties is linearly proportional to the reduced probability of acquiring a SAM site. A second uncertainty involves the conditions required for initially stimulating high SA-2 activity. If this can be achieved by the IRON HAND sorties alone, the estimate is adequate. If, however, heavy SAM activity requires the presence of additional strike aircraft, then the attrition estimate is incomplete.

(c) It appears from this oversimplified analysis that a systematic attempt to destroy the SA-2 system using the MARKER SHRIKE cannot be rejected out of hand. Accordingly, further analysis of the detailed tactics, equipment availability, enemy reactions, loss rates, and similar factors affecting the suitability, feasibility and acceptability of such a campaign is required. The uncertainties as to SHRIKE effectiveness, MARKER acquisition probabilities, enemy reactions, and aircraft attrition require further illumination before a systematic SHRIKE campaign can be recommended.

(2) An Anti-Gun Campaign. If all 6300 guns in North Vietnam were attacked with 10 sorties each, over 60,000 sorties or more than half of the available annual sortie effort would be required. Unless strike pilots are able to determine when a true kill is made and thereafter divert to other guns, this sortie application will kill only 63 percent of the guns. If 1966 growth rates are accurate, unimpeded resupply will add 1700 guns to the NVN inventory every six months so that 3800 guns could be available at the end of a six months campaign solely devoted to flak killing. Doubtless, gun-crew casualties would prevent all of these guns from being effectively manned; however, with the growth in the number of AAA guns, the North Vietnamese have demonstrated their ability to provide a major increase in gun crews. Losses of US aircraft would obviously be

~~SECRET~~

	<u>80% Acquire Marker</u>	<u>50% Acquire Marker</u>
Total anti-SAM Sorties RP V & VI	480-960	720-1440
SHRIKE Expenditures	120	180
Losses: Observed	4.8 - 9.6	7.2 - 14.4
Possible	2.4 - 4.8	3.6 - 7.2

The reduction in losses accruing to the anti-SAM campaign was assumed to be about 42 percent (the prior level of enroute losses) of the pre-attack attrition rate. In order for the attack on the SAM site to produce a net saving in aircraft losses, the following conditions must hold true:

1. The number of sorties in Route Package V/VI required, whether or not the SAM campaign is undertaken, must be sufficiently large that the losses which would be "saved" by the elimination of the defenses equals or exceeds the losses suffered in attacking them. This number of "break even" sorties is independent of which attrition assumption (observed or possible) is used and is as follows:

<u>Marker Acquisition Probability</u>	<u>"Break-even" follow-on sorties required</u>
80%	1200-2400
50%	1800-3600

2. Restoration of the SAM threat by repairs or resupply to a level sufficient to increase losses must require more time than that required to fly the "break even" sorties.

(b) The major uncertainty attaching to these estimates (aside from the rather large number summarized in the discussion of inputs) stems from enemy reaction to the attack. This

~~SECRET~~

The observed estimate of future attrition is based on the observed April 1966 - February 1967 rates for both Navy and Air Force (for Air Force alone in the case of RP VI heavily-defended targets) adjusted as stated in the section on attrition assumptions.

The possible estimate of future attrition is identical to that of the conservative estimate in Route Package I-IV in view of the slow and comparatively small changes in attrition rates in those areas. However, because of the recent reduction in Air Force losses in Package VI, a 50 percent decrease in attrition (except for low altitude attacks) for Packages V and VI is made to reflect the possibility that this attrition rate will continue in the future. The possible low altitude attrition estimate for these areas has been doubled to reflect the possible impact of increased gun density on the observed 1965 attrition rate.

e. Discussion

(1) An Anti-SAM Campaign Using the Marker SHRIKE

(a) The bulk of this campaign would be in Route Package V and VI. In view of the fact that many of the sorties accompanying SHRIKE pathfinders would divert to targets of opportunity or secondary targets, the average Route Package V-VI attrition rate (5-10 per thousand) may be more realistic than that estimated for heavily defended targets (10-20 per thousand). Neglecting enemy reactions and resupply, there are an average of 20 SAM units available for attack in Packages V and VI. The dimensions of a Marker SHRIKE campaign against these 20 SAM units would be roughly as follows:

~~SECRET~~

July - Sept 1966 - 693

October - Dec 1966 - 1090

January 1967 - 649

(n) The role of QRC-160 and ALQ-51 in reducing attrition is most evident in the case of losses to SAM: despite materially increased enroute exposure, as previously indicated, SA-2 effectiveness does not appear to have increased. The impact of these countermeasures on radar-controlled gunfire enroute or over target is less clear in that attrition statistics imply that radar-controlled gunfire has never been responsible for many losses. It may be that electronic countermeasures have been responsible for maintaining this situation despite the increasing fire control radar order of battle but this cannot be proved.

(5) Attrition Predictions. In view of the dynamics of attrition rates illustrated above, attrition predictions cannot be made with any degree of confidence. For the purpose of this analysis, the historical attrition rates will be used as a conservative assumption and possible excursions implied by the data will also be used. These attrition inputs are summarized below:

Losses per thousand
attack sorties

<u>Type of Operations</u>		<u>Observed</u>	<u>Possible</u>
No attacks on defenses	RP I-IV	2	2
	RP V-VI average	10	5
	RP VI heavily-defended targets	20	10
All SA-2 eliminated	RP I-IV	1.6	1.6
	RP V-VI average	6	3
	RP VI heavily-defended targets	10	6
MID threat eliminated	RP I-IV	2	2
	RP V-VI average	9	5
	RP VI heavily-defended targets	19	9
Low Altitude attacks	RP I-IV	50	50
	RP V-VI	50	100

~~SECRET~~

H-23

Appendix H

~~SECRET~~

Tab C to Appendix H

SECRET

PERCENTAGE OF USAF MISSIONS FIRED ON
ROUTE PACKAGES VI

(SOURCE: OPREP DATA
SUMMARIZED IN 7AF WAIS)

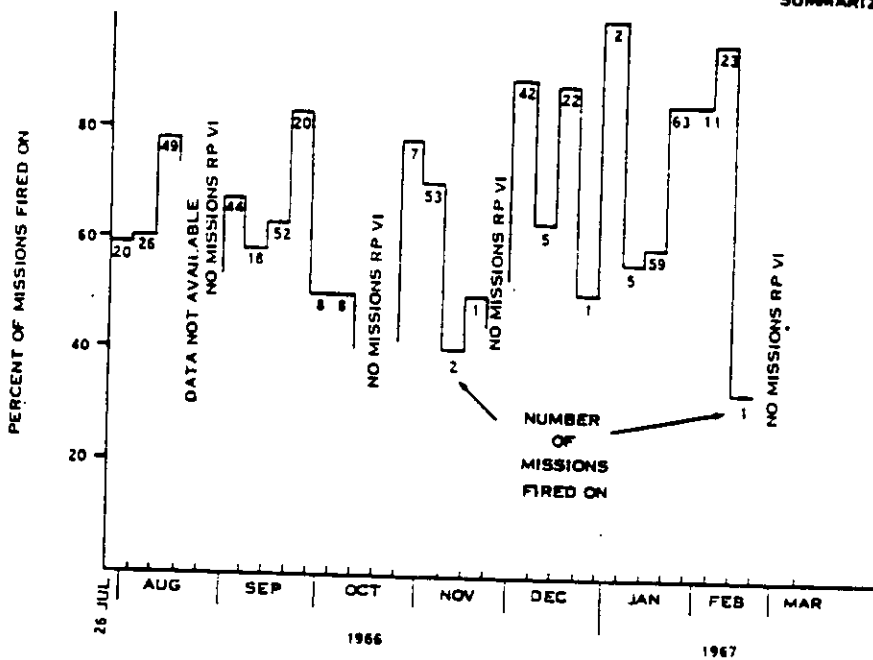

SECRET

~~SECRET~~

HC-1

Tab C to
Appendix H

~~SECRET~~

TABLE 5
SAMPLE PACKAGE VI USAF TARGETS

<u>Target</u>	<u>Dec 66</u>	<u>Jan 67</u>	<u>Feb 67</u>
Yen Vien RR Yard	66	-	-
Ha Gia POL	92	28	-
Thai Nguyen RR Yard	-	75	16
Thai Nguyen Highway Br.	-	16	-
Thai Nguyen Supply Depot	-	-	51
Bac Giang Bridge	-	15	-
Cao Nung & Vu Chua RR Yards	-	24	-
Viet Tri RR Yards	-	10	-
Lang Lau Br	-	16	-
Phu Duc RR Yds	-	16	-
Var. AA sites poss. assoc. with above	-	23	-
Vinh Yen Ammo	-	-	23
Xuan Mai Barracks	-	-	23
Sorties sampled	158	223	114
Total attack sorties	250	556	162

~~SECRET~~

H-22a

Table 5 to
Appendix H

targets were slighted during December, January, and February (data for October and November is inconclusive). A sample of OPREP 4 messages indicating continued effort against significant targets is summarized in Table 5. This sample omits WILD WEASEL operations and may omit some sorties against the enumerated targets or against others equally-significant. The percentage of USAF missions in Route Package VI which reported encountering AAA is shown in TAB C for the period July 1966 to March 1967. It can be seen that there is no noticeable down-turn in this index of exposure to the defenses. Similar targeting or exposure data for Navy operations in Route Package IV or Air Force operations in Route Package V was not derivable in the time available for this analysis.

(1) Some significant changes in tactics have occurred since October and have undoubtedly affected attrition. These include:

1 Higher enroute altitudes for both Air Force and Navy strikes relying upon QRC-160, ALQ-51, and other ECM for protection from SA-2 and radar-controlled gunfire.

2 Compression of TOTs in USAF Route Package VI strikes.

3 Slight increase in release altitude for Air Force strikes in Route Package VI.

4 Increased flak suppression with CBU-24 (primarily in Air Force strikes in Route Package VI).

(m) Since the most significant reduction in attrition occurs in connection with Air Force over-target losses in Route Package VI, it is logical to attribute this to the use of CBU-24 and to the other variations in over-target tactics. Expenditures of CBU-24, most of which were for flak suppression in Route Package VI, have been as follows:

[. . .]

~~SECRET~~

(i) No change is indicated in Navy attrition in Route Package VI. For Navy or Air Force operations other than those discussed above, sample sizes are too small to permit meaningful analysis.

(j) These recent changes in attack attrition are summarized below:

<u>Service</u>	<u>Package</u>	<u>Change</u>	<u>Factor</u>	<u>Since</u>	<u>Confidence</u>
USAF	VI	down	3.4	Sep	99.5%
USAF	I	down	4.0	Nov	97.5%
USN	II-III	down	1.5	Sep	75%
USN	IV	up	2.2	Sep	90%
USAF	V	down	3.7	Sep	95%
USN	VI	no change	--	Sep	--

These attrition changes all correlate with the prevailing poor weather of the northeast monsoon. In the case of Route Package I, the consequent major increase in high altitude MSQ-77 bombing was probably the most important reason for loss reduction. The influence of weather elsewhere is far from clear. For example, Air Force operations in Route Package VI have been flown over solid cloud cover which frequently precludes optically-controlled gunfire. This may have contributed to the past drop in losses and could result in an increase in future months. However, AA gunfire in North Vietnam has resulted in few losses above 4000-5000 feet in the past and the major change in RP VI attrition occurred in connection with over-target losses. Thus the influence of weather on reduced attrition is not obvious.

(k) Revised targeting could have been responsible for the observed attrition changes. In the case of USAF targets in Route Package VI, it does not appear that heavily-defended

~~SECRET~~

~~SECRET~~

(d) This data is insufficient for statistically-valid conclusions. In addition to indicating the possible trend in future Route Package VI attrition, it also illustrates one of the perennial problems encountered in attrition analyses. Five of the losses in March were suffered in connection with the attacks on the Thai Nguyen Steel Plant, two of them over the target. Yet, the Thai Nguyen Railroad Yard, immediately adjacent to the steel plant was repeatedly attacked in January and February with no losses.

(e) Air Force attrition in Route Package I has also shown a significant decrease subsequent to November 1966. The relevant data is summarized below:

	<u>Apr-Nov 66</u>	<u>Dec 66-Feb 67</u>
USAF RP I Attack Sorties	27,471	7,328
Losses per thousand to:		
Guns over target	1.4	0.41
Guns enroute or unknown	0.3	--
Attrition rate per thousand attack sorties	1.7	0.41

The difference in over-all attrition is significant at about the 98 percent level.

(f) Navy attrition in Route Packages II and III has been reduced somewhat since September. There is a 25 percent probability that the reduction is due to statistical fluctuations. The relevant data is summarized below:

	<u>Apr-Sep 66</u>	<u>Oct 66-Feb 67</u>
Attack Sorties	13,911	6,050
Losses per thousand	2.3	1.5

~~SECRET~~

~~SECRET~~

(b) Similarly, operations since 1965 have largely avoided very low altitude (below 500 feet) exposure in areas where defenses of any significance were expected. Based on 370 high-speed sorties below 500 feet flown during 1965, attrition was 57 aircraft per thousand exposures.* Since that time, of course, AAA density has significantly increased.

(4) Attrition Trends

(a) The major uncertainty involved in extrapolating these attrition statistics to the future is that attrition has slowly but steadily declined. This decline is undoubtedly due to a complex interaction which is only partially understood and which involves improvements in ECM equipment, improved flak suppression weapons, evolving tactics, targeting, enemy deployments, weather, and other factors. The magnitude of the reduction is illustrated below:

<u>Time Period</u>	<u>USN/USAF Attack Attrition per Thousand Sorties</u>
1965	5.1
31 Jan - 31 Mar 66	3.2
Apr - Sep 66	3.2
Oct 66 - Jan 67	2.1

TAB A is a least squares fit of attrition rate by route package for April through December 1966.

(b) A most marked reduction in attrition occurs in connection with Air Force attack sorties in Route Package VI and is summarized below:

*CINCPACFLT Analysis Staff Study 10-66.

~~SECRET~~

(d) In terms of loss cause and mission stage, Packages I through IV seem to fall into one category while Packages V and VI form another. The combined data is as follows:

	Route Packages	
	<u>I-IV</u>	<u>V-VI</u>
Losses per 1000 attack sorties cause:	1.7	8.5
Gunfire over target	73%	50%
Gunfire enroute	20%	33%
SAM	7%	12%
MIG	--	5%

(3) Other Loss Rates

(a) These loss rates are sensitive to the mix of targets attacked and tactics employed during the April 1966 through January 1967 period. For example, Navy operations in Package VI emphasize coastal armed reconnaissance and thus the Navy loss rate in Package VI reflects lower exposure to heavily defended targets. The following attrition data based on attack sorties only gives a more accurate picture of the true situation:

<u>Operations</u>	<u>Attack Sorties</u>	<u>Losses per Thousand</u>
USAF Attacks in RP VI April 1966-January 1967	2988	20.4
USN day strikes in RP VI during 1965 excluding low level deliveries	490	19.1

SECRET

~~SECRET~~

<u>Cause of Loss</u>	<u>Time Period</u>	<u>Aircraft Lost</u>	<u>At Least One Crew Member Recovered by US</u>
SA-2	24 Jul 65 - 31 Dec 66	42	14%
Other NVN Losses	1 Apr - 1 Dec 66	196	42%

This data implies that, in terms of aircrew attrition (for the duration of the war) 100 aircraft shot down by SA-2 produce the same aircrew losses as 148 losses to AAA.

(c) Losses to AA gunfire over target and enroute were as follows:

<u>Route Package</u>	<u>Mission Stage</u>	<u>Attack Losses to Gunfire</u>		
		<u>USAF</u>	<u>USN</u>	<u>Combined</u>
I	Enroute Over Target	9* 41	-- 1	9* (18%) 42
II	Enroute Over Target	-- 3	5 5	5 (38%) 8
III	Enroute Over Target	1 2	6 20	7 (24%) 22
IV	Enroute Over Target	-- --	3 18	3 (14%) 18
V	Enroute Over Target	6* 9	-- --	6* (40%) 9*
VI	Enroute Over Target	21* 27	3 9	24* (40%) 36

* Includes one loss of unknown location.

~~SECRET~~

~~SECRET~~

TABLE 4

ATTRITION OF AIR FORCE ATTACK SORTIES

		1966										1967	
		Apr	May	Jun	Jul	Aug	Sep	Oct	Nov	Dec	Jan	Feb	
RP I	Sorties	1854	1393	4070	5232	5004	3914	3645	2369	2861	2336	2131	
	Total Losses	4	4	8	10	5	6	6	4	1	1	1	
	Guns-over target	4	2	7	5	5	6	6	3	1	1	1	
	Guns enroute/unk	--	2	1	5	--	--	--	1	--	--	--	
RP II	Sorties	50	46	38	112	565	697	220	204	127	77	69	
	Total Losses	--	--	--	--	--	2	--	1	--	--	--	
RP III	Sorties	138	33	19	28	113	384	155	194	122	228	40	
	Total Losses	--	1	--	--	--	1	1	--	--	--	1	
	Guns-OT	--	1	--	--	--	--	--	--	--	--	--	
	Guns enroute/unk	--	--	--	--	--	1	1	--	--	--	--	
	SAM	--	--	--	--	--	--	--	--	--	--	1	
RP IV	Sorties	4	10	4	2	4	187	334	135	18	6	10	
	Total Losses	--	--	--	--	--	--	--	--	--	--	--	
RP V	Sorties	359	238	102	325	190	597	508	530	751	253	143	
	Total Losses	1	5	--	3	4	--	--	2	2	--	--	
	Guns-OT	1	4	--	2	1	--	--	1	--	--	--	
	Guns enroute/unk	--	1	--	1	3	--	--	1	--	--	--	
	SAM	--	--	--	--	--	--	--	1	--	--	--	
	MIG	--	--	--	--	--	--	--	--	2	--	--	
RP VI	Sorties	72	74	209	471	440	597	70	249	250	556	162	
	Total Losses	1	2	4	11	4	15	--	3	4	3	--	
	Guns-OT	1	1	4	5	8	1	--	1	1	2	--	
	Guns enroute/unk	1	1	--	--	4	2	--	1	1	1	--	
	SAM	--	--	--	--	--	--	--	1	--	--	--	
	MIG	--	--	--	1	--	2	--	1	2	1	--	

~~SECRET~~

H-13b

Table 4 to
Appendix H

TABLE 3

SECRET

ATTRITION OF NAVY ATTACK SORTIES

		1967										
		1966										
		Apr	May	Jun	Jul	Aug	Sep	Oct	Nov	Dec	Jan	Feb
RP I	Sorties	74	84	17	--	--	--	9	153	529	284	461
	Total Losses	1	--	--	--	--	--	--	--	--	--	--
	Guns-over target	1	--	--	--	--	--	--	--	--	--	--
	Guns enroute/unk	--	--	--	--	--	--	--	--	--	--	--
RP II	Sorties	1524	757	1089	1229	1055	1042	426	714	455	292	295
	Total Losses	3	2	--	2	--	2	--	1	1	--	--
	Guns-OT	1	1	--	1	--	1	--	1	--	--	--
	Guns enroute/unk	1	1	--	1	--	1	--	--	1	--	--
	SAM	1	--	--	--	--	--	--	--	--	--	--
RP III	Sorties	891	1113	1148	1207	1509	1709	1188	1083	427	715	455
	Total Losses	4	4	3	4	4	4	4	4	--	3	--
	Guns-OT	3	4	3	2	2	2	1	2	--	3	--
	Guns enroute/unk	1	--	--	1	2	1	2	--	--	--	--
	SAM	--	--	--	1	--	1	1	--	--	--	--
RP IV	Sorties	152	427	533	512	1125	1926	997	784	347	1418	599
	Total Losses	3	--	1	--	2	2	1	1	3	5	2
	Guns-OT	3	--	1	--	2	1	1	1	--	5	2
	Guns enroute/unk	--	--	--	--	--	1	--	--	3	--	--
	SAM	--	--	--	--	--	--	--	--	--	--	--
RP V	Sorties	--	1	--	--	--	47	--	7	--	--	--
RP VI	Sorties	85	119	167	400	993	318	543	205	278	129	215
	Total Losses	1	--	1	4	2	--	1	2	2	--	--
	Guns-OT	1	--	--	3	1	--	1	2	1	--	--
	Guns enroute/unk	--	--	1	1	1	--	--	--	--	--	--
	SAM	--	--	--	--	--	--	--	--	1	--	--
	MIC	--	--	--	--	--	--	--	--	--	--	--

SECRET

~~SECRET~~

c. Attrition

(1) General. Based on the OPREP data summarized in Tables 3 and 4, the attrition of attack sorties from 1 April 1966 to 28 February 1967 has been as follows:

Losses per thousand attack sorties

<u>Route Package</u>	<u>USAF</u>	<u>USN</u>	<u>COMBINED</u>
I	1.4	0.6	1.4
II	1.4	1.2	1.3
III	2.8	2.6	2.6
IV	---	2.7	2.6
V	3.4	---	3.4
VI	19.4	3.8	11.1
Overall	2.9	2.3	2.7

(2) Cause of Loss

(a) The losses involved in this attrition rate were suffered as follows:

<u>Cause of Loss</u>	<u>Route Package</u>	<u>Number of Attack Losses</u>		
		<u>USAF</u>	<u>NAVY</u>	<u>COMBINED</u>
All causes	All	135	79	214
MIG	V-VI	5	--	5
SAM confirmed & possible	II-III	1	5	6
	IV	--	3	3
	V	--	--	--
	VI	10	1	11

~~SECRET~~

~~SECRET~~

(f) The uncertainties involved in this estimate are as follows: the probability of acquiring a FAN SONG is not independent of the number of sorties attempting to acquire a FAN SONG. For example, during periods of heavy activity, there are usually no more than a dozen SAM sites active, based on all available intelligence. Significantly increasing the number of IRON HAND pathfinders searching for them will probably reduce the proportion successful in acquiring a FAN SONG. Secondly, enemy activity will probably reflect the degree of success in the attacks; as SA-2 sites are attrited, there will probably be less and less activity by the survivors. Thus the amount of effort to successfully attack a SAM site can be expected to increase towards that typical of current IRON HAND operations in Route Package J through III. Finally, the estimated SHRIKE guidance success rate, as previously noted, may be optimistic.

(5) Conventional Air Weapons versus EW Sites. The data cited in Appendix D indicates clearly that the number of sorties required to destroy an EW site is extremely high (well over 100) due to the target acquisition problem discussed previously and the ease of revetting most of the vulnerable components of the site.

(6) Airfield Neutralization

(a) Parked Aircraft. Based on PACAF estimates, 34 sorties employing CBU-24 will render approximately 47 percent of the aircraft at Phuc Yen unflyable.* Estimating the total number of sorties for eliminating all of the 40-odd fighters at this field is complicated by the possible enemy countermeasures such as further dispersal, evacuation, and the use of damaged aircraft as dummies. Neglecting these uncertainties, three or four strikes of 34 sorties each would be required to eliminate the air threat at Phuc Yen.

*SEACAAL III

~~SECRET~~

~~SECRET~~

stems from inadequate warhead lethality, the Mk 69 Marker Warhead provides a potential opportunity for increasing effectiveness by coupling a heavy conventional weapon strike with a SHRIKE delivery.

(b) The probability of achieving a successful marking of a SAM site is the product of:

1. probability of acquiring a FAN SONG
2. probability of successful SHRIKE flight to target
3. probability of visually acquiring the marker.

(c) Based on OPREP data on USAF IRON HAND operations, the probability that an IRON HAND sortie will acquire a FAN SONG and launch a SHRIKE is as follows:

<u>Conditions</u>	<u>SHRIKE Missions</u>	<u>Missions Launching at FAN SONG</u>	<u>Percent</u>
Heavy SAM & US activity (RP IV-VI July 1966)	33	25	75%
Moderate SAM; light US activity (RP IV-VI, Oct 1966)	22	5	23%
SAM sniping; heavy US activity (RP I-III, July & Oct)	173	1	0.6%

Given a SHRIKE launch, the missile appears to guide to the target 28 percent of the time. This is based primarily on those occasions when the radar ceased emitting at the estimated time of impact. A sample of 645 firing during 1966 was considered.

~~SECRET~~

bombs (750 lb) will kill a radar van, on the average. The criteria for a "kill" is damage sufficient to prevent radar operation for no less than four hours. Therefore, this predicted level of effectiveness is not realistic for more than temporary neutralization of a SAM site. The data of Appendix D, while subject to uncertainty, implies that at least four and possibly more sorties are required. Accordingly, for this analysis, it will be assumed that four to eight conventionally-loaded aircraft are required to destroy a SAM site, neglecting target acquisition problems.

(4) SHRIKE with MK 69 Marker Warhead

(a) Total FAN SONG kills by SHRIKE are assessed by NOTS China Lake at 94 during 1966.* Not only is this three or four times greater than the FAN SONG/SA-2 battalion order of battle, but high SHRIKE expenditures during certain months correlate with large numbers of SA-2 launches during the month and subsequently. Thus, while SHRIKE firings may temporarily suppress SA-2 activity, they clearly fail to achieve a discernible long term reduction in SA-2 activity. This inconsistency between estimated and observable results may be due to optimistic evaluation techniques or inadequate warhead lethality, or a combination of the two. The MK 52 SHRIKE warhead contains 93 pounds of 13-grain fragments. As indicated above, tests of the CBU-24 indicate that 11-grain fragments fail to seriously damage radars. The slightly larger and higher velocity fragments from the SHRIKE warhead undoubtedly will be more effective, but it seems likely that they will not permanently disable the FAN SONG. The positive destruction of a significant amount of the equipment in a SAM site is undoubtedly more damaging to the NVN air defense capability than the destruction of some radar components such as an antenna. The personnel, mobile equipment, and radar vans are critical items whose entire replacement is difficult. If, as seems probable, SHRIKE failure to produce a noticeable semi-permanent effect on the SA-2 defenses

*NOTS TP 4171 No. 7 "SHRIKE Firing Summary No. 7 1-31 Dec 1966."

~~SECRET~~

conducted against a simulated surface-to-air missile installation. The resulting damage, indicated below, is estimated as being minor. The six electronic equipment vans in the target array were not penetrated by the fragments. Three parabolic antennas received 18 fragment hits, but none in a location that would have damaged a vital component. One van received a direct hit by a bomblet which blew an 8 inch hole in the van side constructed of 3/16 inch mild steel; an electronic console approximately one foot below the hole suffered no apparent damage. The coaxial cable lying on the surface of the ground and linking the vans received a near miss (about 4 inches) which severed the majority of the inner cables. One simulated SAM missile was struck by three fragments from a bomb which impacted within four feet; two of the three fragments penetrated the missile.

(2) The use of the MSQ-77 for attacks on SAM sites was not analyzed due to the following uncertainties which are primarily tactical rather than analytic in nature. The CEP of 300 to 400 feet demonstrated in South Vietnam for ranges up to 50-60 nm (USAF Tactical Fighter Weapons Center Bulletin No. 8, 28 October 66) and the inherent accuracy of 1 mil in azimuth apply to single aircraft, or aircraft in tight formation, making a relatively long, straight and level run in on the target above the line of sight. This degree of accuracy implies large force levels for attacks on most SAM sites. In order to apply this tactic to SAM sites, at least some of which are presumably occupied, it is necessary to assume ECM neutralization of the SAM site. However, the QRC-160 is effective primarily for formations of aircraft with rather loose spacing in terms of MSQ-77 tactics and all jamming is subject to "burn-through" as range to the victim radar approaches zero.

(3) Visual Attack on an SA-2 Site. The Joint Munitions Effectiveness Manual estimates that two F-105 sorties, each loaded with six M-117

~~SECRET~~

~~SECRET~~

(3) AAA

- (a) Increase in CEP.
- (b) Inhibit location of hard-to-find targets.
- (c) Prevent very low altitude attacks.

Because of these limitations, this analysis should be interpreted primarily as an indicator of the types of destruction campaigns which are undesirable and identify courses of action which possess sufficient promise to warrant, not execution, but rather further detailed tactical and technical examination.

4. (S) Parameters of the Base Case

a. Number of Targets

(1) Total Order of Battle and Growth. Table 1 summarizes the number of defense targets available in North Vietnam as of early February 1967 and the growth in this target array during 1966. This growth is a net increase and reflects an unknown amount of target destruction, particularly in SAM firing units. The SAM firing battalions are not necessarily all located in known SAM sites; during any given day no more than half of the firing units appear to be active (and thus presumably at some located or unlocated site) and there is usually a substantial degree of uncertainty attached to the location of any active unit. Fighter aircraft targets and airfields are summarized in Appendix D and Table 2; growth rate during 1966 is unclear due to rotation between airfields and uncertain logistics.

(2) Targets Inside Sanctuaries. Table 1 indicates that the majority of the defenses are in Route Package VI, which contains two major sanctuaries and a buffer zone beside the Chinese border. As indicated in Appendix D, the buffer zone order of battle is subject to substantial uncertainty and will not be addressed here. The approximate percentages of the order of battle inside the Hanoi-Haiphong 10-mile sanctuaries are indicated in Table 1.

~~SECRET~~

~~SECRET~~

TABLE 2

Fighter and Airfield Targets

<u>Airfield</u>	<u>Fighter OB as of 9 Feb 1967</u>	<u>Runway Dimensions</u>	<u>Status</u>
Yunnani	32	immaterial	CHICOM sanctuary
Phuc Yen	44	9170 x 250	sanctuary
Kep	15	5975 x 155	sanctuary
Gia Lam	15	6900 x 90	sanctuary
Cat Bi	2	7900 x 170	sanctuary
Kien An	-	5900 x 140	sanctuary
Hoa Lac	-	7800 x ?	sanctuary

~~SECRET~~

H-5c

Table 2 to
Appendix H

~~SECRET~~

TABLE 1
Order of Battle Summary

<u>Defense</u>		<u>Feb 1967</u> <u>OB</u>	<u>Within 10nm</u> <u>Haiphong/Hanoi</u>	<u>Growth</u> <u>During 1966</u>
LAA/MAA	RP I-IV	2010		980
Guns	RP V	577		195
	RP VI	<u>3761</u>	<u>1282</u> (34%)	<u>2289</u>
	All NVN	6348	1282 (20%)	3464
SA-2 Sites	RP I-IV	44		35
	RP V	7		6
	RP VI	<u>101</u>	<u>25</u> (25%)	<u>48</u>
	All NVN	152	25 (16%)	89
SA-2 Bn	RP I-IV	6		3
	RP V	3		0
	RP VI	<u>16-21</u>	<u>5</u> (approx)	<u>5-9</u>
	All NVN	25-30	5 (approx)	8-12
EW/GCI	RP I-IV	64		
	RP V	14		
	RP VI	<u>68</u>	<u>27</u> (40%)	
	All NVN	146	27 (19%)	71
FC Radars	RP I-IV	69		49
	RP V	26		23
	RP VI	<u>112</u>	<u>73</u> (55%)	<u>120</u>
	All NVN	227	73 (32%)	192

~~SECRET~~

H-5a

Table 1 to
Appendix H

~~SECRET~~

3. (C) Limitations. In addition to the obvious uncertainties imposed by the enemy or inherent in the nature of existing combat statistics, the model and the basic assumptions have at least the following weaknesses:

- a. The acceptability of losses varies from that implicit in the model when very small or very large losses are involved.
- b. The model is static; the real world is dynamic.
- c. Indirect effects are not reflected.

Of these limitations, the last is the most severe, because indirect effects which are not precisely quantifiable may outweigh the direct effects of attrition. The potential indirect effects by type of defense are as follows:

(1) MIGs

- (a) Jettisoning of bombs.
- (b) Requirement for MIGCAP.

(2) SAMs

- (a) Driving pilots down into AAA envelope in the absence of effective ECM equipment.
- (b) Requirement for higher weather minimums in the absence of effective ECM equipment.
- (c) Requirement for IRON HAND missions.
- (d) Diversionary effect on pilots.
Increase in CEP and gross errors.
- (e) Requirement for ECM missions.
- (f) Reduced use of B-52s, etc.
- (g) Reduced true armed reconnaissance missions.
- (u) Eliminated U-2 missions and significantly attrited high altitude drone missions.

~~SECRET~~

~~SECRET~~

extreme, if a war is assumed to be infinite in length, and any reduction in attrition can be achieved by attacks on defenses, there will eventually come a time when the total attrition is reduced and it is therefore always desirable to attack defenses.

b. Attrition Assumptions

(1) Attrition in attacking a defense unit will be equal to, or greater than, that normally experienced in the route package where the defense unit is located, unless significantly different tactics are used.

(2) Attrition after all defenses of a given type are destroyed will be as follows:

<u>Defenses Eliminated</u>	<u>Estimated Attrition Rate</u>
SAM	Existing attrition to guns over target plus enroute losses to MIGs
Guns	South Vietnam attrition rates plus enroute losses to MIGs
MIG	Existing attrition to other defenses minus MIG losses

c. Sortie Assumptions

(1) Total attack sorties available are between 6,000 and 14,000 per month depending upon weather. (Sorties required to attack a defense unit are analyzed in subsequent sections.)

d. Number of Defense Units

(1) The initial number of defense units is given by the current order of battle.

(2) The rate of replacement of defense units will be that implied by the growth of the NVN order of battle to date, unless a sustained interdiction campaign is undertaken in the northeast.

~~SECRET~~

~~SECRET~~

thereafter are less than those which would be suffered in the absence of the attack. An oversimplified way of expressing this is that the defenses should be systematically destroyed whenever:

$$AS \geq as(n+n') + AS'$$

where A = attrition rate in the absence of a defense destruction campaign

S = total sorties

a = attrition rate in attacking defenses

s = sorties to destroy (rather than neutralize) one defense unit

n = initial number of defense units

n' = defense units introduced

A' = attrition rate after all defenses of a given type have been destroyed

S' = sorties attacking other than defense targets

All terms in the inequality are, of course, taken over the same time base; this time base must be chosen in the light of the implication of the values of the various terms.

If the entire air campaign is considered, then the sorties attacking the defenses ($sn + sn'$) plus sorties attacking other targets (S') must be equal to total sorties (S). If, however, only a portion of the air campaign (perhaps operations in Route Package VI) is examined, then the model is meaningful primarily if it is assumed that a given number of sorties will be flown whether they attack the defenses or attack other targets. If this frame of reference is used, then the equation gives the number of sorties which must be flown in the restricted portion of the campaign after the defense campaign in order to provide a net decrease in total losses. In the

~~SECRET~~

L E T T E R S E P A R A T E D

~~SECRET~~

APPENDIX E

ANALYSIS OF AN ANTI-AIR CAMPAIGN
AGAINST NORTH VIETNAM

1. (S) Introduction

a. This appendix postulates an oversimplified model for determining those cases when it is undesirable to undertake a defense destruction campaign. This model necessarily ignores indirect effects of the defenses, and there can be cases where these are more important than the direct effects. A base case representing capabilities in the near future is examined and the effects of the following potential excursions from the base case are analyzed:

- (1) Standard ARM Mod O.
- (2) Use of land mines against SA-2 sites.
- (3) Use of land mines to interdict resupply routes.
- (4) Improved enemy surface to air missiles.

b. In order to carry out these analyses, it was necessary, among other things, to predict attrition. In the course of the analysis leading up to the attrition predictions, it was determined that statistically-significant variations in attrition (largely downward) had taken place since September 1966. These downward variations existed even when high threat areas (such as Route Package VI) were examined. They do not appear to have stemmed from the avoidance of heavy defenses. As a result, a prediction of attrition in the face of increasing enemy defense strength was impossible and the credibility of the results of an already-over-simplified model was strained even further.

2. (C) The Model and Basic Assumptions

a. The Model. Neglecting indirect effects, it becomes desirable to attempt to destroy the enemy air defense system, or a part of it, if the losses suffered during the attack on the defenses and

~~SECRET~~

~~SECRET~~

APPENDIX H

ANALYSIS OF AN ANTI-ANTI-AIR CAMPAIGN
AGAINST NORTH VIETNAM

ABSTRACT

This Appendix analyzes present and predicted attrition and offensive effectiveness. It is shown that a significant and major reduction in Air Force attrition in Route Package VI has occurred since October 1966. Attacks on the SA-2 system, the EW/GCI network, and the MIG threat are examined in terms of force requirements and expected attrition. The results of this examination are somewhat inconclusive but suggest that a systematic attack on the air defense system is not warranted at this time. However, the possibility of attacking the SA-2 system using either SHRIKE with a Marker Warhead or Standard ARM, both followed up by a conventional attack, may deserve detailed operational study. Attack with air delivered land mines on SA-2 sites does not have an obvious payoff but an attempt to interfere with air defense (and other) resupply by mining in the northeast lines of communications is not without merit.

~~SECRET~~

H-0

Appendix H

~~SECRET~~

TAB B TO APPENDIX H

SECRET

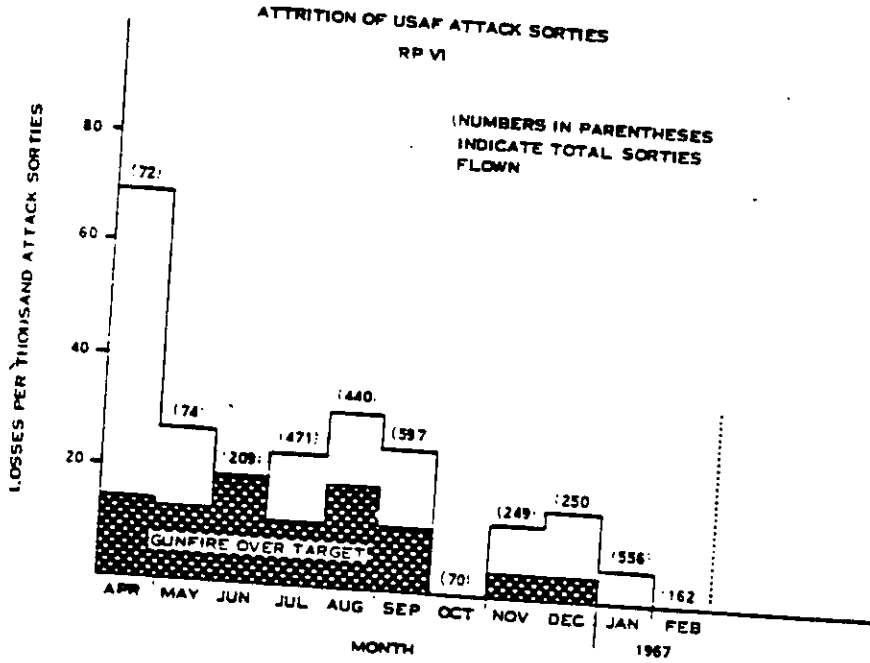

SECRET

~~SECRET~~

HB-1

Tab B to
Appendix H

~~SECRET~~

TAB A TO APPENDIX H

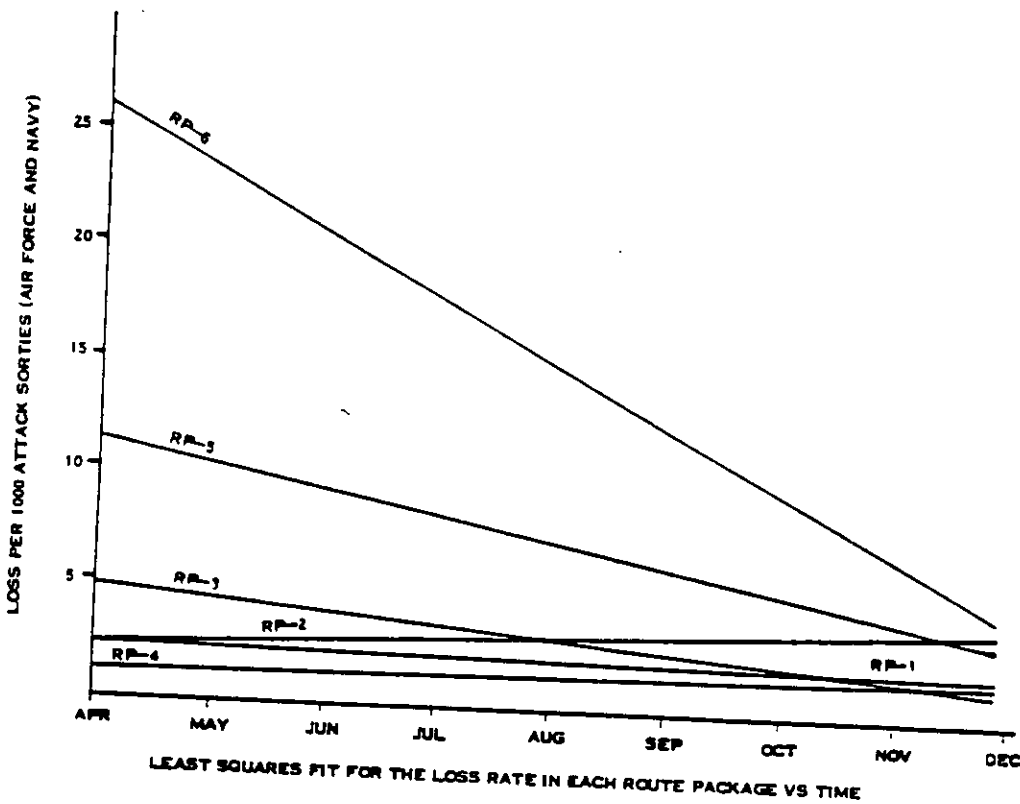

~~SECRET~~

HA-1

Tab A to
Appendix H

EXHIBIT B TO TAB D TO ANNEX F TO APPENDIX G

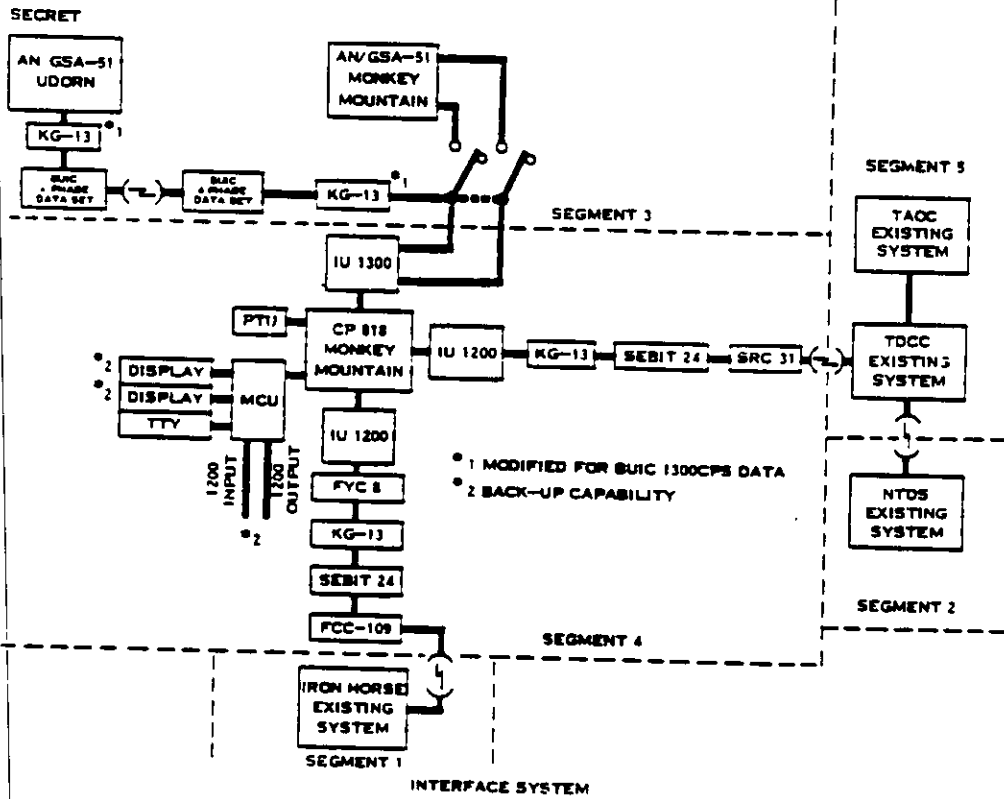

~~SECRET~~

GFDB-1

Exhibit B to
 Tab D to
 Annex F to
 Appendix G

~~SECRET~~

interchanged with fused NTDS/NTDS data via the Monkey Mountain/Hill 6-7 data link. Only unique data will be selected for transmission by both BUIC II and the TDCC. Details will be resolved by both services.

(c) Fusion at the TDCC and data interchange between the TDCC and NTDS and the TAOC take place as in the manual input phase (paragraph (1) above). The CP-818 computer at TACC(NS) will perform the TADIL B (JCS Pub 10) to BUIC II format translation for data from IRON HORSE and the TDCC and the inverse translation for data from BUIC II to the TDCC. (See Exhibit B).

3. (U) The plans/specifications submitted by Navy/Air Force/NSA are presently being evaluated for concurrence or comment by the services/agencies concerned. Although no major unresolved hardware problems exist, there are problems in developing compatible computer programs. Priority action (both industrial and service/agency) will be required in order to install and activate these systems in a timely and effective manner. Additionally, an executive agent is required to resolve differences and insure that all portions of these systems are being properly expedited by the responsible service/agency.

~~SECRET~~

GFD-3

Tab D to
Annex F to
Appendix C

~~SECRET~~

EXHIBIT A TO TAB D TO ANNEX F TO APPENDIX G

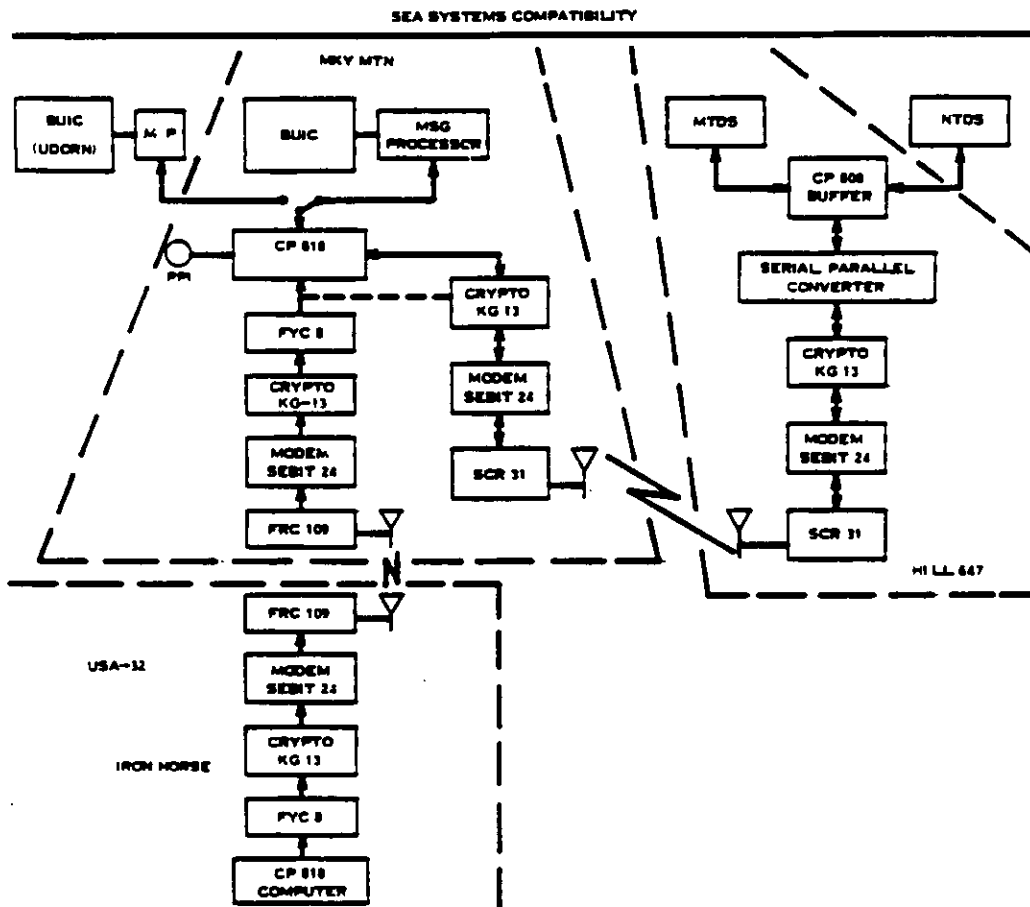

~~SECRET~~

GFDA-1

Exhibit A to
Tab D to
Annex F to
Appendix G

Central (TDCC)/Beach Buffer and Tactical Air Operations Center (TAOC).

(4) BUIC II/IRON HORSE/MTDS data will be interchanged with NTDS via a TADIL A data link to NTDS equipped ships in TF-77.

b. Data Flow

Inputs to the Air Force BUIC II system will initially be manual (July 1967) and then automatic (November 1967). The interface of systems will be as described below during these two phases of BUIC II inputs.

(1) Manual Input Phase: July 1967

(a) All data other than local radar will be input to the BUIC systems manually via punched cards. IRON HORSE data will be punched out on paper tape at TACC(NS) and converted to punched cards via an IBM 047 tape to card converter.

(b) Data interchange with TACC Udorn will be voice crosstell.

(c) IRON HORSE data will be fused with the MTDS and NTDS data in the TDCC CP-808 computer.

(d) The NTDS will receive from the MTDS TDCC data on those tracks which it does not hold or on tracks which it holds with a lower track quality.

(e) The MTDS TAOC will also receive track data from NTDS.

(2) Automatic Input Phase:

(a) Radar data inputs to the BUIC System will be automatic by Aug 67. Other inputs such as BIG EYE will continue to be manual pending Air Force modification of EC 121Ds or the replacement of the EC121D aircraft with EC121H (ALRI). IRON HORSE data will be automatically input to the BUIC System and fused by Nov 67. TACC Udorn and TACC(NS) will continue to exchange data via the data link.

(b) The fused BUIC/IRON HORSE data will be

~~SECRET~~

APPENDIX TO APPENDIX B

INTERFACE

1. (S) In the near future there will be four semi-automatic tactical control or data processing systems in Southeast Asia. The Marine Tactical Data System (MTDS) and the Navy Tactical Data System (NTDS) are interfaced by means of the MTDS Tactical Data Communications Central (TDCC). There is a requirement for the Air Force Tactical Data System (BUIC II/GSA-51) to be interfaced with MTDS/NTDS and IRON HORSE (IH). Exhibit A displays the elements of a compatible system.

2. (S) Based on these requirements, the involved services and agencies have evolved plans, concepts and specifications to implement the data exchange desirable. The Air Force ESD, has distributed their Interface Design Specification, Mitre Corporation Working Paper WF-1325 titled, "Automated Digital Exchange of Navy, Marine and Air Force Tactical Data Information In Vietnam (U)", dated 6 March 1967, for coordination. The IRON HORSE project office has distributed its Technical Development Plan dated 1 January 1967 for coordination. The Navy distributed their "US Navy Implementation Plan for Projects IRON HORSE/SEEK DAWN" for information and action to services/agencies concerned, on 9 March 1967.

a. Communications

(1) The IRON HORSE data will be introduced into the system via a TADIL B (JCS Pub 10) data link from the 6924th SS at Danang AB to TACC(NS) on Monkey Mountain.

(2) The Air Force data systems (BUIC II) will interchange digitized AF radar data as well as processed track data via data links between the TACC at Udorn and TACC(NS) on Monkey Mountain.

(3) BUIC II/IRON HORSE data will be interchanged with MTDS via a TADIL B (JCS Pub 10) data link between TACC(NS) and Hill 647, the location of the MTDS Tactical Data Communications

~~SECRET~~

GFD-1

Tab D to
Annex F to
Appendix B

~~SECRET~~

g. The scheme of operation presented above contains a number of problems which are currently being resolved:

- (1) The number of tracks to be reserved for each block.
- (2) The IH and Danang BUIC track number allocations.
- (3) The method of exchanging the M.O. (test) message.
- (4) The software implementation of the track management scheme presented.
- (5) The bit rate required for the TADIL B link to TACC(NS).
- (6) The mode, location and schedule of the interface check-out. (NTDS, ATDS and MTDS interface has already been checked out and is operational.)

~~SECRET~~

GFC-5

Tab C to
Annex F to
Appendix G

~~SECRET~~

b. The TDCC will report tracks generated by the ground environment systems to NTDS via TADIL A as if they had originated from a ship located at the common grid center. Specifically, X, Y coordinates reported in Message M.2 will be referred to the grid center. The TDCC will generate a message M.1 as the first message in each data report which for Δ latitude and Δ longitude reports the difference in latitude and longitude between the common grid center and NTDS grid reference point in increments of 1/16 minutes. (The NTDS grid reference point may be changed from time to time).

c. Track numbers are block allocated with at least 1000 numbers reserved for the ground environment systems. NTDS will require a specific block of 250 numbers. It would appear that the Udorn BUIC site should have a specific block. It would also appear that the Danang BUIC and the IH facility should have a combined track number block to avoid the isolation of IH tracks.

d. The M series message to be exchanged within the ground environment systems are M.0, M.2, M.82, and M.9. Message M.0 is a test message normally used within a system. Message M.2 will be implemented with interpretation bit (20) set to zero with bits 21-13 used for Track Quality. Message M.82 is implemented except for the BUIC/IH interpretation of the amplification of identity which is not resolved and Height Quality which is not implemented. Message M.9 is partially implemented. Bits 0-3 (message label); Bits 4-7 action, only drop track (zero) implemented; Bits 14-23 only zero (no statement) implemented; Bits 32-43 track number 1 implemented. This partial implementation is sufficient for track management. It may be desirable later to expand the inventory of joint messages to include M.5 (special points) M.6 (Electronic Warfare info) and M.10 and M.11 dealing with handover of aircraft, joint control of interceptors and status of interceptors. Initially, however, expansion of the inventory of joint messages might jeopardize the successful exchange of real time basic track information.

~~SECRET~~

GFC-3

Tab C to
Annex F to
Appendix G

EXHIBIT A TO TAB C TO ANNEX F TO APPENDIX G

MARINE TACTICAL DATA SYSTEM (INTEGRATED)

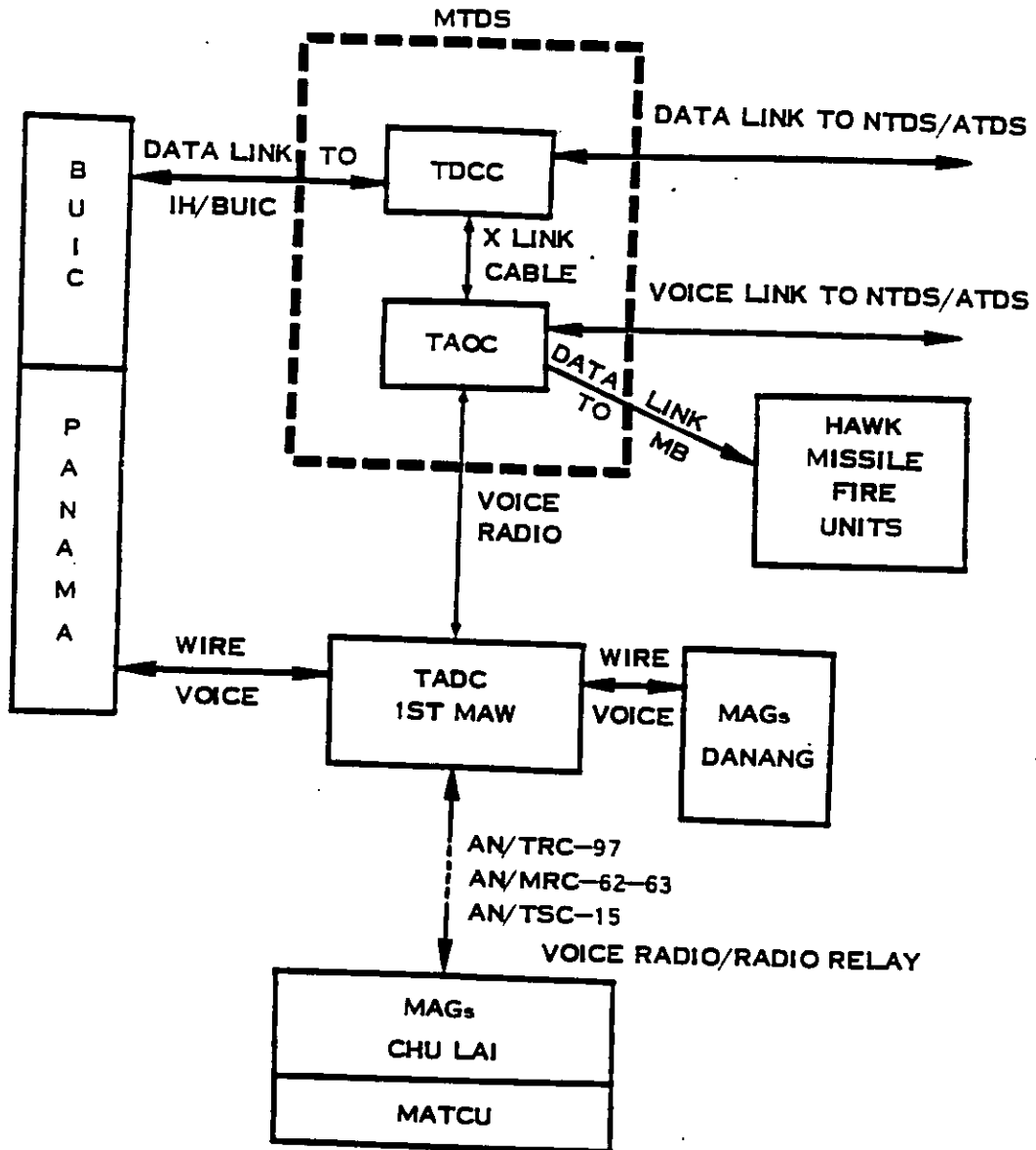

~~SECRET~~

TAB C TO ANNEX F TO APPENDIX G
MARINE TACTICAL DATA SYSTEM

1. (S) System Description

a. The Marine Tactical Data System (MTDS) provides facilities for the tactical control of aircraft for a Marine Aircraft Wing. The complete system is composed of a number of Tactical Air Operations Centers (TAOC), typically three, and a Tactical Air Command Center (TACC).

b. The TAOCs provide capability to conduct detailed air operations including the functions of detection, identification, and tracking of airborne targets, the assignment and control of interceptors, the coordination of SAM units, the assignment of air support aircraft to air support units and enroute air traffic control. The TACC provides facilities to present the over-all air situation to the Tactical Air Commander along with communications facilities necessary to command and coordinate the combat elements of the Marine Aircraft Wing. The TAOC may also function as an alternate TACC.

2. (S) Equipment and Deployment

a. Initially, at least, a single TAOC with additional equipment for data interchange between MTDS and NTDS/ATDS, less the MTDS - TACC, will be deployed in the Danang area (Exhibit A). The TAOC is an AN/TYQ-2 semi-automatic system. The additional equipment is a Tactical Data Communications Central (TDCC). This is an AN/TYQ-3 consisting of a General Purpose Computer (CP-808) with buffering equipment (AN/TYA-20), a kineplex modulation equipment (AN/TYA-17) suitable for Link 11 (TADIL A), and a HF transceiver group (AN/TYA-19).

b. The TAOC will be emplaced on Hill 647 during May 1967. This will provide the following capabilities:

(1) Automatic detection and acquisition of both IFF and non IFF targets out to a range of 250 miles (above the radar horizon).

~~SECRET~~

GFC-1

Tab C to
Annex F to
Appendix G

Information available to the computer program. The computer program shall provide data as requested by operator switch action, on the tabular display scope to supplement the information furnished on the situation display.

c. Error Recovery. The Tactical Air Program will provide a computer program which will automatically detect and isolate selected electronic failures internal to the AN/GSA-51. Information supplied by the error recovery program will be used by the startover function of the Tactical Air Program to determine the reconfiguration of the equipment in order to maintain an operating status.

d. Support Programs. Support programs will be provided for maintaining and testing the Tactical Air Program and for equipment maintenance diagnostic purposes. The support programs are divided into the following general categories:

(1) Utility Computer Programs. These programs are used in the assembly, checkout and modification of the Tactical Air Program.

(2) Simulation Computer Programs. These programs provide the capability of generating input data with which the AN/GSA-51 data processing set can be exercised both for training of operational personnel and system testing.

(3) Data Reduction Programs. These programs provide the capability for processing Tactical Air Program test data.

(4) Checkout Computer Program. The checkout program is a collection of programs, each of which checks a specific function of the AN/GSA-51 equipment. The checkout computer program provides a maintenance diagnostic capability for detection and isolation of an equipment fault to a specific area of an individual equipment module.

(11) Supervisory Control Equipment. Two card readers (Burroughs B-122) (only one card reader on-line at one time) and a Teletypewriter/Flexowriter (Friden) provide supervisory control over the AN/GSA-51.

(12) Manual Input Equipment. Four keypunches (IBM 026) and a paper tape-to-card converter (IBM 047) provide a means of preparing data to be manually input into the AN/GSA-51. These are off-line devices not directly connected to the AN/GSA-51.

8. (S) Computer Programs. An AN/GSA-51 will utilize operational and support programs. The operational program will assist personnel to perform the functions of air surveillance, tactical air control, and telling to other facilities. Support programs will be provided for use in maintaining the Radar Course Directing Group (AN/GSA-51).

a. Operational Program. The operational program, designated the Tactical Air Program (TAP), will be a collection of programs, sub-routines, and data tables which will perform the computations and data manipulations and provide for the display of data to assist personnel in accomplishing the functions of air surveillance, tactical air control, and telling. The Tactical Air Program will accept real-time inputs from external data sources, data display console operators, and manual input personnel and shall generate real-time outputs as a result of these inputs. It will accept, process, and display air situation and status data to support the directing, controlling, and monitoring of tactical air operations by controller personnel. Most of the functions performed by the Tactical Air Program have been described previously. Two additional functions are described in the subsequent paragraphs.

b. Displays and Switch Actions. The Tactical Air Program will make available track, geographic status, and radar data to pictorially depict on the situation display scope a representation of the air

SECRET

~~SECRET~~

computer words is provided on two magnetic drums with a capacity of 69,536 forty eight-bit words each.

(7) Message Processor/Data Link Buffer. The data link buffer provides the means for speed matching the high-speed digital computer to the relatively low-speed input and output circuits. It does this by controlling the receipt and transmission of serial digital messages over the digital data circuits by providing buffering storage registers where messages can be assembled into parallel words for the inputs and disassembled into serial words for the outputs.

(8) Data Display Console. Six data display consoles are provided. Each console consists of situation and tabular display tubes, display category selection switches, manual intervention switches, a light pen, activate switch, appropriate warning lights and audible alarms, writing table, storage area, and attached GFE communications equipment. The consoles are identical in design and capable of both one and two-man operation. The consoles are multi-purpose, capable of serving any of several functions, such as surveillance or weapons direction, under computer program control. Console switches are labeled in a manner to facilitate their change with a change in console function.

(9) Magnetic Tape. Three magnetic tape units (Burroughs B-422) and one magnetic tape controller are provided. Of the three tape units, one is normally used for auxiliary storage of operational and maintenance programs. The second provides a source of simulation data for training and testing. The third tape unit is normally used for the recording of data.

(10) Status Display Console. The status display console provides the facilities for monitoring the operational status of all elements of the AN/GSA-51 system (except the keypunch) at one console.

~~SECRET~~

GFB-13

Tab B to
Annex F to
Appendix 3

~~SECRET~~

- (5) 1 Typewriter-Punch Reader Set (AN/GYQ-2)
- 1 Typewriter-Punch Reader/Flexowriter (TI-398/GYQ-2)
- 1 Typewriter-Punch Reader Control (C-4638/GYQ-2)

- (6) 1 Punched Card Reader Set (AN/GSQ-72)
- 2 Punched Card Readers (MX-4735/GSQ-72)
- 1 Punched Card Feeder Control (C-4639/GSQ-72)
- 4 Key punch Machines (IBM 026)
- 1 Paper Tape to Punched Card Converter (IBM 047)

d. The following paragraphs contain a brief description of the major equipment elements of the AN/GSA-51.

(1) Data Processing Equipment. The Data Processor is a binary computer designed for highly reliable operation. It provides for the execution of a stored computer program, the storage of both data and instructions, and the program control of transfers between computer elements and external devices. It consists of three basic units: computer modules, core memory modules, and I/O control modules. These units are interconnected by a switching matrix which provides information and control paths between the core memory modules and the computer modules and between the core memory modules and the I/O control modules.

One each of the computer modules, core memory modules, and I/O modules are provided for redundancy which allows the high reliability required of the AN/GSA-51 subsystem to be achieved. These modules are not normally used by the tactical air function. Under control of the operational computer program, the backup modules may be substituted for another module of the same type that has failed.

(2) Computer Modules. Two computer modules control the functions of the AN/GSA-51 by exe-

~~SECRET~~

GFB-11

Tab E to
Annex F to
Appendix G

is a solid state, special purpose data processor which receives search and beacon video and converts this information into a series of discrete digital messages. A statistical detection of the leading and trailing edges of the radar return sequences in a particular range increment is made on a series of successive trigger pulse intervals. Returns which meet specific detection criteria are classified as targets and undergo further processing to determine the approximate center azimuth of the target return sequence. In addition to the above processing steps beacon video is subjected to SIF code processing for Modes I, II, and III and Code C. (Mode V). Beacon video returns are decoded to extract the SIF code. Code validation is accomplished by a code comparison of two successive returns of the same SIF mode. The SIF interrogation mode is varied from scan to scan to permit the reporting of codes for each of the three SIF modes. A digital message is then composed which contains the range and azimuth of the target, in polar coordinates, the SIF code for a beacon target, and other supplementary information concerning the target.

b. AN/GSA-51

The AN/GSA-51 performs the following functions:

- (1) Accepts input information in digital form from external sources.
- (2) Performs all necessary internal calculations and data manipulations required by the stored computer program.
- (3) Prepares displays and transmits display information to the appropriate display consoles.
- (4) Accepts and processes manually-inserted information and operator switch actions.
- (5) Stores appropriate information recorded by the computer program.

d. Interceptor Guidance. Guidance calculations for manned interceptors will be made using double turn guidance logic as in the BUIC II system (CONUS). Interceptors will be employed using a standard long range profile. The parameters of the profile may be changed by an operator with the console switches. There are four manned interceptor attack options:

(1) The Stern Attack, a one or two point offset geometry culminating in a lead pursuit course.

(2) The Beam Attack, a final-turn lead collision course ending in a beam approach.

(3) The Front Attack, either a pure lead collision course or a final turn lead collision course ending in a frontal approach.

(4) The Cut-Off Attack, a pure lead collision course.

e. Information Transfer

The AN/GSA-51 facilities will be capable of exchanging computer processed track information and other data via digital data link. The selection of data to be exchanged is controlled by operator personnel. Equipment Descriptions and Computer Programs supporting these functions are outlined below in paragraph 7. Communications which support the automated TACC(NS) are outlined in paragraph 3, Annex D.

7. (3) Equipment Descriptions.

The following paragraphs present a brief description of the AN/GSA-51 and AN/FYQ-40 equipment.

a. AN/FYQ-40

Search and beacon radar data from AN/FPS-20 radars at the Udorn and Danang facilities shall be processed by collocated AN/FYQ-40 Common Digitizers (CD) for digital transmission to the AN/GSA-51 data processors at the primary and alternate TACCs. The CD

~~SECRET~~

graphic track will also be processed by the computer.

a. (C) Procedures

a. Identification. The identification function provides for the identification of tracks established by the tracking function. Identification, apart from IFF/SIF, will be primarily a manual operation involving the judgement of a display console operator. Air movements data (AMD) representing friendly aircraft flight plans will be provided to aid in the identification task. Friendly and hostile tracks will be identified by an ASO and the identification inserted into the computer by use of console switches. Interceptor tracks are automatically identified by the computer. The identity of all system tracks will be monitored at a pictorial display and changes made at any time in accordance with established procedures through coordination among the responsible operators.

b. Tactical Control. In addition to the monitoring of the air situation through information provided by the air surveillance functions, the system will have a capability to control and vector up to 20 tracks to specific fixed targets. Control includes the direction of aircraft by operator personnel utilizing voice communications and the preparation and display of guidance instructions by the computer. Operator personnel will coordinate the instructions on tracks to be passed to adjacent facilities and will monitor these tracks as they pass through the area.

c. Interceptor Commitment. Manned interceptors may be; (1) guided to tankers for refueling missions; (2) committed on intercept missions directly against either fixed targets or hostile aircraft; or (3) they may be committed to Combat Air Patrol (CAP) for subsequent airborne commitment against hostile aircraft. Interceptors may be committed in groups against mass raids. Profiles for both F-102 and F-4 aircraft have been included in the Computer Program.

~~SECRET~~

GFB-7

Tab B to
Annex F to
Appendix C

can take on minor support or independent roles upon request, thereby reverting to Mode I and Mode II.

d. Mode IV will utilize only one facility and will be required when one of the AN/GSA-51s is down for any reason.

5. (S) Equipment Functions

The AN/GSA-51 will function as follows:

a. Radar Inputs. Long range search and beacon (IFF/SIF) radar data will be provided to each facility from long range radars at Udorn and Monkey Mountain CRCs. The Common Digitizer (AN/FYQ-40) output at the radar sites will be connected to each facility independent of the AN/GSA-51 processing system. Data will be received automatically from the two long range radar sites via a digital-data network. The data will contain SIF modes I, II and III and associated codes and search positional data. This data will be presented on a pictorial display of the area of responsibility. A "trail" of data received over several successive radar scans indicates the probable existence of an aircraft that can be tracked.

b. Automatic Tracking. Each AN/GSA-51 will be capable of automatically tracking up to 120 tracks. Each track may be based on radar data or manual input information. Initiation of new tracks on aircraft data trails will be accomplished by an Air Surveillance Operator (ASO) with the display console light pen and switches. Once a track has been initiated, correlation of data, position and velocity smoothing, and position prediction will be accomplished automatically. Special displays and switches will enable the system operators to monitor the tracking function and take corrective action when necessary.

c. Manual Inputs. The AN/GSA-51 will accept and process manually inserted track data inputs received from AEW&C aircraft, non-digitally netted radar sites, and other sources. The computer will process manually inserted updating information, such as flight plans, and indications of hazardous geo-

~~SECRET~~

(6) The WD will be concerned with the actual mission objective, alerting the flight to any hostile aircraft in the area or upon approaching the border, or of any unplanned changes in procedures. Guidance to the target may be provided through use of computer generated commands. The WD would then communicate with the flight on an as required basis.

(7) The flight position may be lost when the aircraft attack the target at low level. When the aircraft leave the target area, the ASO and WD will quickly re-establish the location of the flight, based on the best source of data available.

(8) If an aircraft goes down, the WD will initiate appropriate recovery procedures, insuring that the computer marks the last known position by inserting a manual input zero-velocity track. Recovery aircraft will then be guided to the downed aircraft by the WD using computer generated guidance data.

(9) Flights will be monitored by the ASO and WD during return to base in the same fashion as on the way to the target. The return to base can be handled by either the prime or alternate facility and will be decided on a real-time basis by the SD.

b. Mode II will allow the two BUICs to operate independently of each other. Minor missions will be delegated to the alternate facility to perform. Major missions will still be performed by the primary facility. Also unusual weather or communication equipment problems could prevail that would make it desirable to split operations between the two facilities.

c. Mode III will utilize the primary BUIC II facility as the operational site with the alternate facility as backup. In this mode the alternate facility would merely maintain a current air picture and be ready to take over the mission in case of any problems. Also, in this mode the standby

~~SECRET~~

GFB-5

Tab B to
Annex F to
Appendix G

~~SECRET~~

providing the best possible position estimates of the flights of aircrafts based on the data sources available at any one time.

(3) Aircraft departing from airbases within radar coverage will be detected as data trails on the operators' consoles. Association of a computer track with the data trails will be performed by the ASO. One computer track will be associated with a flight of close formation aircraft. ASO and WD personnel will cross-check flight plan information with actual flight positioning, heading, and SIF data by use of appropriate switch actions and displays.

(4) Aircraft requiring refueling before heading for a target will be monitored as they approach the tanker. WD personnel will commit the flight aircraft against the tanker by switch action and obtain guidance information using the available stern approach tactic. The guidance data (commanded heading, range and bearing) will then be available at the console for use by the WD as required. Aircraft departing from Thailand will probably be controlled by the alternate facility up to this point because of the closer proximity to the aircraft and shorter ground-to-air communication range. The primary facility will pick up the flight after refueling.

(5) The ASO will watch for the transition from long range radar coverage. When the flight is outside of coverage, the ASO will have the computer extrapolate the track. Discrepancies between the extrapolated track, and available NFDS, BIG EYE, and IRON HORSE position and heading data with the flight plan will be noted and compared. The best source will be chosen for the actual track position and the computer informed by switch action. The computer will then update the track position based on the source selected. The ASO will monitor all available sources throughout the mission and position the flight using the positional data available at the time.

~~SECRET~~

GFB-4

Tab B to
Annex F to
Appendix G

~~SECRET~~

will have identical equipment to the TACC(NS) Monkey Mountain and will have complete operational capability in the event that TACC(NS) becomes inoperative. If TACC(NS) goes down, the communication net will allow the alternate TACC(NS) complete access to BIG EYE, IRON HORSE, NTDS, 7th AF CP, and the Monkey Mountain CRC. All long haul communication links are programmed to use the Integrated Wide Band Communication System (IWCS), as outlined in paragraph 3.b., Annex D, Appendix G.

4. (3) Operation

The BUIC II equipment will be operated in one of four possible modes, depending upon the mission requirements and equipment status at the time.

a. Mode I (Primary Mode) will utilize both BUIC II equipment sets for a mission. The prime facility will maintain overall control, but certain functions will be delegated to the alternate facility. The functions may be monitoring aircraft returning to base, vectoring aircraft for refueling, or vectoring rescue aircraft. Under this mode of operation each TACC facility will be receiving radar data from both radar sites at Monkey Mountain and Udorn. All data from BIG EYE aircraft, IRON HORSE, NTDS and other intelligence sources will feed into the prime facility at Monkey Mountain.

(1) Aircraft flight plans will be prepared from frag orders and inserted into the computers via the card reader. The flight plans and identifying information (SIF code and squadron identification) are then available to all console operators.

(2) The console operators will be divided into three teams of operators. Each team will contain an Air Surveillance Operator (ASO) and a Weapons Director (WD). One of the WDs would be the Senior Director (SD) responsible for the coordination and control of the mission. Each team will be assigned specific flights of aircraft based on geography and/or aircraft mission. Each ASO will be responsible for

~~SECRET~~

GFB-3

Tab B to
Annex F to
Appendix G

~~SECRET~~

range radars at Monkey Mountain and Udorn will be processed and displayed automatically and all other inputs will be entered manually and processed for display. The SEEK DAWN management plan schedules completion of the interface between BUIC II and MTDS/NTDS for second quarter FY 68. Upon completion of the interface, two way automated exchange of selected data between all three systems will be possible. By the second quarter FY 68 IRON HORSE will be providing digitized supplementary tracking data which will also be accepted and automatically processed.

2. (S) Facilities

Facilities to house the AN/GSA-51, the AN/FYQ-40, and a major portion of the communication equipment, are being constructed at Monkey Mountain and Udorn. Three prefabricated buildings are being constructed at Monkey Mountain. One building will house the AN/GSA-51 and communication equipment. Another building will house the AN/FYQ-40 equipment and spares for all equipments. The third building will contain diesel generators to provide power for the installed equipment. Two prefabricated buildings are being constructed at Udorn. One building will house the AN/GSA-51 and AN/FYQ-40 communications and spare equipment. The other building will contain diesel generators for providing power to the installed equipment. Both facilities will be operated by personnel experienced with the BUIC II system. Prior to their departure for Southeast Asia, the AN/GSA-51 operators will receive orientation to familiarize them with the TACC(NS) operation. The total manpower for both sites to operate and maintain equipment, including communications, will be somewhat over 200 personnel.

3. (S) Command and Control

Command and control of TACC(NS) will be exercised through the Battle Commander. Console positions will be manned by a Senior Director, Weapons Directors, Air Surveillance Operators, and additional technicians required for the conduct of operations. Liaison with other tactical systems and services will be available to the Battle Commander. Tactical aircraft guidance and control will be conducted by the Senior Director and Weapons Directors over voice links. The alternate facility at Udorn

~~SECRET~~

GFB-2

Tab B to
Annex F to
Appendix G

L E T T E R S L E T T E R S L E T T E R S L E T T E R S L E T T E R S

~~SECRET~~

TAB B TO ANNEX F TO APPENDIX C
USAF BUIC II SYSTEM

1. (S) General

a. The present manual data system for command and control of USAF forces and coordination with other elements (Navy, USMC, NSA) is being replaced with a semi-automatic system (BUIC II) prior to the end of FY 67. At this time, the system will provide a capability for centralized area control of tactical aircraft utilizing automated inputs from integral radars and manual inputs from BIG EYE, NTDS, MTDS and special intelligence sources through a semi-automatic data processing capability. The system will be comprised of two AN/FYQ-40 Common Digitizers digitally tied to each of two AN/GSA-51 Radar Course Directing Groups plus associated equipment. The AN/FYQ-40 equipment will receive beacon and search radar video from existing long range radars and will transmit digital target data. The AN/GSA-51 equipments will be digitally tied so as to exchange information on tracks. The prime centralized control facility (TACC(NS)) will be located at Monkey Mountain utilizing the AN/GSA-51; and the alternate facility (ATACC(NS)), will be at Udorn, Thailand. The system will receive automated inputs from long range radars at Danang, Republic of Vietnam, and Udorn, Thailand. In addition, it will process track information which has been manually introduced from the Naval Tactical Data System (NTDS), Marine Tactical Data System (MTDS), IRON HORSE and airborne radar platforms. Correlation of track information with prefiled flight plans and other manual data will allow personnel to construct and monitor the tactical air situation over North Vietnam, by use of the data display subsystem.

b. During FY 67, the BUIC II system is scheduled to be installed at Monkey Mountain and Udorn. Within this time frame the computer interface with MTDS/NTDS will not be complete and the IRON HORSE equipment will not be in place. As a result the input from the long

~~SECRET~~

GFB-1

Tab B to
Annex F to
Appendix C

~~SECRET~~

b. Operating as a unit of a combat information center (Link 11) with other ATDS aircraft, NTDS ships and NTDS installations, the ATDS aircraft automatically exchanges track information under the same constraints and procedures as NTDS units.

c. The ATDS computer is currently a drum and therefore lacks the flexibility for changes existing in the NTDS general purpose computer. However, the drums can be, and are, reprogrammed periodically to incorporate new doctrine and additional mutually agreed upon information.

d. The ATDS aircraft are embarked as four plane detachments aboard NTDS equipped CVAs. These aircraft are currently operating in TF-77, adding significant capabilities and extension of the fleet surveillance area. Netted by Link 11 with the PIRAZ picket ship, positive identification of aircraft in the area is being realized. ATDS aircraft on station also participate in the vectoring of strike aircraft to targets.

~~SECRET~~

GFA-6

TAB A to
Annex F to
Appendix B

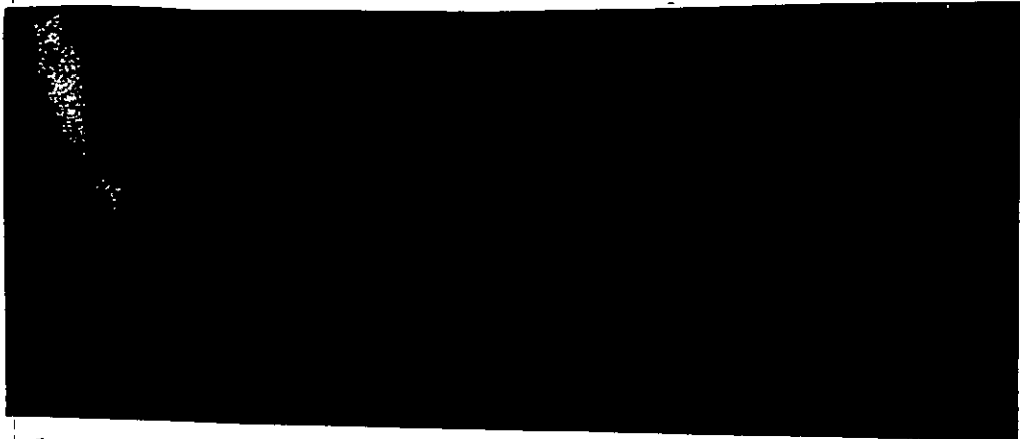

Track reporting responsibility within the NTDS/ATDS or ATDS complex is controlled automatically by a comparison of track quality - a measure of each unit's tracking confidence level. The unit with the highest track quality reports the track. Correlation of different track numbers is done normally by operators. Identity conflicts are also handled normally after coordination over voice circuits.

4. (S) Airborne Tactical Data System (ATDS)
Description

a. ATDS is an airborne early warning system specifically designed to perform two primary missions in fleet anti air warfare. early warning and intercept control. ATDS is made up of:

- (1) The aircraft (E-2A)
- (2) Data gathering sensors (radar, IFF, navigation and communications equipment)
- (3) Data processing and display equipment
- (4) Data transmission equipment (Link 11, Link 4)

The ATDS aircraft essentially functions as an airborne picket operating in the fleet air defense complex at 35,000 feet with a capability to do air battle direction.

~~CONFIDENTIAL~~

synchronous phase quadrature modulation. This equipment transmits, and receives, thirty bits of data, the computer word length, in parallel at a data rate of 1367 or 2250 bits per second. When HF carrier frequency is used, the range is 300 miles. For line-of-sight operations, UHF can be used. The error rate in clear environment is less than one bit in 10^7 .

e. NTDS Data Transfer to Non-NTDS Units. Since NTDS units must work in consort with non-NTDS units, provision has been made to utilize the standard radio teletype communication circuits aboard ship. The computer is connected directly to the teletype circuits by means of an adapter which is fabricated into the base of the AN/UGC-13 or 16. This provides the parallel to serial conversion of the data and the addition of the necessary timing codes for proper teletype operation. NTDS units operate on a broadcast mode to non-NTDS units. This link is designated Link 14.

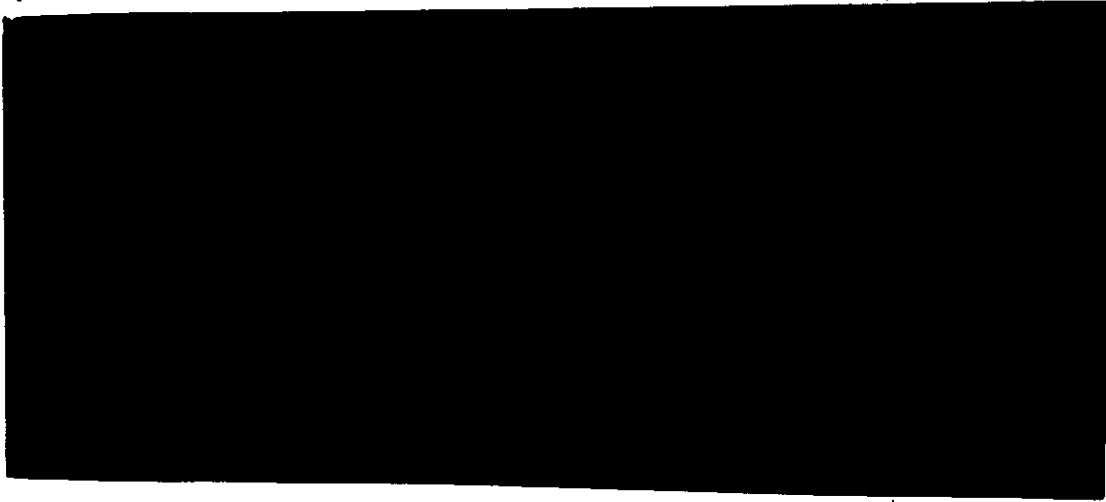

~~CONFIDENTIAL~~

GFA-4

Tab. A to
Annex F to
Appendix G

b. The computer is designed and constructed to withstand severe shock and vibration of the shipboard environment. Housed in a single cabinet measuring 37 inches deep, 37 inches wide and 72 inches high, the mean time between failure has been demonstrated to be greater than 2000 hours. The computer is repaired by replacing circuit cards. The faulty card is then disposed of. Five memory modules are horizontally arrayed within the cabinet. Logic modules are encapsulated printed-circuit cards which plug into the trays. Maintenance test points are readily accessible at the front of the trays. Other data processing equipment includes:

- (1) The magnetic tape unit
- (2) The paper tape unit
- (3) The system monitoring panel
- (4) The keyset system
- (5) The interconnection panel

c. Since the prime purpose of NTDS is to provide improved information services and a better tactical tool for command, great emphasis has been placed on the man to machine relationship in the design of the displays. The present production models also incorporate the latest advances in electronics micro miniaturization. The size and form factor are dictated primarily by human engineering considerations. The console is a multi-purpose device having 32 functional modes of operation. Raw radar or sonar information is presented on the direct view PPI along with computer generated and positioned symbols. Additional alpha-numeric information is presented on a matrix of projection readouts. As an example of the equipment flexibility, one operational mode provides a TV raster instead of the usual PPI indication.

d. NTDS is a multi-computer/multi-site system. The direct intercomputer data transfer on a real time basis is an essential feature of the system. The primary real time target data link uses

~~CONFIDENTIAL~~

TAB A TO ANNEX F TO APPENDIX G

NAVAL TACTICAL DATA SYSTEM

1. (C) General.

a. Naval Tactical Data System (NTDS) is a high capacity, multi-computer, multi-site data AAW/tracking system designed for installation and operation aboard ships. The primary function of the system is high speed track identification and interception of friendly and enemy air and surface radar contacts. The information is computer processed and displayed. Included is the means for real time inter-computer target data transfer among ships. It performs many of the functions required of combat direction systems in ships of the fleet. The system greatly increases the volume of tactical data that can be collected and evaluated, thereby increasing the effectiveness of both individual ships and multi-ship forces.

b. Status. NTDS is now operational in the fleet. It is installed in 17 ships; six CVAs, nine DLGs and two CGs. Three additional installations are scheduled for this fiscal year and a total of 36 installations are planned and budgeted by fourth quarter FY 1969. By 1971, it is planned that all CVA and DLGs plus others will have the NTDS installed.

c. NTDS coordinates the collection of data from sources aboard ship and from external sources using communication links; correlates the data to obtain a clear picture of the tactical situation; processes and displays the data as required for decision-making; and communicates the decision for action to the selected weapons control system. NTDS is concerned with all major categories of naval operations. Specific functions undertaken by NTDS, depending on ship type and mission include:

~~CONFIDENTIAL~~

GFA-1

Tab A to
Annex F to
Appendix G

at TACC (NS). With the availability of the MTDS Beach Relay System in the Danang area the interface is clearly feasible and within our technical capability. However, since many agencies are involved, obtaining coordination and agreement between the agencies on the overall system of implementation is currently a major management problem.

4. (S) Status. Completion [REDACTED] involves reaching agreement between USAF, USN, USMC and NSA on program specification for system compatibility. A draft plan is now in circulation among the appropriate agencies for concurrence proposing interface specification. When a plan has been agreed upon, the following must be accomplished: statement of work; development of specifications for equipment interface, software, and overall test; system test, integration and check out planning; and award of contracts as necessary.

5. (S) The Naval Tactical Data System, the USAF BUIC system and the Marine Tactical Data System are described in TABS A, B and C respectively. The plan to interface these systems at Monkey Mountain is discussed in TAB D.

~~SECRET~~

t. CSAF in November 1966 directed AFSS to provide and maintain the communication packages required to permit secure voice and/or data transmission from Danang Air Base to the TACC (NS), TACC Udorn and the 7th AF Command Post. Further, AFSS was requested to identify communication channels required and to provide maintenance personnel to maintain the IRON HORSE equipment at the TACC (NS) and 7th AF Command Post.

u. On 1 December 1966, during a meeting of CSAF, CNO, ESD, USMC and NSA representatives, it was agreed the final data exchange configuration would permit IRON HORSE to be one of several inputs to the BUIC at TACC (NS) and the MTDS/NTDS would exchange data directly with BUIC without a normal direct interface with IRON HORSE. However, in the event BUIC is not in operation, an IRON HORSE/NTDS interface capability will be provided. The need for an overall manager/executive agent for integration and implementation of the three systems was identified.

v. The Southeast Asia site survey was completed by the USAF and site concurrence received from VNAF CRC commander on 16 December 1966.

w. On 31 December, ESD issued the SEEK DAWN (416P) management plan.

x. On 10 February 1967, representatives of ESD, AFCS, AFSS, GEEIA, NEL, MITRE, SDC and NSA met at the MITRE Corporation and formulated a coherent plan for the SEEK DAWN/IRON HORSE interface. Agreements were reached on equipment configurations, message formats and software responsibilities.

3. (S) Interface. Fundamentally, the BUIC II and NTDS were not designed as compatible systems. Compatibility between the systems can be achieved by use of proper interface buffer equipment. The interface buffer equipment selected for use between BUIC II and NTDS is the Beach Relay System of the MTDS, provided with proper programming and required ancillary equipment such as serial parallel converters, required transmission links (either wire or radio), and the IRON HORSE 818 computer

~~SECRET~~

GF-6

Annex F to
Appendix G

~~SECRET~~

Control Center designated the TACC (North Sector). CINCPAC requested follow-on action to be taken to ensure compatibility of equipment and systems. Another conference was held at PACAF Headquarters on 29/30 August with participation of representatives from PACAF, PACFLT, CINCPAC, CSAF, CNO, AFSS, NSA, NSAPAC, PSR, NSGPAC, and JSPC. A three-phased approach to the establishment of the TACC (NS) was developed which included on-line interface between USAF/USMC/USN tactical data systems and IRON HORSE.

1. CNO designated the Navy portion as project IRON HORSE, QRC-67-4, Category II on 22 September 1966. Action and funding to procure communication security equipment for LINK 11 had been initiated previously.

m. On 27 September 1966, 7th AF issued SEAOR 67-1-FY-67 in support of COMBAT LIGHTNING.

n. On 18 October, CNO and CMC representatives informed NSA that a Marine Corps Tactical Data System (MTDS) Tactical Air Operations Center would be collocated with the MTDS beach relay.

o. On 20 October 1966, 7th AF issued Programmed Action Directive 67-8: Activation of North Sector Tactical Air Control Center - TACC (NS).

p. On 22 October, 7th AF issued the Concept of Operations for TACC (NS), (COMBAT LIGHTNING).

q. On 1 November, 7th AF issued Operations Plan 67-1-FY-67, "COMBAT LIGHTNING."

r. Early in November CSAF accepted the ESD/MITRE recommendation that the Tactical Data Systems to be installed at Udon and Monkey Mountain be AN/GSA-51s (TDC II).

s. On 16 November, Project SEEK DAWN was established via message from AFRDQRC. This project is that portion of Project COMBAT LIGHTNING which is responsive to SEAOR 67-1-FY-67 and includes the installation of the AN/GSA-51s.

~~SECRET~~

GF-5

Annex F to
Appendix G

~~SECRET~~

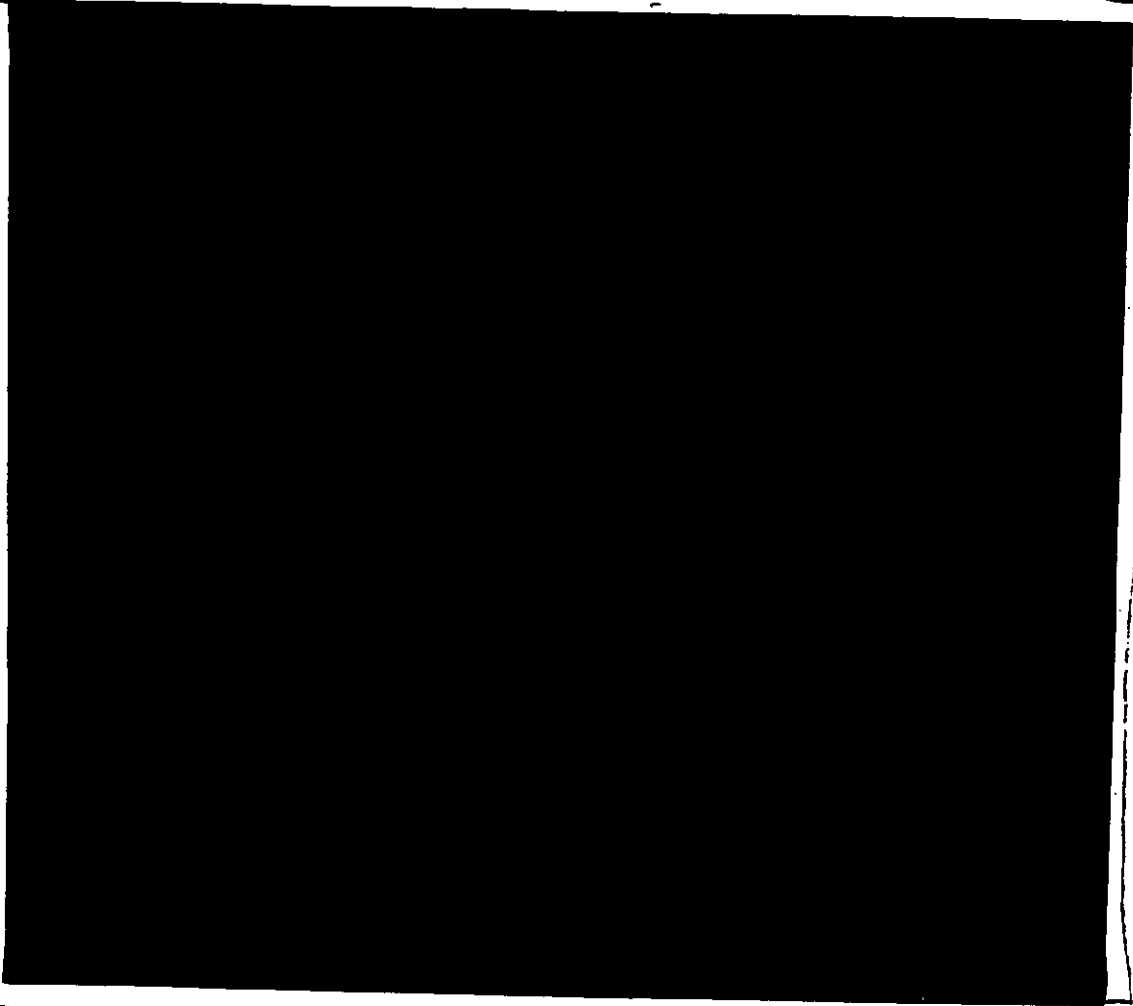

i. As a result of the 12 May and 29 June 1966 border violation incidents, and the subsequent investigations, recommendations were made to upgrade US air control and warning capabilities over North Vietnam. This resulted in the USAF COMBAT LIGHTNING, US NAVY FIRAZ, and associated programs.

j. On 26 July, CSAF (EDORF) stated an urgent requirement for IRON HORSE data and cited the need for five display consoles. Four were to be located at CRC Panama and one at 7th AF/TACC.

k. A conference was held in Hawaii during August 1966 during which PACAF presented the Air Force's proposal for establishing a USAF NVN Operations

~~SECRET~~

GF---

Annex F to
Appendix G

(4) Upgrade of the USAF semi-automated system (BUIC II) to include local and remote radar data input; on-line data interchange between TACC(NS) and Udorn, increased track capability, and automatic SIF readout.

(5) Establishment of on-line data interchange link between NTDS/MTDS and IRON HORSE.

(6) Receipt in theater of three additional radio relay aircraft (KC-135s).

In the third phase, September 1967 to March 1968, improvements will include the following:

(1) Establishment of an on-line data interchange link between the USAF system and NTDS/MTDS and IRON HORSE.

(2) Commencement of installation of secure voice communications in tactical aircraft via KY-28 equipment (Project SEEK SILENCE).

2. (S) History

a. On 3 November 1965, the Office of the Secretary of Defense, Director of Defense Research and Engineering (DDR&E) requested [REDACTED]

[REDACTED] in support of 7th AF and 7th FLT and, if feasible, to identify and cost out the equipment. A reply was requested within ten days to enable inclusion of the funding in the January FY 66 supplemental budget.

c. The Air Force has initiated a program (COMBAT LIGHTNING) for similar purposes. This program involves a phased improvement of the 7th AF capability to control USAF aircraft over North Vietnam. In the first phase, October 1966 to April 1967, improvement includes the following:

(1) Communications with tactical aircraft via ARC-89 airborne radio relay equipment. Two KC-135s are now in theater (LUZON/WAGER).

(2) Establishment of a separate command and control facility, TACC (NS), adjacent to the joint USAF/VNAF Control and Reporting Center (Panama CRC) on Monkey Mountain. TACC (NS) has responsibility for USAF aircraft over North Vietnam less RP I; Panama CRC has responsibility for aircraft in RP I, Southern Laos, and the I Corps area of South Vietnam. [REDACTED]

(3) Upgrade of communications and communications security for the crosstell of tracking data.

(4) Stationing another BIG EYE aircraft over Laos to increase aircraft tracking capability.

(5) Commencement of secure voice communication with tactical support aircraft via KY-8 equipment. (SEEK SILENCE, formerly ANGEL VOICE)

In the second phase, April 1967 to September 1967, improvements will include the following:

(1) Installation of IRON HORSE at [REDACTED] with an interim console display or print/punch capability installed at TACC (NS).

(2) Upgrade of the IRON HORSE installation at TACC (NS) to a computer with two displays.

(3) Installation of the USAF Tactical Data System, BUIC II (SEEK DAWN), at TACC (NS) and Udorn with automatic, digital tracking data input capability.

~~SECRET~~

ANNEX F TO APPENDIX G

[REDACTED] US AIR CONTROL AND
DATA PROCESSING SYSTEM IN SOUTHEAST ASIA

1. (S) Background

a. Tactical air Commanders in Southeast Asia have a continuing requirement for the best available tracking data on aircraft activity over North Vietnam. Since November 1965, [REDACTED]

TF-77 receives this data, as well as USAF tracking data, through normal crosstell. IRON HORSE is the code name of a program to improve on HAMMOCK by automating the processing and forwarding of supplementary data. IRON HORSE will provide:

- (1) A larger volume of data
- (2) More timely data
- (3) Better quality data

b. Both the Air Force and the Navy are making every effort to improve direct tactical control of aircraft over North Vietnam. It is highly desirable to be able to control tactical aircraft by call sign over North Vietnam. The most important tactical improvement will be in refinement of SAM, MIG and CHICOM border warnings, which can be issued more precisely to the affected aircraft. The Navy has located an NTDS equipped ship (cruiser or destroyer type) within five nautical miles of 19-37N and 107-47E in the Tonkin Gulf. It has been designated the Positive Identification Radar Advisory Zone (PIRAZ) ship. The mission is to provide positive identification of all aircraft entering, operating within, or leaving the designated zone; provide advisory control to aircraft in the zone upon request utilizing all means available; provide maximum early warning of impending hostile air action against friendly air and/or surface units; and take under attack those identified hostile aircraft and/or surface units as directed and destroy in accordance with rules of engagement.

~~SECRET~~

GF-1

Annex F to
Appendix G

DISTRIBUTION

~~SECRET~~

~~SECRET~~

CINCPAC.	4	CINCPACFLT	2
CINCPACAF.	10	COMSEVENTHFLT.	2
COMUSMACV.	4	CTF 77	5
AFGP	2	CTG 77.9 (SSSC Turnover File).	1
7 AIR FORCE.	8	CTU 77.0.1 (SAR DD Turnover File).	5
DEP COMDR 7/13 AF.	2	CTU 77.0.2 (PIRAZ Turnover File)	2
3rd TAC FTR WG	6	COMCARDIV ONE	1
8th TAC FTR WG	5	COMCARDIV THREE.	1
12th TAC FTR WG.	5	COMCARDIV SEVEN.	1
35th TAC FTR WG.	5	COMCARDIV NINE	1
355th TAC FTR WG	7	CTG 70.4	1
366th TAC FTR WG	5	CTG 70.8	1
388th TAC FTR WG	6	USS TICONDEROGA (CVA 14)	1
460th TAC RECON WG	12	USS HANCOCK (CVA 19)	1
630th CMBT SPT GP.	5	USS BON HOMME RICHARD (CVA 31)	1
631st CMBT SPT GP.	2	USS ORISKANY (CVA 34).	1
634th CMBT SPT GP.	2	USS MIDWAY (CVA 41).	1
635th CMBT SPT GP.	2	USS CORAL SEA (CVA 43)	1
3rd ARR GP	2	USS RANGER (CVA 61).	1
BIG EYE TASK FORCE	2	USS KITTY HAWK (CVA 63).	1
97th ARTILLERY GP.	1	USS COMSTELLATION (CVA 64)	1
505th TAC COM GP	5	USS ENTERPRISE (CVA 65).	1
619th TAC COM SQ	10	CTE 70.2.1.1	1
620th TAC COM SQ	5	CTE 70.2.1.2	1
621st TAC COM SQ	10	CTE 70.2.1.3	1
5th AIR FORCE.	2	CG 1st MAW	8
13th AIR FORCE	2	VMCJ-1	1
3rd AIR DIVISION	2		
41st AIR DIVISION.	2	File	8
DET-1, 41st-AIR DIV.	2		

TOTAL

190

GEA-11

Tab A to
Annex E to
Appendix G

- (f) SAR unit location and assistance.
- (g) Combat Air Patrol (CAP) assistance, when available.
- (h) Communications relay.
- (i) Handoff to other control facilities.
- (j) Tanker location and information.

(3) Location:

(a) The PIRAZ Unit will normally maintain station within 5 nm of 19°37'N - 106°47'E.

(b) The PIRAZ Unit will periodically leave station to replenish. The frequency of replenishment will be determined by the type unit assigned and the availability of replenishment forces. The PIRAZ Unit will promulgate a message to all concerned, including 7th Air Force, indicating the estimated time of departure from station and the expected time of return to station.

(c) During the period while the PIRAZ Unit is off station, CTU 77.0.1, the SAR Team Commander, will insure that a suitable unit is at the PIRAZ station or the Northern SAR Station to maintain continuous surveillance.

11. (U) Responsibilities: The Commander 7th Air Force and Commander Task Force 77 will insure that all applicable Operations Orders and Fragmentary Orders are transmitted to the opposite service for missions in which both services will participate.

12. (U) Communications: Information exchange pursuant to this agreement shall be by means of normal communications channels defined in 7AF OPOD 100-67, CTF 77 OPOD 320-66, and other pertinent directives.

~~SECRET~~

Commander 7th Air Force and CTG 77.0 with CTF 77 an information addressee. Each request will fully substantiate the requirement for exemption from the established procedures. CTG 77.0 will advise 7AF of approval or disapproval of requests for missions which will over-fly the Task Force. 7AF will inform the unit concerned of approval or disapproval of the requested mission. The unit conducting an approved mission must provide sufficient data for proper identification of the flight(s) throughout the mission. Flight data required for identification will be submitted by message to the 620 Tactical Control Squadron, Danang AB, RVN (unit designator of Panama CRC), 7AF, CTG 77.0 and CTU 77.0.2. Flight data messages must be disseminated sufficiently in advance to assure receipt by all addressees prior to the conduct of the mission.

g. Facilities, Services and Location of the PIRAZ Unit:

(1) Facilities: CTF 77 shall maintain a suitably configured ship, preferably a Cruiser or Destroyer Leader on PIRAZ station. The ship shall, if possible, be equipped with:

- (a) Navy Tactical Data System (NTDS).
- (b) Long range air search radar with moving target indicator (MTI).
- (c) Height finding radar.
- (d) UPA 49/50 direct IFF/SIF readout equipment.
- (e) TACAN (Channel - 26; Identifier - Alfa Romeo).

(2) Services: The PIRAZ ship, Red Crown, shall provide the following services upon request:

- (a) Air Intercept Control (GCI).
- (b) Navigational assistance.
- (c) Advisory control of aircraft.
- (d) Flight following.
- (e) Assist in rendezvous (join-up of aircraft).

~~SECRET~~

GEA-8

Tab A to
Annex E to
Appendix G

~~SECRET~~

(3) Panama CRC will identify mission aircraft entering the PIRAZ from the south by providing Red Crown with voice call sign and position as the aircraft proceed north into the Gulf of Tonkin area and prior to the aircraft passing 18°30'N.

(4) Mission aircraft entering the PIRAZ from the west, north of 18°30'N (30 miles from coast) shall call Ethan and Red Crown when entering. Mission aircraft outbound from the target area toward the Gulf of Tonkin area north of 18°30'N will check in with Ethan and Red Crown on 386.6 mcs. Alternate frequency will be 253.5 mcs. Aircraft will report feet wet and give TACAN position if possible. Calls to Ethan and Red Crown will be made simultaneously by calling "Ethan - Red Crown, this is _____."

e. CTF Procedures:

(1) Aircraft will display appropriate IFF/SIF modes/codes at all times.

(2) Red Crown will identify Air Force mission aircraft entering the PIRAZ from the south by correlation of the IFF/SIF Mode II Codes with the flight call sign and the position provided by Panama CRC.

(3) USN aircraft outbound from the target area toward the Gulf of Tonkin will check in with Red Crown on 386.6 mcs. If unable to contact Red Crown, aircraft will check in with Ethan on 386.6 (alternate 253.5) and report feet wet when over the coastline and heading seaward. Ethan will cross-tell this information to Red Crown.

f. Special Procedures:

(1) Flights, which by the nature of their mission must repeatedly cross the coastline or make multiple entries and exits of the PIRAZ, will be required to check in initially and check out only upon final exit from the zone. These flights must be indicated on frag order.

(2) Where the element of surprise is considered essential and adherence to normal IFF/SIF and/or communications procedures would jeopardize or compromise the mission, the unit concerned may request exemption to the procedures established for air operations over the Gulf of Tonkin. Requests will be submitted by message to

~~SECRET~~

GEA-7

Tab A to
Annex E to
Appendix G

~~SECRET~~

d. Task Force 77 will provide augmenting personnel to Panama CRC to assist in providing cross-tell requirements.

e. Big Eye (Ethan) and PIRAZ (Red Crown) will cross-tell as much track information as is possible on hostile and unidentified (bogey) tracks. Reports will include contact position in GEOREF grid, course, speed, altitude and composition. Initial reports will contain evaluated information and will not be delayed. Amplifying reports will be made providing additional information as available and tracks will be updated every two minutes. Big Eye will pass friendly track information on secure voice circuits only. PIRAZ will provide information on any track which it holds to Big Eye upon request. Tracks provided to PIRAZ by Big Eye shall, if not held by PIRAZ, be entered into the NTDS and will be transmitted on links 11 and 14. Cross-tell will be accomplished on HF 8615 kc (Primary), UHF 386.6 mcs (Secondary) and UHF 253.5 mcs (Tertiary). When LUZON Radio Relay Aircraft (RRA) with additional relay equipment become available, Big Eye and PIRAZ shall have common UHF transmit/receive frequencies and Tactical Air Control Center (North Sector) will transmit/receive on both sets of frequencies. This will allow three-way UHF relay. UHF will then become primary for cross-tell and HF will be secondary.

8. (S) CAP Assignment. During periods of increased tension when air attack is deemed imminent, all available interceptor aircraft will be employed to defend U.S. forces and facilities. This may involve passing control of Navy aircraft to shore based radar facilities or passing control of USAF aircraft to shipboard facilities. All requests for assistance will be honored to the extent feasible without degrading the defensive capabilities of the parent force to an unacceptable degree.

9. (S) Air Operations Proximal to the DMZ. Strike and armed reconnaissance aircraft will not approach closer than 20 nautical miles to the DMZ unless under positive control, and in no case will approach be closer than five nautical miles to the DMZ. The CRP at Dong Ha, Waterboy, can be contacted on its Primary or Secondary air control frequency for position information and vector. In the event Waterboy cannot be contacted or is unable to provide assistance, Panama CRC will be contacted on its Primary or Secondary air control frequency to furnish the required control. (Note: These procedures do not apply to air operations within the DMZ when so ordered and authorized.)

~~SECRET~~

GEA-5

Tab A to
Annex E to
Appendix G

a. The CRC or CRP will advise the receiving ship via AC or CID net whenever handoff will be required. At this time the flight leaders call sign, the handover point in XY coordinates, and frequency designator will be passed.

(1) Air control designators and frequencies are:

Control Facility	Designator - Frequency	Designator - Frequency
Panama CRC	Primary 367.8	Secondary 376.9
Terbooy CRP	Primary 269.6	Secondary 375.7
Chan (AEW&C)	Primary 257.0	Secondary 271.8
Gold Crown PIRAZ Unit)	Primary 386.6	Secondary 291.4

b. The receiving ship will report when positive radar and radio contact are achieved and assure control and surveillance concurrently.

c. Return of USAF aircraft or handover of USN aircraft to CRC or CRP control will be accomplished in the same manner as described in paragraphs a and b, above.

7. (S) Air Defense Cross-tell Criteria:

a. Navy units will exchange information via cross-tell net with appropriate CRC's on all special interest, unknown or hostile tracks utilizing XY coordinates. If continuous track data is no longer required, a cease tell will be passed.

b. Panama CRC will cross-tell all hostile, unidentified and unknown tracks which pose a threat to U.S. or friendly forces.

c. Tactical Air Control Center (North Sector), call sign Motel will cross-tell all Project Hammock tracks to AW. Tracks will be designated with the same code employed by CTU 77.0.1 using numbers 51-99 of the SAR destroyers number block. CTF 77 will provide new AAW brevity codes when necessary.

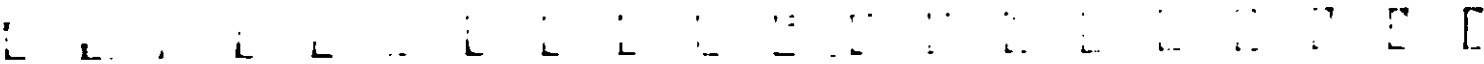

~~SECRET~~

(4) AEW&C - Airborne Early Warning and Control provided by EC-121 aircraft. (Call sign: Ethan)

5. (S) Concept of Operations:

a. U.S. air assets assigned to the conduct of missions in SEASIA are derived from shore-based and ship-based aircraft. The large number of friendly aircraft operating over North Vietnam and the northerly movement of TF 77 units into the Gulf of Tonkin, coupled with more active aggressive operations by North Vietnam aircraft, necessitates the exchange of information between 7AF and CTF 77 of friendly aircraft operating in this hostile environment. Information on all friendly aircraft operating over the Gulf of Tonkin and adjacent land areas of North Vietnam must be known to assure enemy aircraft can be identified and a satisfactory defense posture realized.

b. Joint USAF/USN air operations over Laos or South Vietnam will be properly coordinated to preclude mutual interference.

c. When aircraft operate out of range of their usual radar control facilities, it is desirable that control and surveillance be assumed by another facility which has the aircraft within radar range. Control as used in this agreement will be exercised only when control is passed from the commander normally having control, or when in an emergency situation, the flight leader over whom control is desired is agreeable to such assumption of control.

d. In the event of hostile air attack on U.S. forces or facilities, all aircraft may be required to participate in a coordinated effort under control of either ship or shore based radar.

6. (S) Control Procedures: Aircraft control procedures are prescribed in Air Force Manual 3-16, Standard Tactics for Air Defense, and CTF 77 Ser 77/0028 23 Sep 65 (OPORD 320-66). The following handoff procedures for transferring radar control between control facilities, based on the above references, are established.

~~SECRET~~

GEA-3

Tab A to
Annex E to
Appendix G

~~SECRET~~

TAB A TO ANNEX E TO APPENDIX G

MEMORANDUM OF OPERATIONAL PROCEDURAL AGREEMENT
BETWEEN
COMMANDER 7TH AIR FORCE
COMMANDER TASK FORCE 77

SUBJECT: (C) Agreement for Joint USAF/USN control and coordination of friendly air operations in the airspace of Laos, North and South Vietnam and the adjacent seas.

1. (U) Purpose. Provide essential background facts and disseminate information concerning basic policies, procedures and responsibilities associated with the control of friendly aircraft and cross-tell of track information necessary for the defense of U.S./friendly forces and facilities against air attack.

2. (U) Implementation. This agreement becomes effective when signed/authenticated by the Commander 7th Air Force and Commander Task Force 77 or their designated representatives.

3. (C) Terms of Reference:

a. COMUSMACV is a subordinate unified commander under CINCPAC. Commander 7AF is the designated Air Force Component Commander to COMUSMACV. In this capacity Commander 7AF will conduct and coordinate offensive and defensive air operations, tactical airlift, air traffic control, search and rescue, close air support and reconnaissance. (Ref CINCPAC OPLAN 32-64 Annex C, and MACV DIR 95-4).

b. The responsibility for U.S. Air Defense in Mainland Southeast Asia will be discharged by CINCPACAF through his Mainland Southeast Asia Air Defense Region Commander, Commander 7AF. (Ref CINCPAC OPLAN 1-65 Annex I).

c. Commander Task Force 77 is responsible to Commander Seventh Fleet for control of U.S. Navy attack carrier aircraft operations in WESTPAC and especially within the Southeast Asia region.

(1) A Positive Identification and Radar Advisory Zone (PIRAZ) has been established, encompassing fleet operations in which positive identification of air traffic is

~~SECRET~~

GEA-1

Tab A to
Annex E to
Appendix G

~~SECRET~~

of information and standardized communications, and IFF/SIF procedures. Tab A is a copy of the Memorandum of Operational Procedural Agreement between CMDR 7th AF and CTF-77.

(3) Flights through RPs assigned to another commander do not require clearance above 14,000 feet. Below this altitude, Navy aircraft obtain clearance from 7th AF GCI or ABCCC controllers. CMDR 7th AF advises CTG-77.0 of intended tracks, times, and altitudes. As a matter of practice, TF-77 aircraft do not operate through RPs V and VI A and all 7th AF aircraft transits through the Tonkin Gulf are conducted in accordance with established check-in/check-out procedures through PIRAZ.

e. CMDR 7th AF/CTF-77 Coordination Committee. The principle organization in which coordination procedures between CMDR 7th AF and CTF-77 are developed, reviewed and/or revised is the CMDR 7th AF/CTF-77 Coordination Committee. This committee meets monthly or as required. The basic letter of agreement is at TAB A.

~~SECRET~~

GE-5

Annex E to
Appendix G

photo collection is processed by Marine units at Danang. Photo recce collected in RP I or in other areas of North Vietnam, which are considered to be of interest to other services, is forwarded by message photo interpretation report and by passing a copy of the negatives. Marine photo collection is retained at Danang except for that portion forwarded to higher echelons as matters of special interest.

(3) ELINT requirements of the various services are generally identical. The ELINT vehicles of the various services vary in capability. The total capability of all collection vehicles covers the entire spectrum of ELINT collection requirement. The accuracy and detail of certain types of ELINT, however, is subject to equipment limitations. The number of collection vehicles available in the services has limited the total hours of coverage per day for certain ELINT information. Volume III discusses the collection and distribution of special intelligence.

(4) ECM vehicles are in the same category as ELINT collection vehicles and in many cases are in the same airframe e.g., EF-10, EA-6A, EKA-3B, and EA-1A. Requests for use of the resources of the various services are made by appropriate authority and filled in order of priority by the desired equipment.

d. Other Procedures

(1) Lucrative targets of a fleeting nature may be attacked by 7th AF or TF-77 aircraft when located, but must be reported to the commander having area responsibility.

(2) Coordination and identification of friendly air operations in the airspace of Laos, North and South Vietnam and adjacent seas are effected through ADIZ and PIRAZ procedures. Both ADIZ and PIRAZ are effective in defined areas and are predicated on identification by flight plans and IFF/SIF. They provide for mutual support, crosstell

SECRET

disruption to TF-77 operation. Pre-strike coordination is continually exercised through the 7th FLT Mobile Air Coordination Team Elements referenced in paragraph 2a above.

c. Distribution of Tactical and Target Intelligence Information and Materials

(1) The determination of requirements for, and collection of, tactical and target intelligence is an individual service responsibility which generally parallels the geographic area of responsibility. The services have similar photo reconnaissance aircraft. There are minor variations in the capability of installed camera equipment. Various ELINT gathering capabilities are unique to one or more of the individual services.

(2) The assessment of photo intelligence follows individual service channels.

(a) Navy photo collection is initially processed aboard the CVA. The film is then forwarded to FICPACFAC, Cubi Point, P.I. for further assessment and analysis and then to FICPAC in Hawaii for detailed assessment and analysis. At all stages the items determined to be of interest to any other service is extracted and passed via a message photo interpretation report and by passing a copy of the negative.

(b) The USAF photo collection is initially processed at the home base of the photo recce aircraft, (Udorn, Thailand or Tan Son Nhut, South Vietnam). Second echelon assessment is accomplished at Tan Son Nhut. The film is then sent to Clark AFB, P.I., for further assessment and finally to PACAF headquarters in Hawaii for detailed assessment and analysis. At all stages, items determined to be of interest to any other service is extracted and passed via message photo interpretation report and by passing a copy of the negative.

(c) The USMC photo recce effort is generally limited to South Vietnam and RP I. The Marine

~~SECRET~~

ANNEX E TO APPENDIX G
COORDINATION PROCEDURES

1. (S) Functions Requiring Coordination Between
7th AF and TF-77

a. TF-77 offensive combat missions in areas assigned to 7th AF. Seventh AF offensive missions in areas assigned to CTF-77.

b. Aircraft identification, advisory service and control particularly within defensive and identification zones. As feasible and necessary, this includes:

(1) Control of defensive systems including air-to-air and surface-to-air systems.

(2) Assistance to fighter aircraft in the air-to-air combat role in target areas.

(3) Enroute flight following and aircraft separation.

(4) Assistance to strike aircraft in and enroute to target areas.

c. SAR and RESCAP missions and procedures.

d. Distribution of tactical and target intelligence information and materials.

e. Standardization of ECM procedures, warning systems procedures, and code words.

f. Procedures for requesting services by forces of the other commander.

2. (S) Coordination Procedures Now in Effect

a. Navy aircraft in USAF Route Packages.

CTF-77 strike/armed reconnaissance (recce) missions scheduled for or diverted to RP 1, Laos, or South Vietnam will use normal procedures established

~~SECRET~~

GE-1

Annex E to
Appendix G

~~SECRET~~

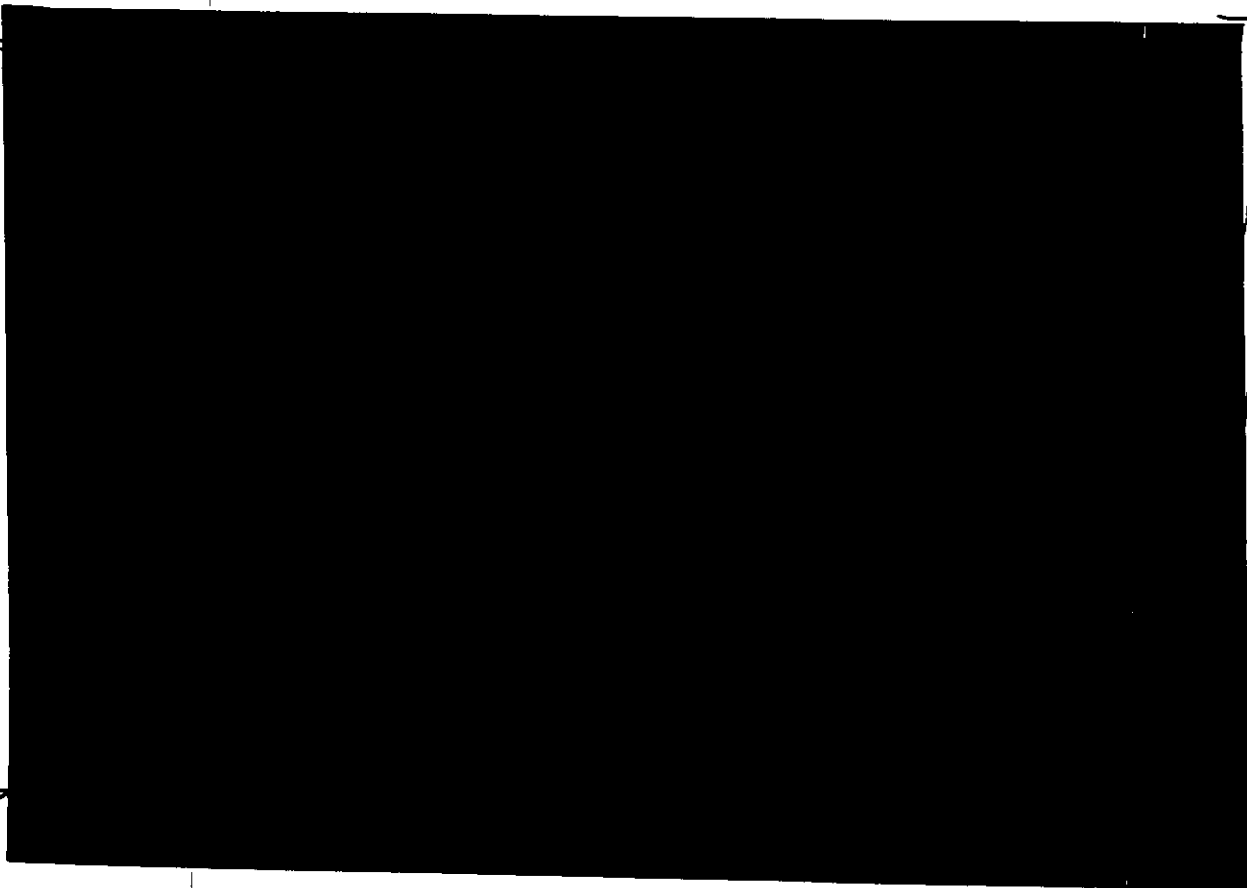

NSA

~~SECRET~~

GD-39r

Table 21 to
Annex D to
Appendix G

L E T T E R S T O B E F O R G O T T E N

SECRET

NSA

NSA

SECRET

GD-39a

Table 20 to
Annex D to
Appendix G

SECRET

SECRET

NSA

NSA

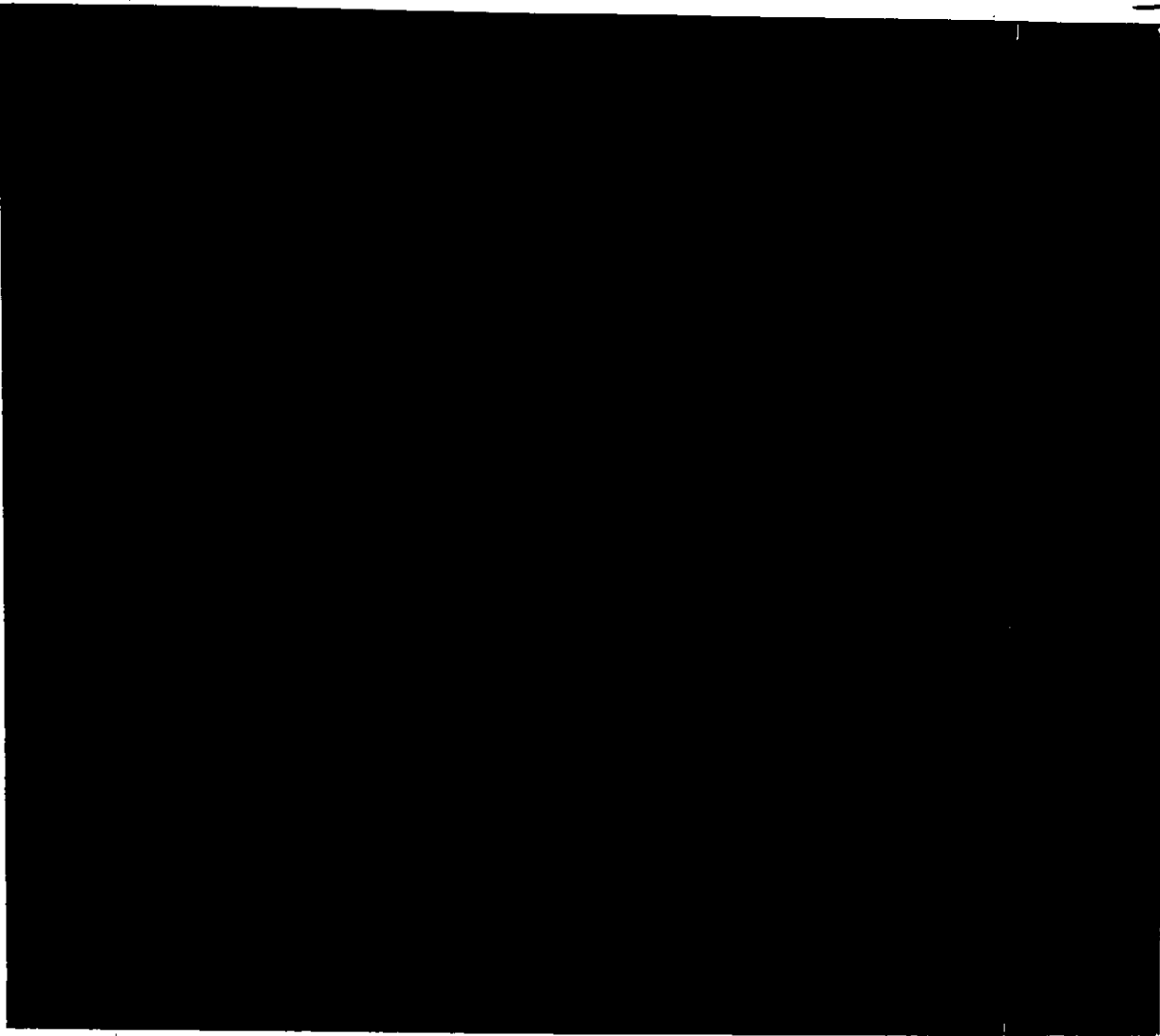

SECRET

GD -39p

Table 19. to
Annex D to
Appendix G

SECRET

~~SECRET~~

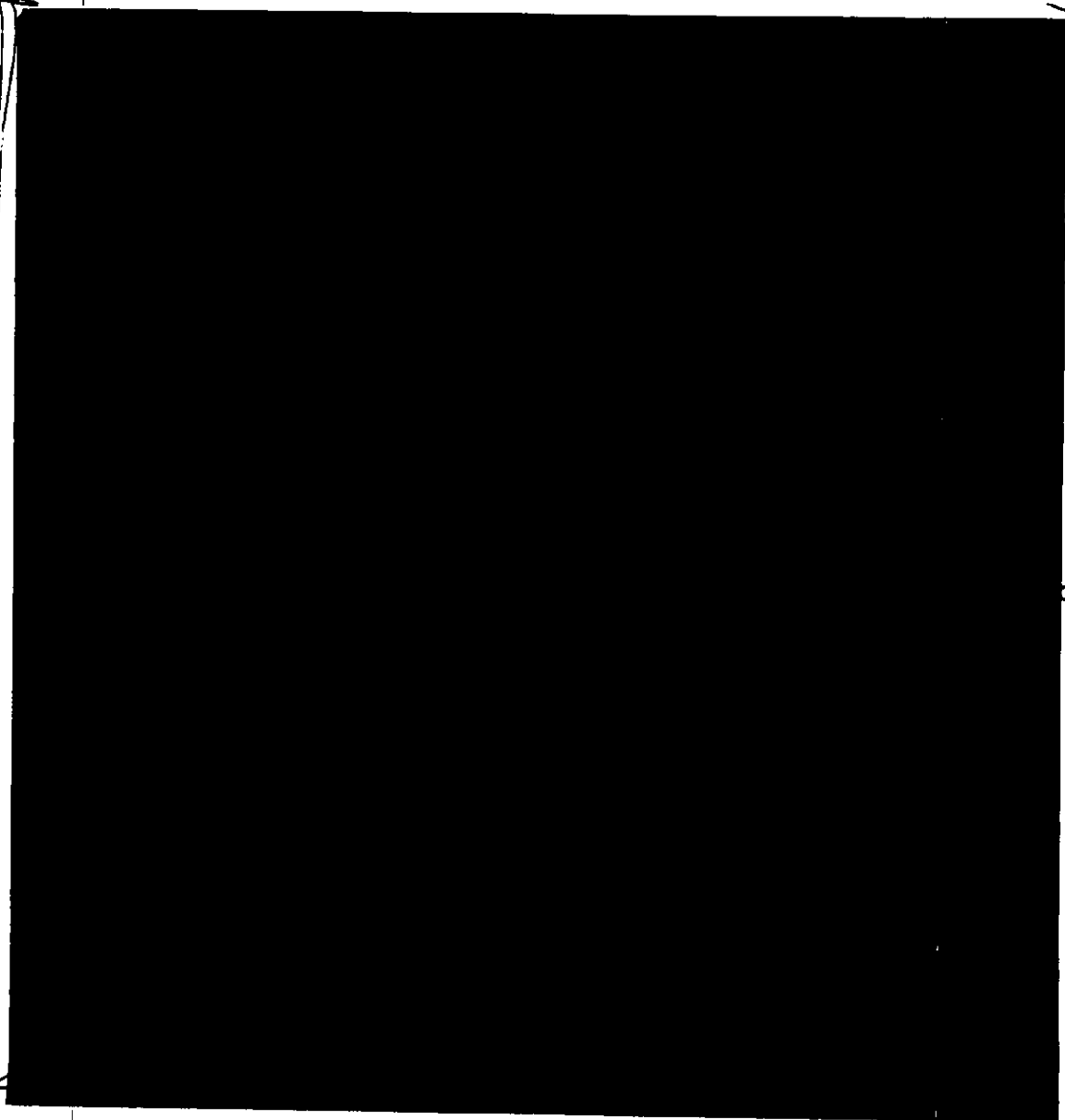

NSA

NSA

~~SECRET~~

GD-390

Table 18 to
Annex D to
Appendix G

~~SECRET~~

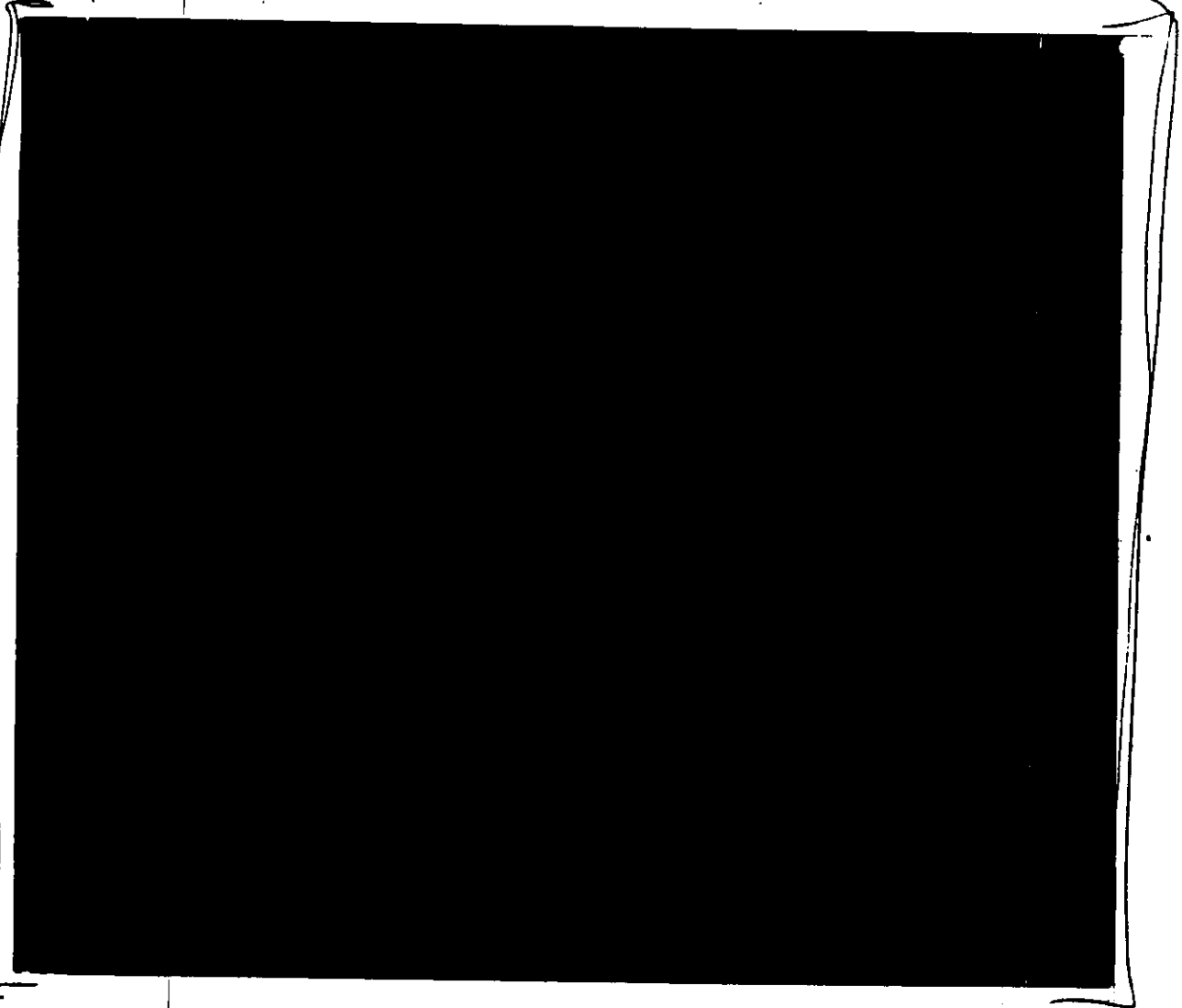

ASN

ASN

~~SECRET~~

GD-39n

Table 17 to
Annex D to
Appendix G

SECRET

~~SECRET~~

NSA

NSA

~~SECRET~~

GD-39m

Table 16 to
Annex D to
Appendix G

SECRET

~~SECRET~~

852

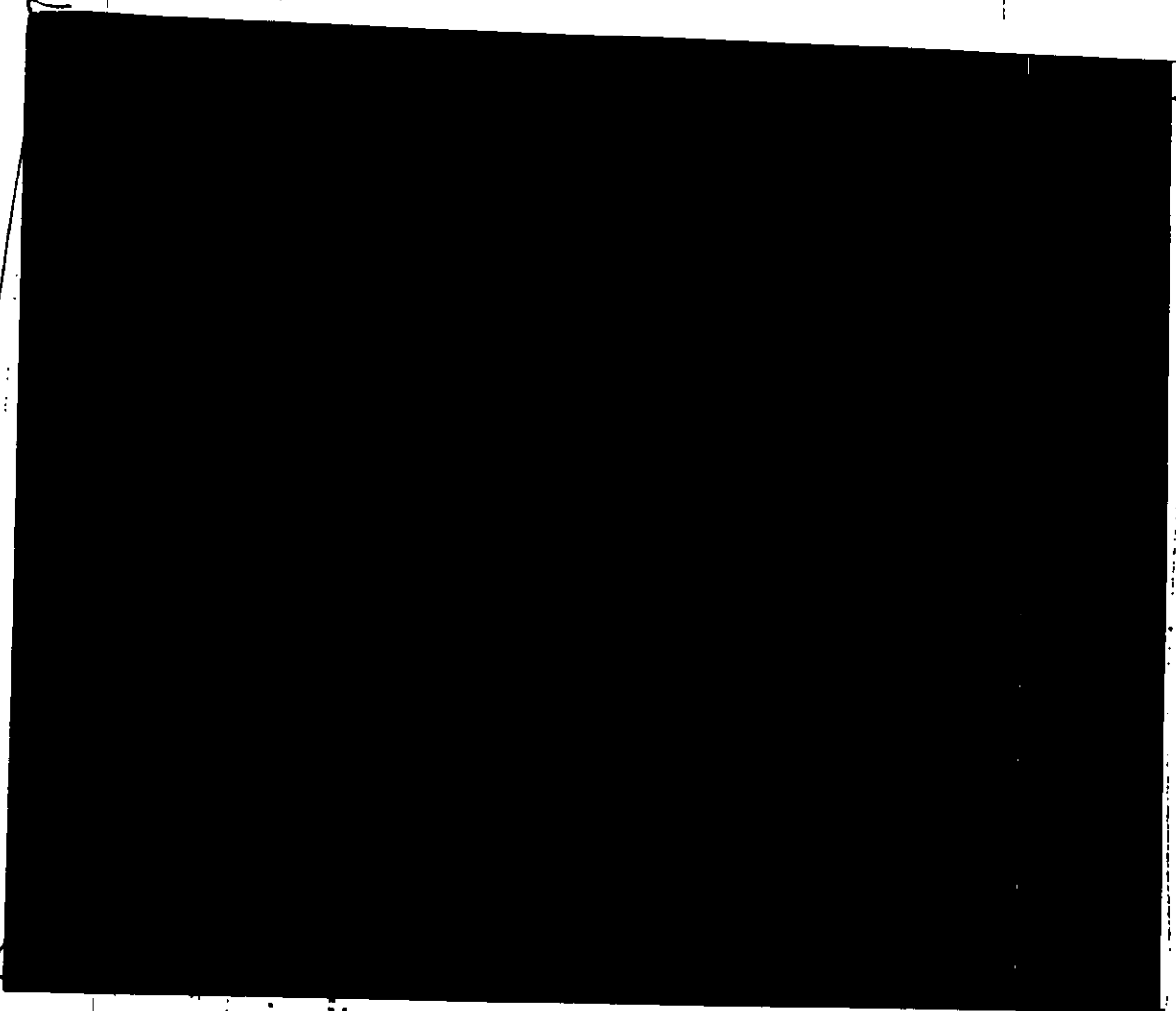

NSA

~~SECRET~~

GD-391

Table of Contents
Annex B
Appendix C

SECRET

~~SECRET~~

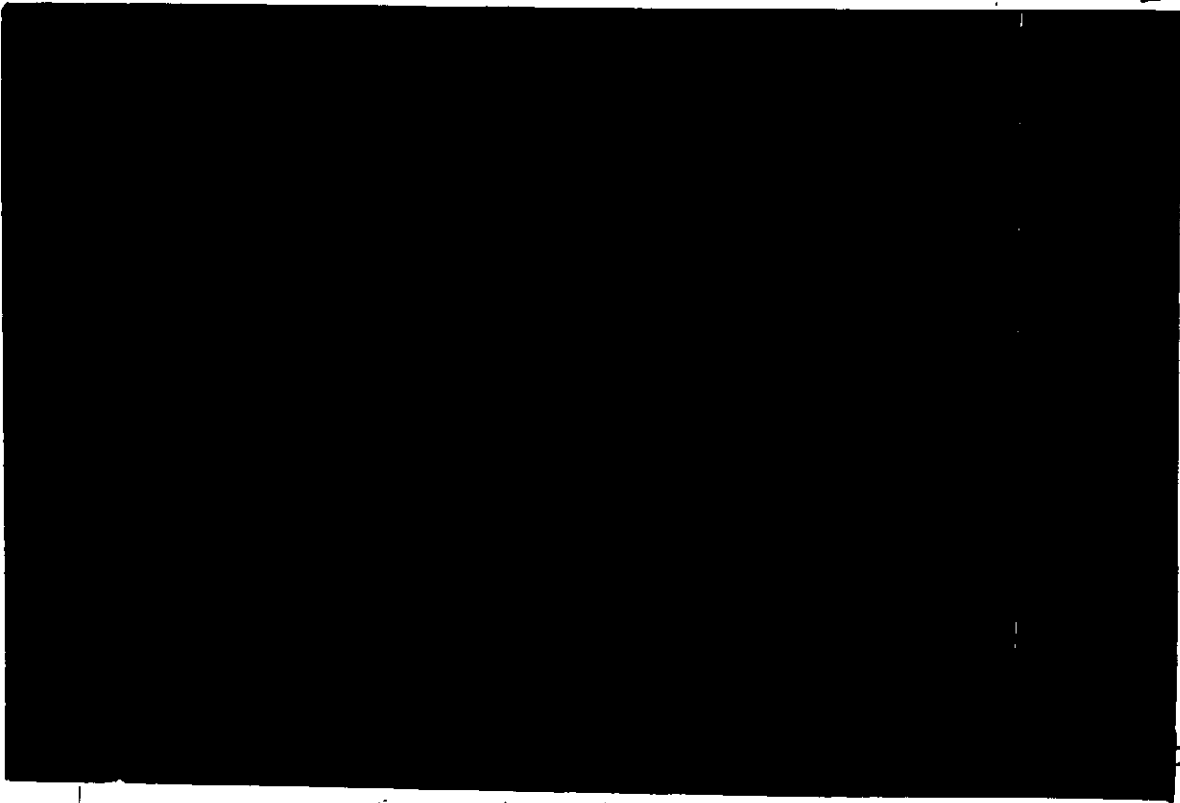

NSA

NSA

~~SECRET~~

GD-39k

Table 14 to
Annex D to
Appendix G

1 2 3 4 5 6 7 8 9 10 11 12 13 14 15 16 17 18 19 20

SECRET

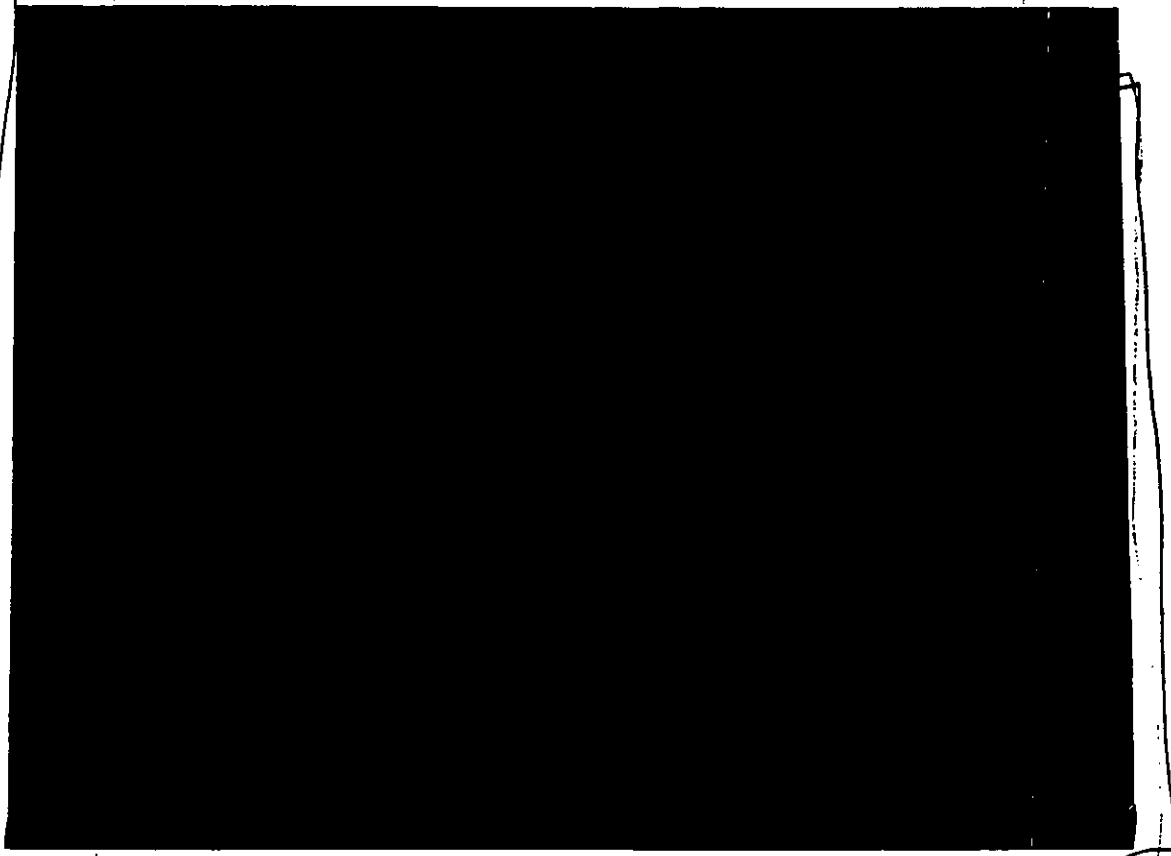

USA

SECRET

GD-391

Table 12 to
Annex D to
Appendix C

U. S. G. O. P. R. I. N. T. I. O. N. A. L. S. E. C. R. E. T. A. R. Y.

~~SECRET~~

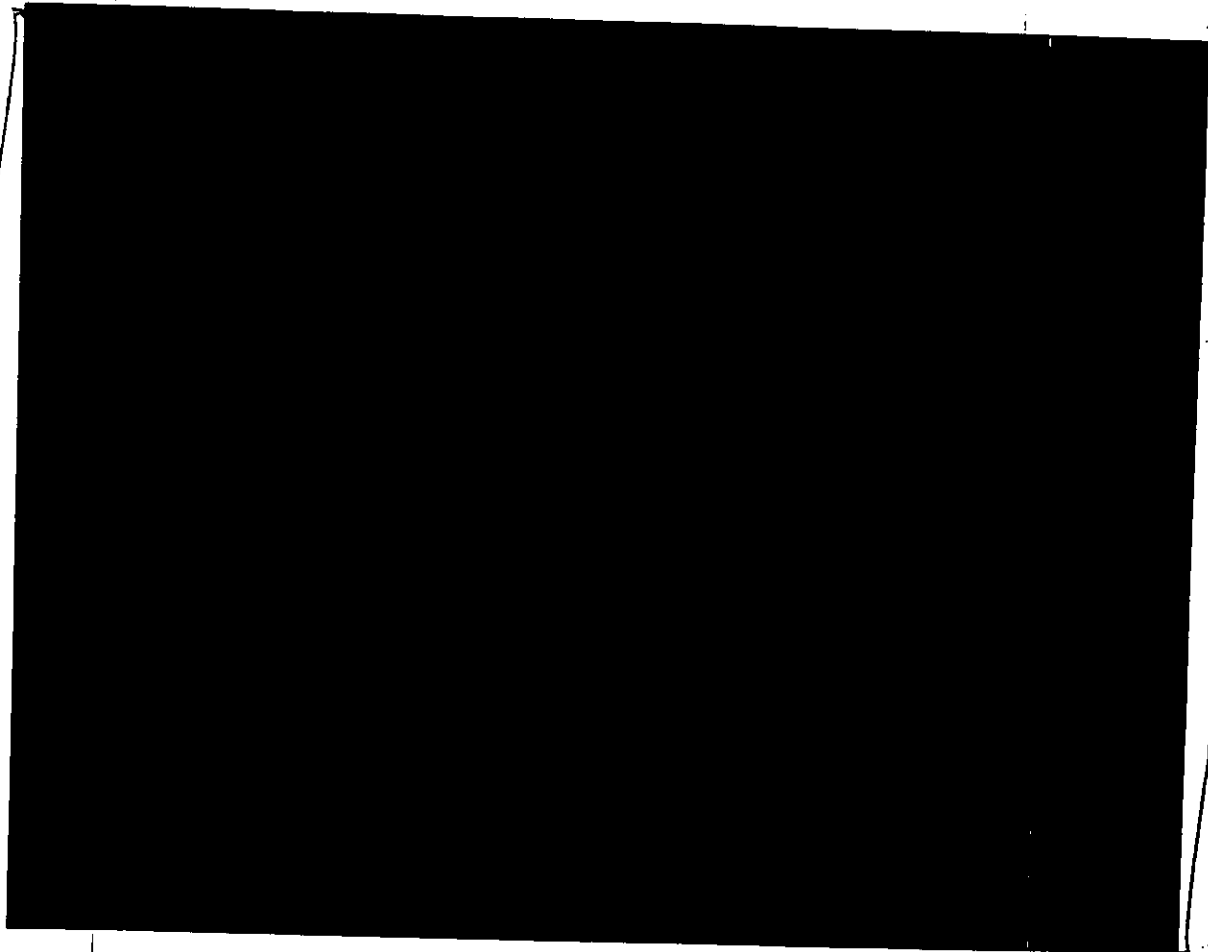

NSA

NSA

~~SECRET~~

GD-39g

Table 10 to
Annex D to
Appendix G

U.S. GOVERNMENT PRINTING OFFICE: 1975 O - 300-000

SECRET

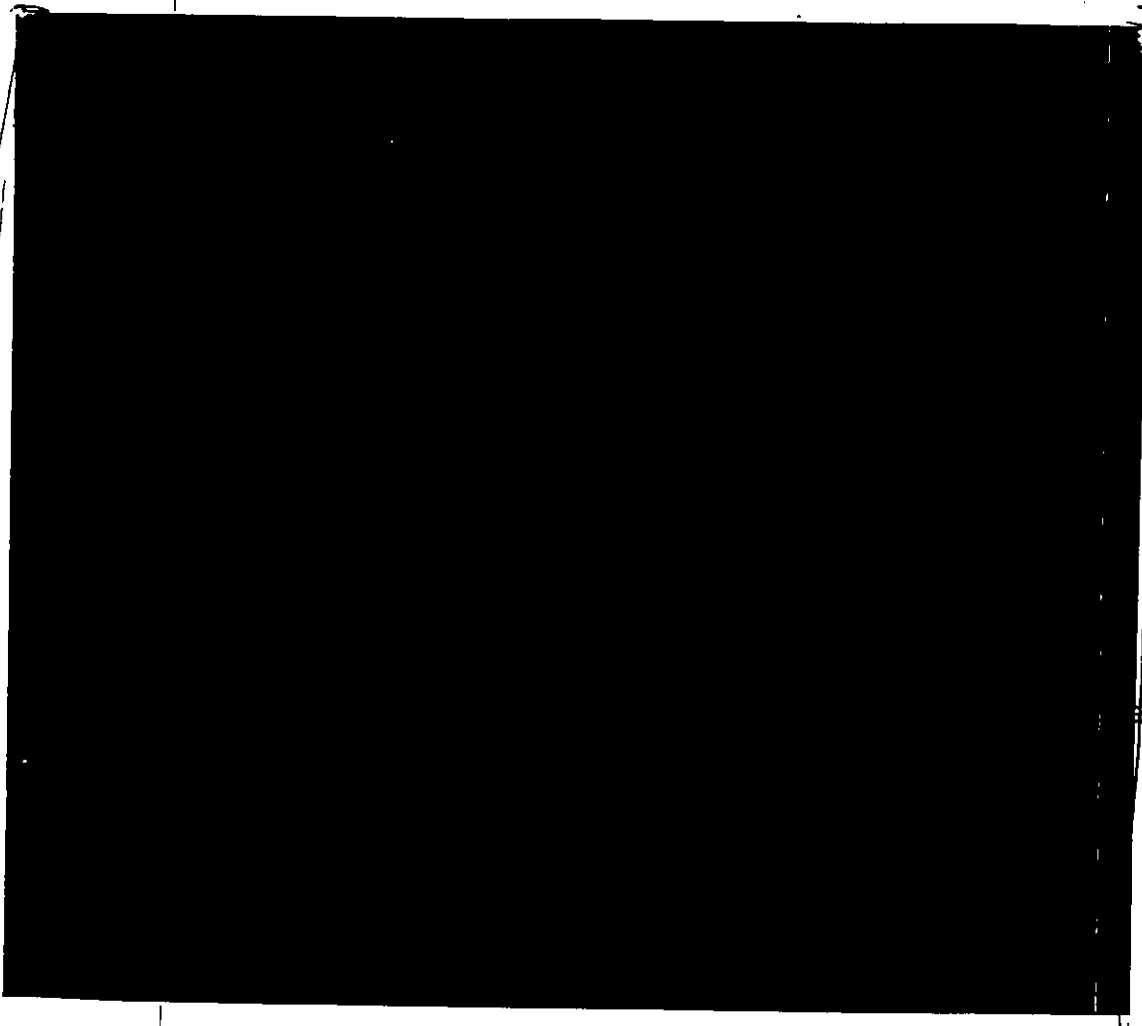

NSA

SECRET

GD-39f

Table 9 to
Annex D to
Appendix G

SECRET

~~SECRET~~

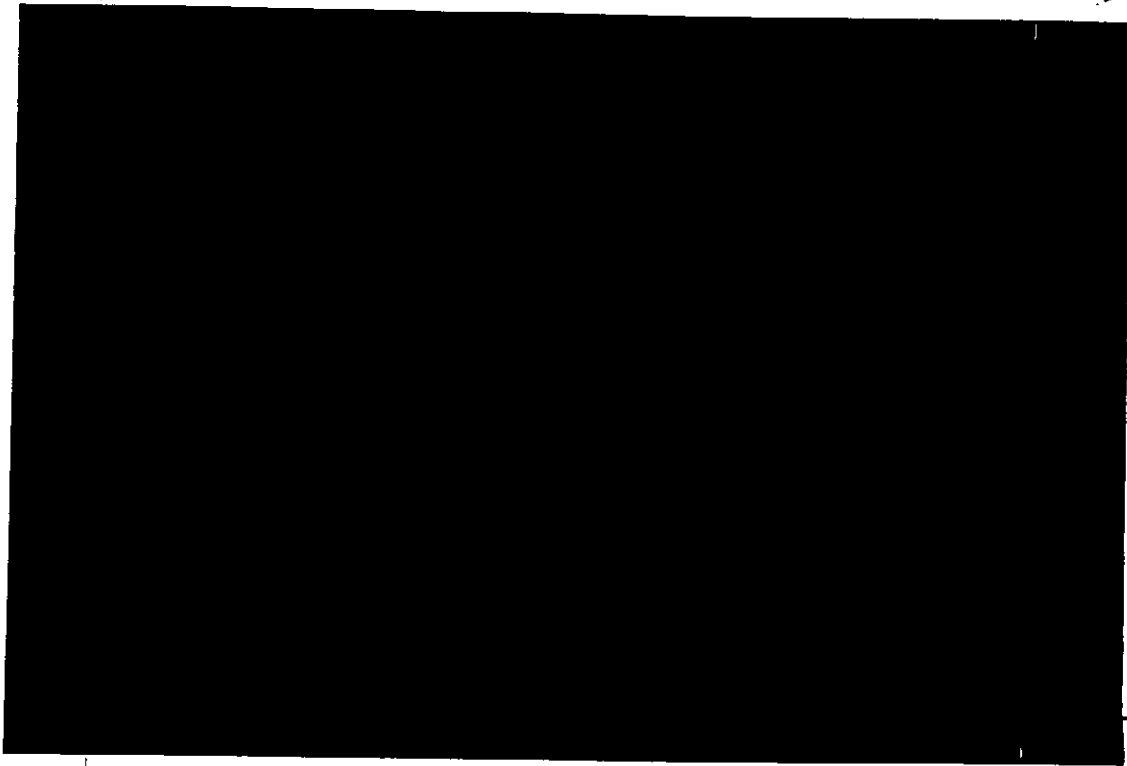

2/5 9

~~SECRET~~

GD-39e

Table 8 to
Annex D to
Appendix

~~SECRET~~

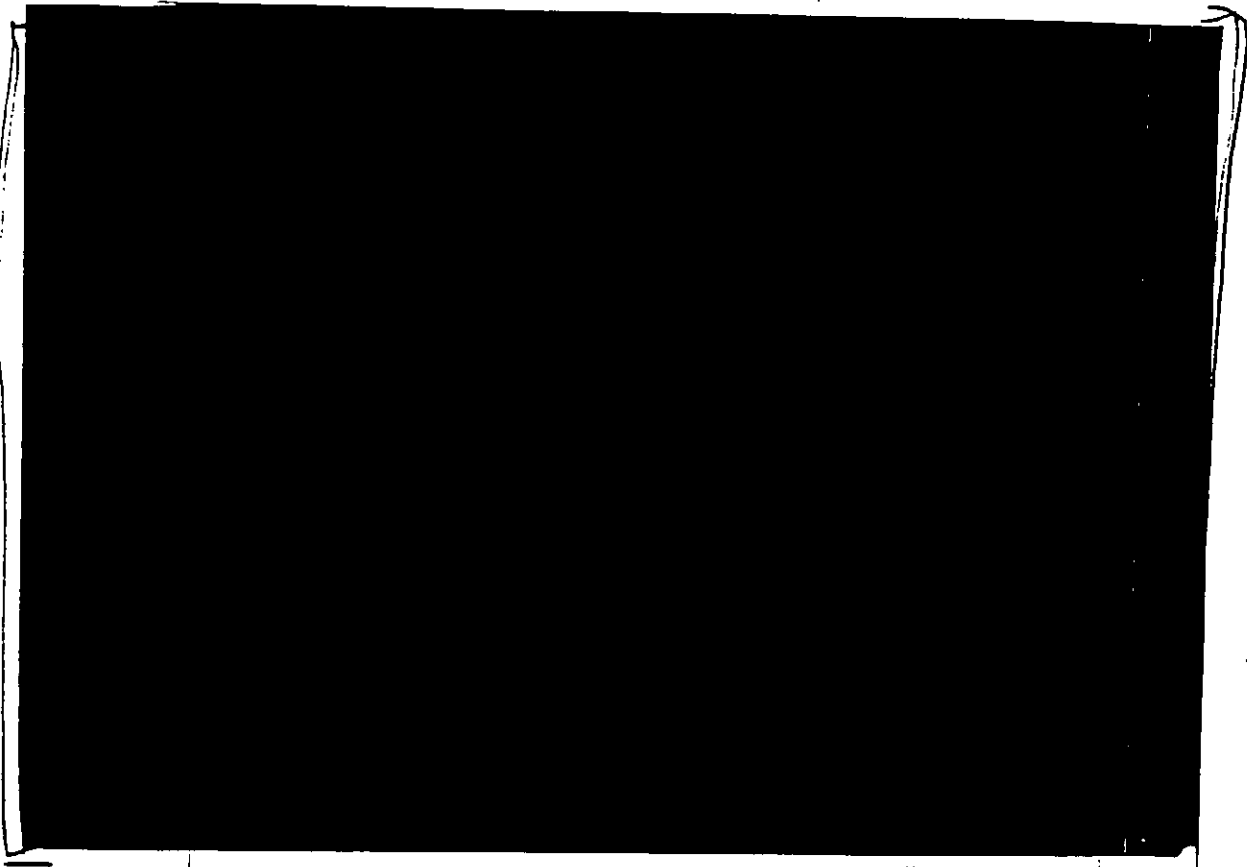

NSA

~~SECRET~~

GD-39d

Table 7 to
Annex D to
Appendix C

~~SECRET~~

ASN

ASN

~~SECRET~~

GD-39c

Table 6 to
Annex D to
Appendix G

SECRET

~~SECRET~~

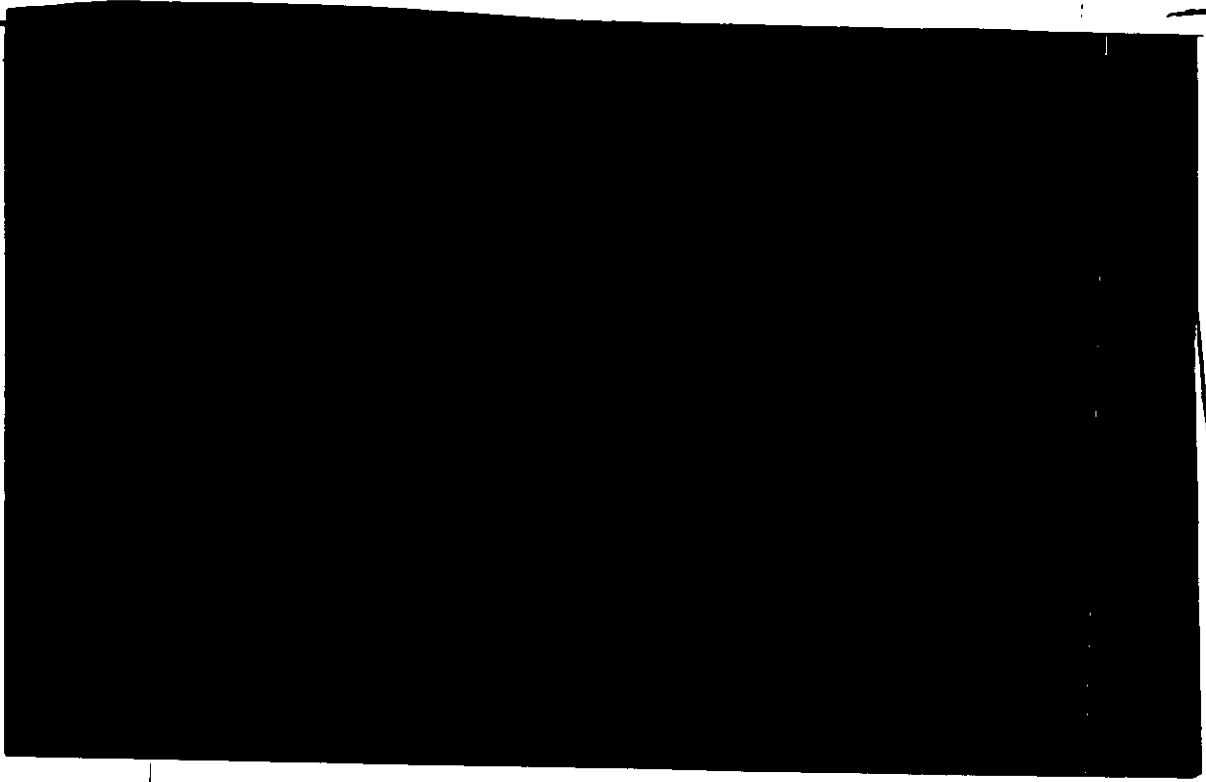

ASIA

ASIA

~~SECRET~~

GD-39b

Table 5 to
Annex D. to
Appendix G

~~SECRET~~

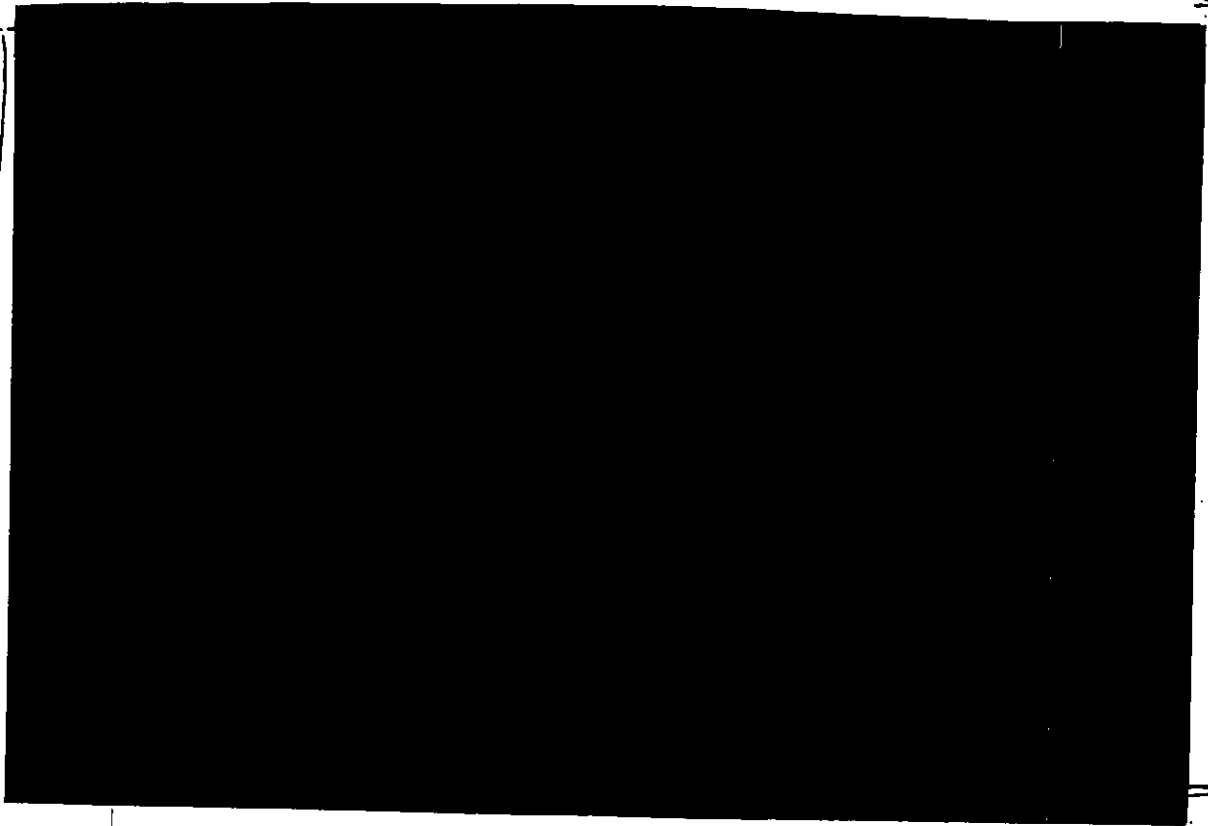

NSA

~~SECRET~~

GD-39a

Table 4 to:
Annex D to
Appendix G

ANNEX D TO APPENDIX G

US CRYPTOGRAPHIC EQUIPMENT
CURRENTLY IN USE^{a/}

HY-2A	KW-8
KG-13/13A	KW-26
KG-14	KW-37
KG-22	KY-3A
KG-30	KY-8
KG-31	KY-9
KL-7/7A	KY-28
KL-47	KY-38
KW-7	

a/ See Tables 4 through 21

CONFIDENTIAL

<u>SYSTEM SYMBOL</u>	<u>DESCRIPTION</u>	<u>EQUIPMENT</u>
N	ON-LINE MULTI-CHAN BCST RECEIVE SYSTEM (2-8 CHANNELS)	1 UGC-1, 2 TT-298, 2-8 TT-192, 2-3 KWR-37
P	ON-LINE MULTI-CHAN TELETYPE SYSTEM DUPLEX (1-8 CHANNEL)	2 UCC-1, 1-8 TT-298, 2-16 KW-7, 1-8 UGC-6

CONFIDENTIAL

GD-38b

Table 3 to
Annex D to
Appendix G